

# Serene

---

CHESTS / BEDSIDE CABINETS /  
WARDROBES / OVER-THE-BED TABLE

Effective: March 1, 2025

T R I N I T Y

**Date:**

**Page:**

**Modification:**

**Description:**

---

### Casegoods Laminates

Due to variations in screen displays, digital laminate images shown here may not match actual laminate samples exactly. These images are for color reference only. If you require an actual laminate sample, please contact your representative or contact customer service.

#### Laminates For Casegoods (Serene Collection)



Wilsonart  
Fusion Maple

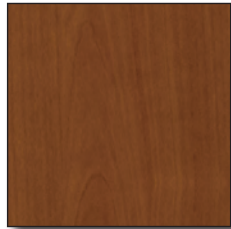

Wilsonart  
Blitmore Cherry

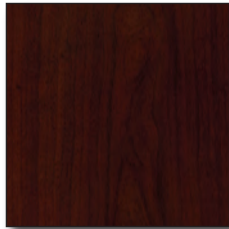

Wilsonart  
Empire Mahogany

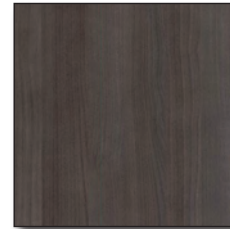

Wilsonart  
Skyline Walnut



Wilsonart  
Ebony

NOTE: Serene chassis are TFL with matching HPL top option. Additional colors available. Please contact Customer Service for more information.

#### Laminates For Over-The-Bed Table Top (Serene Collection)



Nevamar  
Clear Maple



Wilsonart  
Fusion Maple



Wilsonart  
Quartered Oak



Wilsonart  
Bannister Oak



Wilsonart  
Solar Oak



Wilsonart  
Nepal Teak

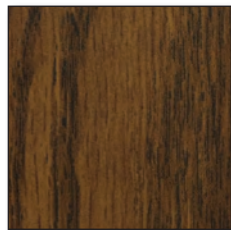

Wilsonart  
English Oak

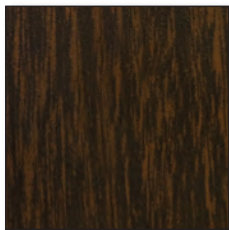

Wilsonart  
Gunstock Walnut

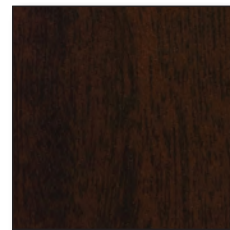

Wilsonart  
Figured Mahogany



Wilsonart  
Wild Cherry

NOTE: Over-The-Bed Table top laminates are available in (10) standard colors, including Fusion Maple. Blitmore Cherry, Empire Mahogany, Skyline Walnut, and Ebony laminates are available as an upcharge. Additional colors and top options available. Please contact Customer Service for more information.

#### Metal Base Finish For Over-The-Bed Table (Serene Collection)

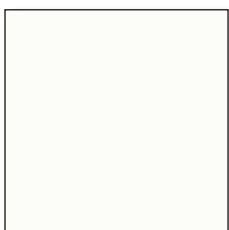

Opal - Standard

NOTE: Over-The-Bed Table metal base is standard in Opal powder coat finish. Other metal base colors are available as an upcharge with qualifying quantities. Please contact customer service for more information.

Pull Selections

Trinity offers (3) pull selections for the Serene Collection.

P02 Bow Pull - Matte Black Finish (STANDARD PULL)

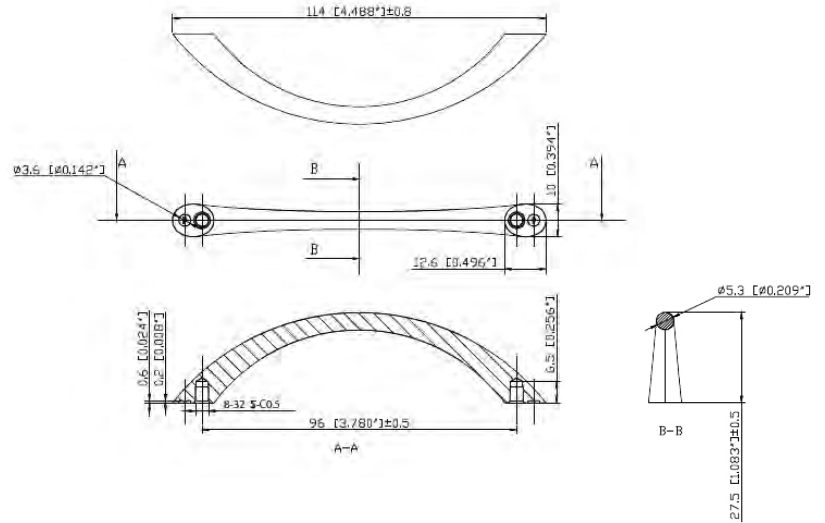

P03 Bow Pull - Brushed Nickel Finish (OPTIONAL PULL - NO UPCHARGE)

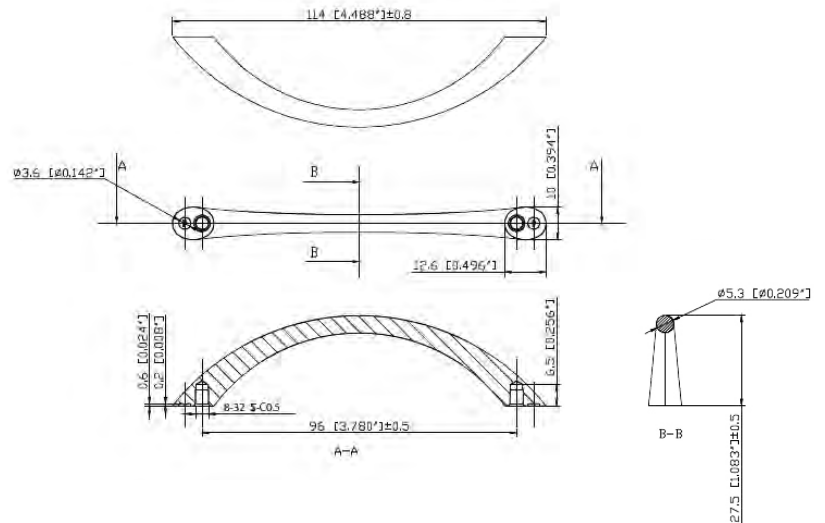

P01 Bar Pull - Brushed Nickel Finish (OPTIONAL PULL - NO UPCHARGE)

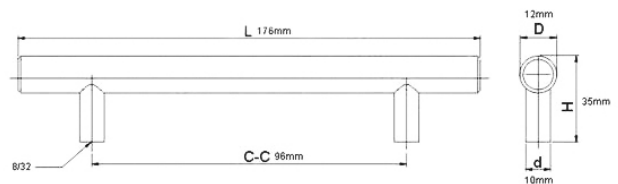



**DESCRIPTION:**

- PVC Banded HPL Top Standard
- TFL Chassis Construction w/ Matching 1mm PVC Edges
- White Vinyl Wrapped Drawers
- HD Full Extension Ball Bearing Side Guides
- P02 Matte Black Bow Pull Standard
- Plinth Base Standard
- Tack Glides On Plinth Bases
- Locking Top Drawer (Std. On Drawers)
- Vented Back Panel w/ Black Plastic Wire Grommet
- 10 Year Warranty

**OPTIONS:**

- P01 Brushed Nickel Bar Pull (See Serene Hardware Page)..... n/c
- P03 Brushed Nickel Bow Pull (See Serene Hardware Page)..... n/c
- MLB 2" Dia. x 4" h Matte Black Metal Legs (Set Of 4) ..... \$153
- MLN 2" Dia. x 4" h Nickel Metal Legs (Set Of 4) ..... \$153
- TDPT-1 Thermofoil Drip Proof Top (Chests) ..... Call For Pricing
- SDPT-1 Solid Surface Drip Proof Top (Chests) ..... Call For Pricing
- RDL-1 Removable Drawer Liner (1 Per Drawer - Chests) ..... Call For Pricing

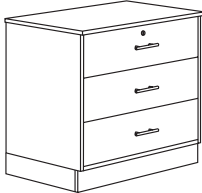
Specify Laminate Color (See Serene Casegoods Laminates Page)



CHESTS	ITEM #:	SPECIFICATIONS   LIST PRICES:
<p><b>3 DRAWER CHEST</b></p> 	<p><b>61-128</b></p>	<p><b>Overall:</b> 33.5"w 21.5"d 30"h <b>Weight:</b> 110 lbs.</p> <hr/> <p><b>LIST PRICE</b></p> <hr/> <p>1817 <i>PVC Banded HPL Top / Plinth Base</i></p>
<p><b>4 DRAWER CHEST</b></p> 	<p><b>61-152</b></p>	<p><b>Overall:</b> 33.5"w 21.5"d 38"h <b>Weight:</b> 132 lbs.</p> <hr/> <p><b>LIST PRICE</b></p> <hr/> <p>2178 <i>PVC Banded HPL Top / Plinth Base</i></p>

**DESCRIPTION:**

- PVC Banded HPL Top Standard
- TFL Chassis Construction w/ Matching 1mm PVC Edges
- White Vinyl Wrapped Drawers
- HD Full Extension Ball Bearing Side Guides (Drawers Only)
- P02 Matte Black Bow Pull Standard
- Plinth Base Standard
- Tack Glides On Plinth Bases
- European Concealed Hinges, 90° Opening (Doors Only)
- Locking Top Drawer (Std. On Drawers)
- Vented Back Panel w/ Black Plastic Wire Grommet
- 10 Year Warranty

**OPTIONS:**

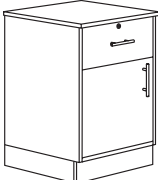
- P01 Brushed Nickel Bar Pull (See Serene Hardware Page)..... n/c
  - P03 Brushed Nickel Bow Pull (See Serene Hardware Page)..... n/c
  - CAS-NL Non-Locking Swivel Casters (Set Of 2) ..... \$305
  - CAS-L Locking Swivel Casters (Set Of 2) ..... \$305
  - MLB 2"Dia. x 4"h Matte Black Metal Legs (Set Of 4) ..... \$153
  - MLN 2"Dia. x 4"h Nickel Metal Legs (Set Of 4) ..... \$153
  - TDPT-2 Thermofoil Drip Proof Top (Bedside Cabinets) ..... Call For Pricing
  - SDPT-2 Solid Surface Drip Proof Top (Bedside Cabinets) ..... Call For Pricing
  - RDL-2 Removable Drawer Liner (1 Per Drawer - Bedside Cabinets) ..... \$127
  - DOL Drawer/Door Lock (61-232 / 61-801 / 61-803)..... \$135
- Specify Laminate Color (See Serene Casegoods Laminates Page)

BEDSIDE CABINETS	ITEM #:	SPECIFICATIONS   LIST PRICES:
<p><b>1 DRAWER BEDSIDE CABINET</b></p> 	<p><b>61-222</b></p>	<p><b>Overall:</b> 17"w 21.5"d 30"h <b>Weight:</b> 60 lbs.</p> <p><b>LIST PRICE</b></p> <hr/> <p>1372 <i>PVC Banded HPL Top / Plinth Base</i></p>
<p><b>1 DOOR / 1 DRAWER BEDSIDE CABINET</b></p> 	<p><b>61-232</b></p>	<p><b>Overall:</b> 21.5"w 21.5"d 30"h <b>Weight:</b> 75 lbs.</p> <p><b>LIST PRICE</b></p> <hr/> <p>1440 <i>PVC Banded HPL Top / Plinth Base</i></p>
<p><b>3 DRAWER BEDSIDE CABINET</b></p> 	<p><b>61-233</b></p>	<p><b>Overall:</b> 17"w 21.5"d 30"h <b>Weight:</b> 70 lbs.</p> <p><b>LIST PRICE</b></p> <hr/> <p>1646 <i>PVC Banded HPL Top / Plinth Base</i></p>

**DESCRIPTION:**

- TFL Chassis Construction w/ Matching 1mm PVC Edges
- White Vinyl Wrapped Drawer (61-803)
- HD Full Extension Ball Bearing Side Guides (61-803 Drawer Only)
- P02 Matte Black Bow Pull Standard
- Full Width Metal Coat Rod
- Adjustable Shelf (61-801)
- Plinth Base Standard
- Tack Glides On Plinth Bases
- European Concealed Hinges, 90° Opening (Doors Only)
- Vented Back Panel w/ Black Plastic Wire Grommet
- 10 Year Warranty

**OPTIONS:**

- P01 Brushed Nickel Bar Pull (See Serene Hardware Page)..... n/c
- P03 Brushed Nickel Bow Pull (See Serene Hardware Page)..... n/c
- DOL Drawer/Door Lock (61-232 / 61-801 / 61-803)..... \$135
- RDL-3 Removable Drawer Liner (1 Per Drawer - 61-803 Only)..... Call For Pricing

Specify Laminate Color (See Serene Casegoods Laminates Page)

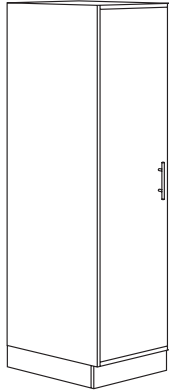
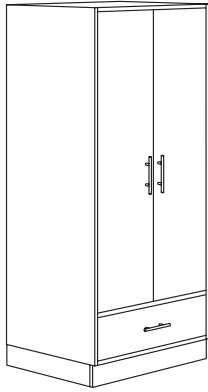
WARDROBES	ITEM #:	SPECIFICATIONS   LIST PRICES:
<p>HALF WARDROBE</p> 	<p><b>61-801</b></p>	<p><b>Overall:</b> 20"w 25"d 71.25"h <b>Weight:</b> 120 lbs.</p> <hr/> <p><b>LIST PRICE</b></p> <hr/> <p>2435 <i>Full Width Coat Rod / Adjustable Shelf / Plinth Base</i></p>
<p>FULL WARDROBE WITH 1 DRAWER</p> 	<p><b>61-803</b></p>	<p><b>Overall:</b> 32"w 25"d 71.25"h <b>Weight:</b> 220 lbs.</p> <hr/> <p><b>LIST PRICE</b></p> <hr/> <p>2743 <i>Full Width Coat Rod / Bottom Drawer (Non-Locking Std.) / Plinth Base</i></p>

**DESCRIPTION:**

**(Over-The-Bed Table: 61-4828)**

- PVC Banded HPL Top Standard
- 40mm Dual Wheel Casters
- Pneumatic Height Adjustment
- Opal Powder Coat Finish Standard



**(STOOLS: 61-1619 / 61-2419)**

- 5 Star Nylon Base w/ Casters
- Non-Tilting Control / Pneumatic Seat Height Adjustment
- Seat / Back: High Density Polyurethane Foam Over Plywood

**OPTIONS:**

- TDPT-3 Thermofoil Drip Proof Top (Over-The-Bed Table Top) ..... Call For Pricing
- SDPT-3 Solid Surface Drip Proof Top (Over-The-Bed Table Top) ..... Call For Pricing

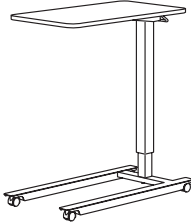
Specify Top Laminate Color (See Serene Casegoods Laminates Page)

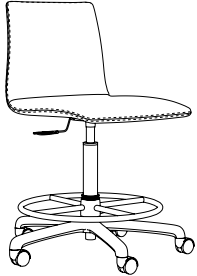
OVER-THE-BED TABLE / STOOLS	ITEM #:	SPECIFICATIONS   LIST PRICES:													
<b>OVER-THE-BED TABLE</b>  	61-4828	<b>Overall:</b> 35"w 18"d 25.5"h - 41.25"h <b>Weight:</b> 30 lbs.  <b>LIST PRICE</b>  1252 <i>PVC Banded HPL Top / Fork Style Base / Pneumatic Height Adjustment</i>													
<b>PHYSICIAN STOOL W/ FULLY UPHOLSTERED ROUND SEAT</b>  	61-1619	<b>Overall:</b> 16"w 16"d 24"h - 30"h <b>Seat:</b> 16"w 16"d 24"h - 30"h				<b>Arm:</b> n/a <b>Weight:</b> 25 lbs.				<b>COM:</b> .75 yds. <b>COL:</b> 13.5					
		COM	COL	1	2	3	4	5	6	7	8	9	10	L1	L2
		497	547	520	531	542	554	565	576	587	598	610	621	645	685
		<i>5 Star Nylon Base w/ Casters / Non-Tilting Control / Pneumatic Seat Height Adjustment</i>													
<b>PHYSICIAN STOOL W/ FULLY UPHOLSTERED SEAT &amp; BACK</b>  	61-2419	<b>Overall:</b> 18"w 22.25"d 35.75"h - 41.75"h <b>Seat:</b> 18"w 17.5"d 22.25"h - 28.25"h				<b>Arm:</b> n/a <b>Weight:</b> 25 lbs.				<b>COM:</b> 1.5 yds. <b>COL:</b> 27 sq.ft.					
		COM	COL	1	2	3	4	5	6	7	8	9	10	L1	L2
		858	944	868	896	924	952	980	1008	1036	1064	1092	1120	1170	1271
		<i>5 Star Nylon Base w/ Casters / Non-Tilting Control / Pneumatic Seat Height Adjustment</i>													

LEGS / CASTERS / LOCK / TOPS	OPTION #:	SPECIFICATIONS   LIST PRICES   AVAILABILITY:
<b>METAL LEGS</b>		
		<b>Overall:</b> 2"dia 4"h
 <p>MLN</p>  <p>MLB</p>	<p><b>MLN</b> \$153 (Set Of 4) <i>Nickel Metal Legs</i></p> <p><b>MLB</b> \$153 (Set Of 4) <i>Matte Black Metal Legs</i></p> <p><b>Available:</b> Serene Chests &amp; Bedside Cabinets</p>	
	<b>CASTERS</b>	
		<b>Overall:</b> 3"dia 2"w 4"h
 <p>CAS-NL</p>  <p>CAS-L</p>	<p><b>CAS-NL</b> \$305 (Set Of 2) <i>Non-Locking Swivel Gray &amp; Silver Plastic Casters</i></p> <p><b>CAS-L</b> \$305 (Set Of 2) <i>Locking Swivel Gray &amp; Silver Plastic Casters</i></p> <p><b>Available:</b> Serene Bedside Cabinets</p>	
	<b>DRAWER / DOOR LOCK</b>	
		<b>Overall:</b> 7/8" dia
	<b>DOL</b>	<p>\$127 (Per Lock) <i>Black Metal Drawer / Door Lock</i></p> <p><b>Available:</b> Serene 61-232, 61-801, 61-803</p>
<b>THERMOFOIL DRIP PROOF TOP</b>		
		<b>Overall:</b> Per Top Size
	<b>TDPT-1</b>	<p>CALL FOR PRICING (Top For Chest) <i>TFL Thermofoil Drip Proof Top - Specify Color</i></p>
	<b>TDPT-2</b>	<p>CALL FOR PRICING (Top For Bedside Cabinet) <i>TFL Thermofoil Drip Proof Top - Specify Color</i></p>
	<b>TDPT-3</b>	<p>CALL FOR PRICING (Top For Over-The-Bed Table) <i>TFL Thermofoil Drip Proof Top - Specify Color</i></p> <p><b>Available:</b> Serene Chests, Bedside Cabinets &amp; Over-The-Bed Table</p>

TOPS / DRAWER LINERS	OPTION #:	SPECIFICATIONS   LIST PRICES   AVAILABILITY:
<p><b>SOLID SURFACE DRIP PROOF TOP</b></p> 	<p><i>Overall: Per Top Size</i></p> <hr/> <p><b>SDPT-1</b> CALL FOR PRICING (Top For Chest) <i>Solid Surface Drip Proof Top - Standard In White (Additional Colors Available)</i></p> <p><b>SDPT-2</b> CALL FOR PRICING (Top For Bedside Cabinet) <i>Solid Surface Drip Proof Top - Standard In White (Additional Colors Available)</i></p> <p><b>SDPT-3</b> CALL FOR PRICING (Top For Over-The-Bed Table) <i>Solid Surface Drip Proof Top - Standard In White (Additional Colors Available)</i></p> <p><i>Available: Serene Chests, Bedside Cabinets &amp; Over-The-Bed Table</i></p>	
<p><b>REMOVABLE PLASTIC DRAWER LINERS</b></p>	<p><i>Overall: Per Drawer Size</i></p> <hr/> <p><b>RDL-1</b> CALL FOR PRICING (1 Liner Per Drawer - Chest) <i>Removable Plastic Drawer Liner - Black Color</i></p> <p><b>RDL-2</b> \$133 (1 Liner Per Drawer - Bedside Cabinet) <i>Removable Plastic Drawer Liner - Black Color</i></p> <p><b>RDL-3</b> CALL FOR PRICING (1 Liner Per Drawer - Full Wardrobe) <i>Removable Plastic Drawer Liner - Black Color</i></p> <p><i>Available: Serene Chests, Bedside Cabinets &amp; Full Wardrobe</i></p>	