

T R I N I T Y

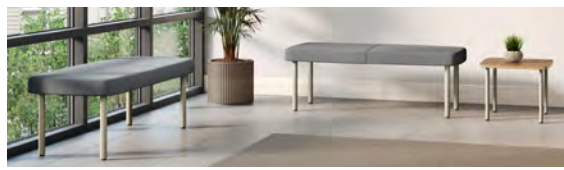
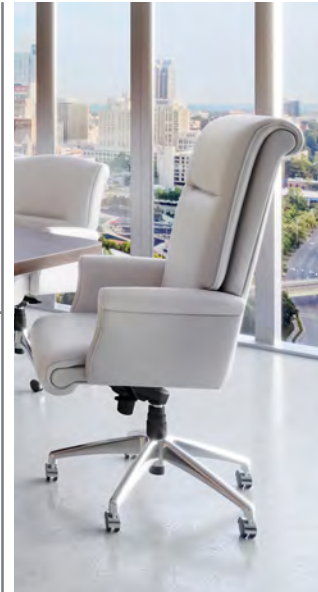

PRICE LIST
2025

MARCH 1, 2025

SEATING & TABLES

Workplace | Education | Government | Healthcare

Date:

Page:

Modification:

Description:

| | |
|---|---------|
| Table Of Contents..... | 1 |
| Conditions Of Sale..... | 2 |
| General Information..... | 3 |
| Order Information..... | 4-9 |
| GSA Multiple Award Contract Guidelines..... | 10 |
| | |
| Radcliffe Square (<i>Item #: 251 - 299; 2516D18 - 254818</i>)..... | 11-23 |
| Cilo ² (<i>Item #: 307 - 312</i>)..... | 24-30 |
| Ziggy (<i>Item #: 330-A - 331-E</i>)..... | 31-34 |
| Vroom (<i>Item #: 332-B - 332-D; 324D22-B-L - 3303017-D-L</i>)..... | 35-42 |
| Swerve (<i>Item #: 341-A - 341-D</i>)..... | 43-49 |
| Wingding (<i>Item #: 344-A - 346-B</i>)..... | 50-54 |
| Crest (<i>Item #: 347-A - 347-D</i>)..... | 55-59 |
| Steel (<i>Item #: 350 - 365</i>)..... | 60-67 |
| Edge (<i>Item #: 371 - 385; 322D23 - 336D16</i>)..... | 68-74 |
| Traditional (<i>Item #: 400 - 495</i>)..... | 75-91 |
| Conrad (<i>Item #: 500 - 577</i>)..... | 92-104 |
| Classic (<i>Item #: 700 - 796; 7020 - 7048</i>)..... | 105-118 |
| Langton (<i>Item #: 811 - 826</i>)..... | 119-125 |
| Luci Guci (<i>Item #: 831 - 859</i>)..... | 126-135 |
| Quads (<i>Item #: 861 - 896</i>)..... | 136-148 |
| Savoie (<i>Item #: 1001 - 1048; 102020 - 102242</i>)..... | 149-161 |
| Ace (<i>Item #: 1055-A - 1055-D; 1056-A - 1056-D</i>)..... | 162-166 |
| Austen Lounge & Benches (<i>Item #: 1922 - 1951; 19C1022-L - 194220-L</i>)..... | 167-172 |
| Austen Guest-Tandem-Tables (<i>Item #: 1922 - 1951; 19C1022-L - 194220-L</i>)..... | 173-186 |
| Serene (<i>Item #: 61-128 - 61-803; 61-4828; 61-1619 - 61-2419</i>)..... | 187-196 |
| Jewel (<i>Item #: M101 - M110</i>)..... | 197-201 |
| | |
| Facelift General Information..... | 202-203 |
| Facelift Replay (<i>Item #: 1501 - 1535</i>)..... | 204-212 |
| Facelift Replay Healthcare Motion (<i>Item #: 1504 - 1513</i>)..... | 213-225 |
| Facelift Polliwogs (<i>Item #: 1540-I/O - 1545-30T</i>)..... | 226-232 |
| Facelift Fair & Square (<i>Item #: 1550 - 1564</i>)..... | 233-240 |
| Facelift Serpentine (<i>Item #: 1571 - 1595; 152230 - 15180DG16</i>)..... | 241-255 |
| Facelift Tuxedo (<i>Item #: 1603</i>)..... | 256-259 |
| Facelift Prime Lounge (<i>Item #: 1701 - 1713</i>)..... | 260-266 |
| Facelift Prime Guest / Tandem / Benches / Tables (<i>Item #: 1720 - 1773; 1716D23 - 1722DC</i>)..... | 267-276 |
| Facelift Revival Lounge / Benches (<i>Item #: 1801 - 1819</i>)..... | 277-281 |
| Facelift Revival Healthcare Motion (<i>Item #: 1804 - 1813</i>)..... | 282-292 |
| Facelift Evolve Guest / Tandem / Tables (<i>Item #: 1820 - 1851; 18C2020 - 1834D16</i>)..... | 293-315 |
| Facelift Evolve Healthcare Motion (<i>Item #: 1820-H - 1857</i>)..... | 316-329 |
| Facelift Evolve Healthcare Motion (Weight-Activated Medical Recliners) (<i>Item #: 1858 - 1868-XE</i>)..... | 330-337 |
| Facelift Evolve Lounge / Tandem (<i>Item #: 1841 - 1874</i>)..... | 338-350 |
| Facelift Evolve Fully Upholstered Guest / Tandem (<i>Item #: 1880 - 1885</i>)..... | 351-359 |

PRICES

ALL PRICES ARE LIST, F.O.B. ORIGIN AT OUR PLANT IN TRINITY, NC. WE HAVE THE RIGHT TO CHANGE PRICES AND SPECIFICATIONS WITHOUT NOTICE. PRICES INCLUDE COMPLETE BOXING.

TERMS

TERMS ARE NET 30 FOR OPEN ACCOUNTS. AFTER 30 DAYS, A 1.5% PER MONTH OVERDUE SURCHARGE IS ADDED AND STRICTLY ENFORCED. NORMAL COLLECTION COSTS AND ATTORNEY'S FEES WILL BE THE RESPONSIBILITY OF DELINQUENT ACCOUNTS.

CREDIT

TRINITY FURNITURE, PO BOX 150, TRINITY, NC 27370 336-472-6660

CUSTOMERS WITH A SATISFACTORY CREDIT RATING WITH A RECOGNIZED CREDIT AGENCY MAY OPEN AN ACCOUNT. CUSTOMERS WITHOUT SUCH RATING MAY SUBMIT BANK AND TRADE REFERENCES TO OUR FACTORY FOR CREDIT APPROVAL. PLEASE ALLOW EXTRA TIME FOR CREDIT PROCESSING. FOR THOSE WITHOUT SATISFACTORY CREDIT WANTING TO ESTABLISH AN ACCOUNT, TRINITY FURNITURE WILL PROCESS ORDERS WITH RECEIPT OF A 50% DEPOSIT, WITH THE BALANCE REQUIRED BEFORE SHIPMENT.

ORDERS

ORDERS ARE NOT CONSIDERED ACCEPTED UNTIL OUR RESPONSE WITH AN ACKNOWLEDGEMENT. PLEASE CHECK ALL FACTORY ACKNOWLEDGEMENTS TO CONFIRM YOUR ORIGINAL ORDER. ONCE AN ORDER IS ACKNOWLEDGED TO YOU, THE FACTORY WILL BE RESPONSIBLE FOR SHIPPING EXACTLY THE ITEMS AT THE PRICES ACKNOWLEDGED. CHANGES REQUESTED ON ACKNOWLEDGED ORDERS WILL BE CONSIDERED AND MADE ONLY IF POSSIBLE. NO ADJUSTMENTS CAN BE MADE TO AN ORDER ONCE IT IS PLACED INTO PRODUCTION WITHOUT PENALTY, SEE "CANCELLATIONS" BELOW. WE DO NOT ACKNOWLEDGE AN ORDER WITH SHIP DATE, UNTIL IT IS A COMPLETE ORDER, AND ABLE TO BE PUT INTO PRODUCTION.

CANCELLATIONS

CANCELLATIONS CANNOT BE ACCEPTED AFTER ORDERS ARE IN THE PROCESS OF PRODUCTION AND THE ORDER MUST BE SHIPPED UPON COMPLETION. IF YOU INSIST UPON A CANCELLATION, WE WILL BILL YOU FOR THE PORTION OF THE WORK THAT HAS BEEN DONE ON THE ORDER PLUS A 25% RESTOCKING/ADMINISTRATION CHARGE

STORAGE

IF A CUSTOMER IS UNABLE TO RECEIVE, OR IN THE CASE OF C.B.D. ORDERS FOR WHICH PAYMENT HAS NOT BEEN RECEIVED, FURNITURE WILL BE INVOICED AND WAREHOUSING / STORAGE CHARGES WILL BE INCURRED. ALL OTHER COSTS ASSOCIATED WITH STORAGE, INCLUDING TRANSPORTATION AND LABOR, WILL BE CHARGED TO THE CUSTOMER. THE CUSTOMER WILL BEAR ALL THE RISKS OF DAMAGE OR LOSS DURING STORAGE OF THE MERCHANDISE.

SHIPPING

TRINITY WILL SHIP IN ACCORDANCE WITH THE CUSTOMER INSTRUCTIONS WHENEVER POSSIBLE. WE WILL EXERCISE OUR BEST JUDGEMENT IN SELECTING AN APPROPRIATE CARRIER WHENEVER ONE HAS NOT BEEN SPECIFIED BY THE CUSTOMER. A GUARANTEED FREIGHT PROGRAM IS AVAILABLE AND DESCRIBED ON PAGE 3.

DAMAGES / CLAIMS

TRINITY IS NOT RESPONSIBLE FOR DAMAGE IN TRANSIT OR STORAGE. THE CONSIGNEE MUST INSPECT THE MERCHANDISE UPON RECEIPT AND NOTE ANY OBVIOUS DAMAGE ON CARRIER'S DELIVERY RECEIPT. DAMAGE WHICH BECOMES APPARENT WHEN THE MERCHANDISE IS UNPACKED, "CONCEALED DAMAGE," SHOULD BE REPORTED TO TRINITY WITHIN TWO (2) DAYS OF RECEIPT OF GOODS. FAILURE TO MAKE SUCH CLAIMS SHALL CONSTITUTE FULL ACCEPTANCE OF THE MERCHANDISE. NO CREDIT, REPAIRS OR ALLOWANCES WILL BE APPROVED WITHOUT OUR WRITTEN AUTHORITY TO DO SO.

VISIBLE OR CONCEALED DAMAGE PROTOCOL:

1. OPEN ALL CARTONS IN DRIVER'S PRESENCE.
2. IF DAMAGE IS APPARENT, TAKE DIGITAL PICTURES OF CARTON AND FURNITURE UPON DELIVERY TO DOCK.
3. NOTE ANY DAMAGE TO THE GOODS ON THE CARRIER'S FREIGHT BILL AS NUMBER OF PIECES DAMAGED.
4. DO NOT THROW PACKAGING AWAY OR MOVE THE FURNITURE TO A DIFFERENT LOCATION.
5. DAMAGE CLAIMS DO NOT COVER DELIVERY TO NON-DOCK LOCATIONS, CLAIMS MADE AFTER THE FURNITURE HAS BEEN INSTALLED AND/ OR REMOVED FROM THE ORIGINAL DELIVERY LOCATION OR CARTON AND PACKAGING HAS BEEN REMOVED.
6. IF DAMAGE IS APPARENT AFTER THE ALLOTTED TIME, COST OF THE REPAIR OR REPLACEMENT WILL NOT BE TRINITY'S RESPONSIBILITY.

CONSTRUCTION

OUR FURNITURE IS DESIGNED, ENGINEERED AND MANUFACTURED TO ACCEPT THE USE OF HIGH DENSITY PUBLIC INSTALLATIONS. WOOD FRAMES ARE CONSTRUCTED OF ONLY KILN DRIED SELECT HARDWOODS AND REINFORCED PLYWOOD MEMBERS WHICH UTILIZE DOUBLE DOWEL AND CORNER BLOCK JOINERY. SPRINGING SYSTEMS HAVE BEEN INDIVIDUALLY DESIGNED FOR EACH FURNITURE STYLE AND REPRESENT THE LATEST IN INDUSTRY TECHNOLOGY OF SHEET WEBBING, SINUOUS WIRE, OR HAND-TIED COILED SPRING CONSTRUCTION. EXPOSED WOOD FINISHED FRAME PARTS ARE SPRAYED WITH SAFE-T-GUARD® CATALYZED ACRYLIC LACQUER NOTED FOR ITS ANTIMICROBIAL FACTOR AND RESISTANCE TO NORMAL WEAR AND ITS ABILITY TO BE REFINISHED IF DAMAGED. GENERALLY, SOLID CHERRY OR MAPLE IS USED FOR ALL EXPOSED WOOD COMPONENTS. REFER TO SPECIFICATIONS FOR ANY EXCEPTIONS. **OUR FRAMES GO THROUGH OUR ON SITE TESTING LAB VERIFYING GSA HEAVY DUTY RATINGS.** EXACT CONSTRUCTION SPECIFICATIONS ARE AVAILABLE UPON REQUEST.

NOTICE:

1. THE FOLLOWING GUEST / SIDE CHAIRS ARE STANDARD WITH WALLSAVER LEGS: EDGE, EVOLVE, REPLAY, STEEL, AND ZEE
2. ALL SEATING AND TABLES ARE STANDARD WITH NAIL-IN OR ADJUSTABLE GLIDES.
3. ALL SEATING IS RATED FOR 350 LBS. UNLESS THEY ARE BARIATRIC, IN WHICH THEY WILL HAVE A MINIMUM OF 500 LB. TO 1000 LB. RATING.

FLAMMABILITY

UNLESS OTHERWISE SPECIFIED, FOAM USED IN ALL TRINITY FURNITURE INCORPORATED SEATING PRODUCTS COMPLIES WITH CALIFORNIA TECHNICAL BULLETIN 117-2013. PLEASE CONTACT CUSTOMER SUPPORT FOR PRICING IF COMPLIANCE OR CERTIFICATION IS REQUIRED FOR THE OTHER FIRE CODES. INCLUDING:

BOSTON FIRE CODE**CALIFORNIA TECHNICAL BULLETIN 133****NEW YORK PORT AUTHORITY****SPECIFICATIONS**

ALL ITEMS ARE PRODUCED TO PRICE LIST SPECIFICATIONS. WE RESERVE THE RIGHT TO MAKE MODIFICATIONS AND IMPROVEMENTS WITHOUT PRIOR NOTICE. ALL DIMENSIONS SHOWN ARE APPROXIMATE AND MAY VARY DUE TO COVER BEING USED.

WARRANTY

TRINITY FURNITURE INCORPORATED WARRANTS ALL NON-FACELIFT PRODUCTS FOR TEN (10) YEARS AGAINST MANUFACTURING AND FACTORY DEFECTS, EXCLUDING COVERING MATERIALS, UNDER NORMAL SINGLE SHIFT SERVICE FOR ORIGINAL PURCHASER. DURING THIS PERIOD TRINITY FURNITURE, AT OUR OPTION, WILL REPLACE, REPAIR, OR RETURN THE PURCHASE PRICE OF ANY MERCHANDISE THAT, UPON OUR INSPECTION, IS DEEMED TO BE DEFECTIVE. THIS CONSTITUTES THE SOLE AND EXCLUSIVE REMEDY TO THE CUSTOMER. DAMAGES RESULTING FROM FREIGHT, CLAIMED OR UNCLAIMED, FROM ACCIDENT, ALTERATION, TAMPERING, MISUSE, NEGLIGENCE OR ABUSE VOIDS THIS WARRANTY. IN THE EVENT ANY PRODUCT HAS TO BE RETURNED TO THE FACTORY FOR VERIFICATION OF A COMPLAINT, IT MUST BE SHIPPED PREPAID AND INCLUDE WRITTEN INFORMATION CONTAINING THE NAME OF THE ORIGINAL PURCHASER, ORIGINAL INVOICE NUMBER, AND A COPY OF THE ORIGINAL PURCHASE ORDER MUST BE PROVIDED. BECAUSE OF NATURAL VARIATIONS ON MATERIALS OVER WHICH TRINITY FURNITURE INC. HAS NO CONTROL. THIS WARRANTY DOES NOT EXTEND TO COLOR, GRAIN OR TEXTURE OF WOOD, LEATHER OR UPHOLSTERY COVER. THIS WARRANTY IS APPLICABLE ONLY TO THOSE PARTS ACTUALLY MANUFACTURED BY TRINITY FURNITURE INCORPORATED. FOR PURCHASED COMPONENT PARTS, WE WILL APPLY EXACTLY THE SAME WARRANTY THAT IS EXTENDED TO US BY OUR SUPPLIER. TRINITY FURNITURE INCORPORATED SHALL NOT BE LIABLE FOR CONSEQUENTIAL OR INCIDENTAL DAMAGES ARISING FROM ANY PRODUCT DEFECT.

MADE IN AMERICA

ALL FURNITURE IS PROUDLY MADE IN THE UNITED STATES OF AMERICA.

ENVIRONMENTAL SUSTAINABILITY**ALL TRINITY FURNITURE PRODUCTS HAVE LEVEL 1 CERTIFICATION**

THE BUSINESS INSTITUTIONAL FURNITURE MANUFACTURERS ASSOCIATES (BIFMA) LEVEL STANDARD IS TO PROVIDE MEASURABLE MARKET-BASED DEFINITIONS OF PROGRESSIVELY MORE SUSTAINABLE FURNITURE BY ESTABLISHING PERFORMANCE CRITERIA THAT ADDRESS ENVIRONMENTAL AND SOCIAL ASPECTS THROUGHOUT THE SUPPLY CHAIN.

THIS STANDARD PROVIDES A PATHWAY TOWARDS SUSTAINABILITY BY ESTABLISHING MEASURABLE CRITERIA FOR MULTIPLE LEVELS OF ACHIEVEMENT AND/OR PERFORMANCE. IT ADDRESSES PRODUCT BASED CHARACTERISTICS IN THE GENERAL AREA OF MATERIALS, USE OF ENERGY, HUMAN AND ECOSYSTEM HEALTH, AND SOCIAL RESPONSIBILITY IMPACTS.

TRINITY FURNITURE IS PROUD TO PARTNER WITH USGBC IN IMPLEMENTING THE LEED PROGRAM INTO OUR MANUFACTURING PROCESS TO PROMOTE SUSTAINABLE FORESTRY AND TO PROTECT THE RESOURCES THAT OUR BUSINESS AND ENVIRONMENT DEPENDS ON FOR EXISTENCE.



ORDERS

ORDERS MUST BE CONFIRMED IN WRITING, EITHER BY MAIL, E-MAIL OR FAX, TO OUR CORPORATE HEADQUARTERS:

TRINITY FURNITURE INCORPORATED

ATTN: ORDER ENTRY

6089 KENNEDY ROAD

P.O. BOX 150

TRINITY, NC 27370

336-472-6660 - TOLL FREE 855-311-6660

336-475-0037, FAX

sales@trinityfurniture.com

FREIGHT PROGRAM

ORDERS MUST BE CONFIRMED IN WRITING, EITHER BY MAIL, E-MAIL OR FAX, TO OUR CORPORATE HEADQUARTERS:

TRINITY FURNITURE INCORPORATED

ATTN: ORDER ENTRY

6089 KENNEDY ROAD

P.O. BOX 150

TRINITY, NC 27370

336-472-6660 - TOLL FREE 855-311-6660

336-475-0037, FAX

sales@trinityfurniture.com

PLEASE CONTACT TRINITY CUSTOMER SERVICE FOR ALL FREIGHT QUOTES.

EXTRA CHARGES ARE AS FOLLOWS:

1. A NEED FOR SPECIAL DELIVERY EQUIPMENT, INCLUDING LIFT GATES.
2. INSIDE DELIVERY.
3. THE ABSENCE OF A LOADING DOCK.
4. REDIRECTION OR RECONSIGNMENT OF PRODUCT.
5. DETENTION CHARGES.
6. STREET UNLOADS.
7. IMPROPER REFUSAL OF PRODUCT.
8. CALL BEFORE DELIVER, APPOINTMENT.

WOOD FINISHES

ALL STANDARD WOOD FINISHES ARE ON SELECTED HARDWOOD. ALL WOOD SAMPLES ARE ON CHERRY WOOD. SAFE-T-GUARD® ANTIMICROBIAL ADDITIVE FINISH IS THE STANDARD TOP COAT.

| | |
|--------------------------------|------------------------------------|
| FINISH: CLEAR MAPLE | FINISH: FUSION MAPLE |
| LAMINATE: WILSONART | LAMINATE: WILSONART |
| FINISH: BILTMORE CHERRY | FINISH: WILLIAMSBURG CHERRY |
| LAMINATE: WILSONART | LAMINATE: WILSONART |
| FINISH: SKYLINE WALNUT | FINISH: PINNACLE WALNUT |
| LAMINATE: WILSONART | LAMINATE: WILSONART |
| FINISH: HAMPTON WALNUT | FINISH: COCOBALA WALNUT |
| LAMINATE: WILSONART | LAMINATE: WILSONART |
| FINISH: EMPIRE MAHOGANY | FINISH: EBONY |
| LAMINATE: WILSONART | LAMINATE: WILSONART |

CUSTOM WOOD FINISHES ARE AVAILABLE.

NOTE: ENTIRE FRAME AND SEAT STRUCTURE CAN BE BLEACH SOLUTION AND HEALTHCARE GRADE GERMICIDE CLEANABLE. PLEASE CONTACT TRINITY FOR LIST OF APPROVED CLEANERS.

CUSTOM WOOD FINISH

NOTE: Any custom finish match will incur a \$300 NET upcharge. This is a one-time charge per order.

- Actual finish sample must be sent in with purchase order for matching.
- Darran will be the only vendor that we will match to with NO upcharge.
- Custom matches will be waived on orders over \$50,000 NET
- Custom finish upcharge for repeat or additional orders will be \$150 NET per order, even when the upcharge was waived on the original project.
- Custom finish matches are valid for 12 months from sample date. After this time period, custom finishes must be rematched and reapproved for use, and a new sample must be sent to the factory.

The disclaimer for duplicating custom finishes will remain the same as below and this will be updated in the price list online. TRINITY WILL MAKE EVERY ATTEMPT TO DUPLICATE YOUR FINISH, BUT BECAUSE OF THE NATURAL AND VARIED CHARACTERISTICS OF WOOD, SLIGHT VARIATIONS WILL OCCUR. IF A STRIKE-OFF IS REQUESTED, THE ORDER WILL BE HELD FROM PRODUCTION UNTIL THE CUSTOM/SPECIAL FINISH APPROVAL HAS BEEN RECEIVED IN WRITING AT THE FACTORY. AT THAT TIME, YOU WILL BE NOTIFIED OF THE SHIP/PRODUCTION DATE.

GENERAL UPHOLSTERY INFORMATION

SEAMING WE RESERVE THE RIGHT TO SEAM PATTERNS IF NECESSARY. OUR UPHOLSTERY PATTERNS ARE BASED ON RAILROADED FABRIC. IF UPHOLSTERY, EITHER TRINITY FABRIC OR COM, IS TO BE APPLIED 'UP THE GOODS', SEAMS MAY BE REQUIRED. IF USING TRINITY LEATHER OR COL, SOME LARGER PATTERN PIECES MAY NEED TO BE SEAMED.

| PILLOWS | | <i>Overall: 18"w 5"d 18"h</i> | | <i>COM: 1 yd.</i> | | <i>COL: 18 sq.ft.</i> | | | | | | | | | |
|---|---------------|-------------------------------|-----|-------------------|-----|-----------------------|-----|-----|-----|-----|-----|-----|-----|-----|-----|
| | | <i>Overall: 22"w 5"d 12"h</i> | | <i>COM: 1 yd.</i> | | <i>COL: 18 sq.ft.</i> | | | | | | | | | |
| | | COM | COL | 1 | 2 | 3 | 4 | 5 | 6 | 7 | 8 | 9 | 10 | L1 | L2 |
| 18" X 18" PILLOW | TP1818 | 120 | 129 | 174 | 201 | 228 | 255 | 281 | 309 | 336 | 363 | 389 | 416 | 444 | 537 |
| <i>Feather Down Fill / Down Proof Ticking / Welting Around Parimeter Of Cushion</i> | | | | | | | | | | | | | | | |
| 12" X 22" PILLOW | TP1222 | 76 | 85 | 131 | 157 | 184 | 211 | 239 | 265 | 292 | 319 | 346 | 372 | 401 | 497 |
| <i>Polyester Fill Only / Welting Around Parimeter Of Cushion</i> | | | | | | | | | | | | | | | |

NOTE: Textile options available from moisture resistant fabric to vinyl, including COM/Healthcare grade fabric and cleanable using germicide or bleach solution.

Standard Wood Finishes And Matching Wilsonart Laminates



Finish: Clear Maple
Matching Laminate: Wilsonart



Finish: Fusion Maple
Matching Laminate: Wilsonart



Finish: Biltmore Cherry
Matching Laminate: Wilsonart



Finish: Williamsburg Cherry
Matching Laminate: Wilsonart

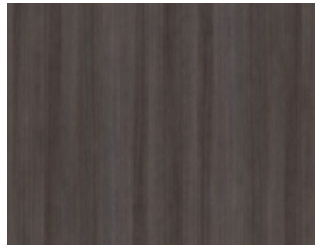

Finish: Skyline Walnut
Matching Laminate: Wilsonart

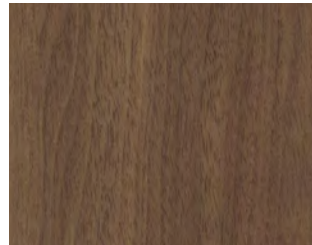

Finish: Pinnacle Walnut
Matching Laminate: Wilsonart



Finish: Hampton Walnut
Matching Laminate: Wilsonart

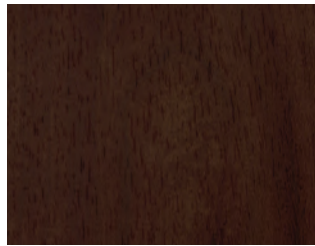

Finish: Cocobala Walnut
Matching Laminate: Wilsonart

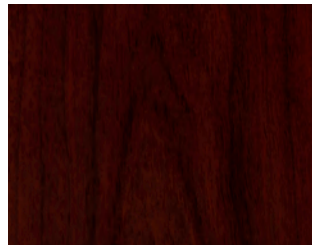

Finish: Empire Mahogany
Matching Laminate: Wilsonart



Finish: Ebony
Matching Laminate: Wilsonart



Laminate: White Nebula
Wilsonart

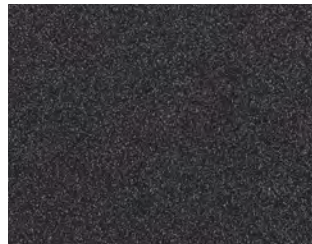

Laminate: Graphite Nebula
Wilsonart

NOTE: Any custom finish match will incur a \$300 NET upcharge. This is a one-time charge per order.

- Actual finish sample must be sent in with purchase order for matching.
- Darran will be the only vendor that we will match to with NO upcharge.
- Custom matches will be waived on orders over \$50,000 NET
- Custom finish upcharge for repeat or additional orders will be \$150 NET per order, even when the upcharge was waived on the original project.
- Custom finish matches are valid for 12 months from sample date. After this time period, custom finishes must be rematched and reapproved for use, and a new sample must be sent to the factory.

The disclaimer for duplicating custom finishes will remain the same as below and this will be updated in the price list online.

TRINITY WILL MAKE EVERY ATTEMPT TO DUPLICATE YOUR FINISH, BUT BECAUSE OF THE NATURAL AND VARIED CHARACTERISTICS OF WOOD, SLIGHT VARIATIONS WILL OCCUR. IF A STRIKE-OFF IS REQUESTED, THE ORDER WILL BE HELD FROM PRODUCTION UNTIL THE CUSTOM/SPECIAL FINISH APPROVAL HAS BEEN RECEIVED IN WRITING AT THE FACTORY. AT THAT TIME, YOU WILL BE NOTIFIED OF THE SHIP/PRODUCTION DATE.

Due to variations in screen displays, finishes shown here may not match actual finishes exactly. These samples are a digital representation and are as accurate as technology will allow.

Wood color and grain characteristics will vary and exact matches are impossible.

These images are for color reference only. If you require an actual wood sample, please contact your representative or contact the factory.

NOTE

When ordering a light to clear finish, the natural characteristics and variations in the grain of the wood will be more apparent. When ordering a dark or medium finish the natural characteristics and variations in the grain of the wood will be more subdued, providing a more uniform appearance. All colors shown are on solid cherry or maple, which are generally the standard wood species used for Trinity Furniture models. Certain models may use a different grain characteristics. Please review the product specifications of each furniture item to be certain of the wood type used and available finishes. Special finish matches are also available. A finish sample is required and must be submitted to Trinity with the order.

Note: Trinity will match finishes from DARRAN at no charge.

ANTIMICROBIAL PROPERTIES

All wood finishes are specially formulated with Safe-T-Guard antimicrobial additive to prevent the growth or expansion of mold, mildew, fungus, or bacteria on exposed wood surfaces.

TABLES AVAILABLE WITH LAMINATE OR VENEER

Laminate Pairings are available for most wood finishes. Additional laminates are available.

Please contact customer service for more information.

Molded polyester resin arm caps are finished with a durable catalyzed acrylic polyurethane top coat yielding them highly resistant to hospital cleaners. A broad range of colors are available.

POLYESTER ARM COLORS
(Durable Acrylic Polyurethane Finish)



53 Aqua



91 Ash



14 Bisque



99 Black



85 Blue

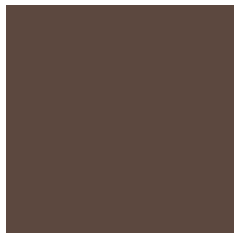

48 Brown



25 Burgundy



33 Camel



54 Cerulean



28 Cordovan



11 Cream



59 Deep Green



95 Grey



57 Hunter Green



10 Latte



75 Light Teal

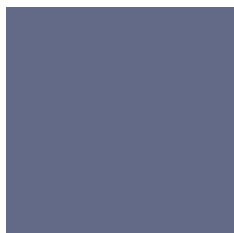

22 Lilac



89 Navy



88 Ocean



34 Paprika



44 Pebble

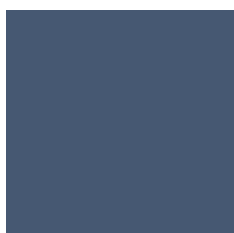

83 Periwinkle

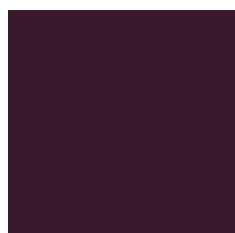

27 Purple



13 Toast

COM / COL INFORMATION

CUSTOMERS OWN MATERIAL (COM) / CUSTOMERS OWN LEATHER (COL)

FABRIC, VINYL AND FAUX LEATHER, OR IF IT IS PURCHASED BY THE YARD, THEN USE THE COM COLUMN. IF IT IS PURCHASED BY THE SQUARE FOOT, THEN USE THE COL COLUMN.

GENERAL FURNITURE ORDERS MUST INCLUDE:

- 1- DESCRIPTION OF THE FABRIC(S) OR LEATHER(S),
- 2- SOURCE OF FABRIC(S) OR LEATHER(S)
- 3- PATTERN NUMBER AND COLOR
- 4- SWATCH OF THE FABRIC(S) OR LEATHER(S)

COM - ALL YARDAGE REQUIREMENTS ARE BASED ON 54" PLAIN NON-DIRECTIONAL MATERIAL.

VELVET OR NAPPED FABRICS WILL REQUIRE AN ADDITIONAL 15% OF OUR STANDARD COM YARDAGE REQUIREMENT.

COL - SQUARE FOOTAGE REQUIREMENTS ARE BASED ON LEATHER HIDES WHICH AVERAGE 45-50 SQ. FT.

APPLICATION ALL COM FABRICS WILL BE APPLIED AT FACTORY'S DISCRETION, (**ALL STRIPES WILL BE APPLIED VERTICAL**) UNLESS THE CUSTOMER SPECIFIES PATTERN AND FACE DIRECTION TO BE APPLIED, WITH SAMPLE ON THE PURCHASE ORDER. WE RESERVE THE RIGHT TO REJECT ANY MATERIAL THAT WE DEEM UNACCEPTABLE FOR UPHOLSTERY. UNDER NO CIRCUMSTANCES SHALL WE BE HELD RESPONSIBLE FOR UNSATISFACTORY RESULTS DUE TO USE OF MATERIAL UNSUITABLE FOR OUR MANUFACTURING METHODS. **TRINITY MUST APPROVE SPECIFIC FABRICS & LEATHERS USED FOR TUFTING. UPHOLSTERY PATTERNS ARE BASED ON RAILROADED FABRIC. IF COM IS TO BE APPLIED "UP THE GOODS", ADDITIONAL YARDAGE MAY BE REQUIRED. TUFTING AND STITCHED UNITS NEED PRE APPROVAL FOR STRIPED OR PATTERNED UPHOLSTERY.** CONTACT CUSTOMER SERVICE FOR SPECIFIC REQUIREMENTS.

INSPECTION COM – ALL COM IS INSPECTED UPON RECEIPT, FOR FLAWS, AND YARDAGE RECEIVED. WE DO NOT INSPECT YARDAGE RECEIVED FOR REPEATS OR PATTERN PLACEMENT UNTIL THE CUTTING PROCESS.

COL – ALL COL IS VERIFIED AT TIME OF RECEIPT, FOR FOOTAGE RECEIVED. DUE TO THE NATURE OF SOME COL, TRINITY FURNITURE DOES NOT INSPECT COL AT TIME OF RECEIPT FOR FLAWS, OR DEFECTS. THIS INSPECTION IS MADE DURING THE CUTTING PROCESS. TRINITY FURNITURE WILL NOT ASSUME RESPONSIBILITY FOR IMPERFECTIONS, INCLUDING RANGE MARKS, IN THE LEATHER, DYE-LOT VARIATIONS, OR WEARING QUALITIES.

PRICING USE THE COM OR COL PRICING LISTED UNDER EACH STYLE.

ESTIMATED ADDITIONAL REQUIREMENTS BASED ON PATTERN REPEAT.

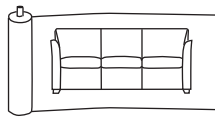

RAILROAD

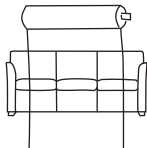

UP THE GOODS

| WIDTH | REPEAT | RAILROAD 1-WAY REPEAT | UP THE GOODS 1-WAY REPEAT | NAP OR SUEDE |
|--------|--------------|-----------------------------|---------------------------------|--------------------|
| 54" | LESS THAN 2" | 0% | 15% | 15% |
| | 2-10" | 10% | 20% | |
| | 11-19" | 15% | 25% | |
| | 20-25" | 20% | 30% | |
| | 26-30" | 25% | 35% | |
| 51-53" | LESS THAN 2" | 10% | 20% | 25% |
| | 2-10" | 20% | 30% | |
| | 11-19" | 25% | 35% | |
| | 20-25" | 30% | 40% | |
| | 26-30" | 35% | 45% | |

ACTUAL QUANTITY MAY VARY DUE TO THE DIFFERENCE OF THE INDIVIDUAL FURNITURE STYLE, YOUR UPHOLSTERY SELECTION, AND ITS CUTTING REQUIREMENT.

THE LINK BELOW PROVIDES MORE INFORMATION CONCERNING UPHOLSTERY OPTIONS:

www.trinityfurniture.com/fabricsleather

RETURN EXCESS

UNUSED COM OR COL WILL BE RETURNED ONLY WHEN REQUESTED IN WRITING. THERE IS A MINIMUM \$15 HANDLING CHARGE PLUS ANY APPLICATION SHIPPING CHARGE.

SHIP DATE

ALL ORDERS ARE HELD FROM PRODUCTION UNTIL ALL THE COM/COL HAS ARRIVED AT THE FACTORY, UNLESS WRITTEN AUTHORIZATION FOR BACK ORDER IS GIVEN. AT THAT TIME, YOU WILL BE NOTIFIED OF THE SHIP/PRODUCTION DATE.

SHIP TO ADDRESS

COM / COL MUST BE SHIPPED PREPAID TO FACTORY AT:

TRINITY FURNITURE INCORPORATED

TAG: YOUR COMPANY NAME AND PURCHASE ORDER NUMBER

6089 KENNEDY ROAD

TRINITY, NC 27370

TRINITY TEXTILE INFORMATION

ALL OF OUR CARDED TEXTILES PASS CALIFORNIA CODE 117 FLAME RESISTANCE REQUIREMENTS. ALL UPHOLSTERY COVERS SHOWN IN OUR BINDER OR SPECIFIED VIA ONE OF OUR UPHOLSTERY CARDS, CAN BE PURCHASED BY THE YARD. F.O.B. FACTORY, TRINITY, NC. FOR FIBER CONTENT, SEE SWATCH CARD. MINIMUM ORDER FOR FABRIC IS "1" YARD, THEN ¼ YARD INCREMENTS. MINIMUM ORDER FOR LEATHER IS ONE HALF HIDE, APPROXIMATELY 25 SQ. FT. WE WILL MAKE EVERY EFFORT TO SUPPLY YOU WITH THE EXACT SQUARE FOOTAGE ORDERED, BUT IF WE ARE UNABLE TO, YOU WILL BE INVOICED FOR SQUARE FOOTAGE OF LEATHER SHIPPED.

GRADE-IN PROGRAM ANZEA, ARC|COM, ARCHITEX, CARNEGIE, CONCERTEX, DESIGNTEX, DOUGLASS FABRICS, GREENHIDES, LDI INTERIORS, MAHARAM, MAYER FABRICS, MOMENTUM TEXTILES, PANAZ, STINSON, TRINITY (ARGENT, SUSTAINABILITY), AND ULTRAFABRICS MAY BE SPECIFIED TO BE SUPPLIED, AND GRADED-IN BY TRINITY.

NOTE: FOR TEXTILES OVER GRADE 10, CONTACT CUSTOMER SERVICE FOR PRICING.

TRINITY TEXTILE LINKS

THE LINK BELOW PROVIDES MORE INFORMATION CONCERNING UPHOLSTERY OPTIONS.

GRADE-IN FABRICS FROM EACH MANUFACTURER IS SORTED ALPHABETICAL OR BY GRADE, AND ARE AVAILABLE ON OUR WEBSITE.

www.trinityfurniture.com/fabricsleather



Memo Samples:
www.anzea.com
817-336-2310



Memo Samples:
www.arc-com.com
800-223-5466



Memo Samples:
www.architex-ljh.com
800-621-0827



Memo Samples:
www.carnegiefabrics.com
1-800-727-6770



Memo Samples:
www.concertex.com
201-784-8370



Memo Samples:
www.designtex.com
800-221-1540



Memo Samples:
www.douglasfabric.com
800-950-3684



Memo Samples:
www.greenhides.com
336-315-9720



Memo Samples:
www.lidiinteriors.com
866-332-0700



Memo Samples:
www.maharam.com
800-645-3943



Memo Samples:
www.mayerfabrics.com
800-428-4415



Memo Samples:
www.themomgroup.com
800-366-6839



Memo Samples:
www.cfstinson.com
800-841-6279



Memo Samples:
www.trinityfurniture.com/fabricsleather
855-311-6660



Memo Samples:
www.ultrafabricsllc.com
877-309-6648

GS-27F-028DA

71, Part 1 – Office Furniture

Small, Minority Owned Business

May 17, 2021 - May 16, 2026

1a. Special item numbers:

NAICS 337211 Wood Office Furniture

1b. Special item number's lowest unit price:

NAICS 337211 Wood Office Furniture | Style # 855-P \$265.50

2. Maximum order limitation:

NAICS 337211 Wood Office Furniture | \$300,000

3. Minimum order limitation: \$50.00 (Net order value).**4. Geographic coverage:** 48 Contiguous states and District of Columbia.**5. Point of Production:** Trinity Furniture, Inc. Phone: (336) 472-6660

6089 Kennedy Road

Trinity NC 27370

6. Discount: Prices shown are commercial list, discount to be deducted, and includes cartoning. Fifty-five percent of list. (List x .45)**7. Quantity discount, net:****8. Payment terms:** Net 30 Days.**9a. & b. Government Commercial credit cards** are accepted above and below the micropurchase threshold.**10. Foreign items:** None.**11a. Time of delivery:** 49 – 90 days ARO.**11b., c., and d. Expedited delivery, Overnight and second day delivery and urgent requirements:** Contact Customer Service**12. FOB Point:** Origin, Trinity NC**13a. Ordering address:** Trinity Furniture, Inc.

PO Box 150

Trinity NC 27370

Phone: (336) 472-6660

Fax: (336) 475-0037

E-Mail: sales@trinityfurniture.comInternet: www.trinityfurniture.com

Federal ID # 56-1414163

Duns # 11-598-8651

Cage code # 3Z744

CEC # 11699875J

13b. Ordering Procedures: For supplies and series sample BPA order visit www.gsa.gov/portal/content/199353 or www.trinityfurniture.com/federal**14. Payment Address:** Trinity Furniture, Inc.

PO Box 150

Trinity NC 27370

15. Warranty: Trinity Furniture warrants all products for ten (10) years, excluding covering materials, against manufacturing and factory defects, under normal service for the original purchaser. During this period Trinity Furniture, Inc., at our option, will replace, repair, or return the purchase price of any merchandise that, upon our inspection, is deemed to be defective. This constitutes the sole and exclusive remedy to the customer. Damages resulting from freight, claimed or un-claimed, from accident, alternation, tampering, misuse, negligence or abuse voids the warranty. In the event any product has to be returned to the factory for verification of a complaint, it must be shipped prepaid and include written information containing the name of the original purchaser, original invoice number and a copy of the original purchase order. Because of natural variations on materials over which Trinity Furniture has no control, this warranty is applicable only to those parts actually manufactured by Trinity Furniture, Inc. For purchased parts, we will apply exactly the same warranty that is extended to us by our suppliers. Trinity Furniture shall not be liable for consequential or incidental damages arising from any product defects.**16. Export packaging charges:** Quoted upon request.**17. Credit card terms and condition:** Government credit cards are accepted without any additional discounts.**18. Terms and conditions of rental, maintenance and repair:** Not Applicable.**19. Terms and conditions of installation:** Contact customer service.**20a. & b Terms and conditions of repair parts or any other service:** See price list or contact customer service.**21. List of service and distribution points:** Contact customer service.**22. List of participating dealer:** Contact customer service.**23. Preventative maintenance:** Not applicable.**24a. Sustainable attributes:** All of Trinity Furniture's products are certified BIFMA Level 1.**24b. Section 508 compliance for electronic and information technology (if applicable):** Not applicable**25. DUNS:** #11-598-8651**26. CCR:** Yes**27. Uncompensated overtime (indicate if used):** Not used.**28. Restocking terms:** All items are made to order. No returns are accepted.**29. Cancellation terms:** Cancellations cannot be accepted after orders are in production. If the agency insists upon cancellation, we will bill for the portion of the work that has been done plus a 25% restocking/administration charge.

Radcliffe Square

LOUNGE / GUEST / BENCHES / TABLES

Effective: March 1, 2025

T R I N I T Y

Date:

Page:

Modification:

Description:

DESCRIPTION:

- Upholstery Frames: Hardwood & Plywood
- Seat: High Density Polyurethane Foam Over Sheet Webbing
- Back: High Density Polyurethane Foam Over Polypropylene Webbing
- Semi-Attached Cushions: High Density Polydacron (Not Reversible)
- Tight Seat: High Density Polyurethane Foam
- Exposed Wood Frame: Solid Cherry
- Arms: High Density Polyurethane Foam Over Hardwood
- Tablet Arm: Sunburst Patterned Cherry Veneer Over MDF (Cherry Veneer Edgeband)
- 10 Year Warranty

OPTIONS:

- Feather Down & Polyester Pillows Available (See Page 5)
- Specify Exposed Wood Finish (See Page 6)
- Veneer & Solid Surface Tablet Arms May Be Specified

ORIEL LOUNGE

ITEM #: SPECIFICATIONS | GRADES | LIST PRICES:

ARMLESS LOUNGE CHAIR

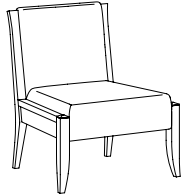

Overall: 28"w 29.25"d 35"h **Arm:** n/a **COM:** 3 yds. (251-P) / 3.25 yds. (251-C)
Seat: 24"w 21.5"d 17.5"h **Weight:** 50 lbs. **COL:** 54 sq.ft. (251-P) / 58.5 sq.ft. (251-C)

| COM | COL | 1 | 2 | 3 | 4 | 5 | 6 | 7 | 8 | 9 | 10 | L1 | L2 | |
|--|------|------|------|------|------|------|------|------|------|------|------|------|------|------|
| 251-P | 1610 | 1771 | 1675 | 1751 | 1828 | 1904 | 1980 | 2057 | 2133 | 2209 | 2286 | 2362 | 2451 | 2726 |
| <i>Tight Seat / Tight Back / 750 lb. Weight Capacity</i> | | | | | | | | | | | | | | |
| 251-C | 1682 | 1851 | 1757 | 1841 | 1924 | 2007 | 2090 | 2174 | 2257 | 2340 | 2424 | 2507 | 2614 | 2914 |
| <i>Semi-Attached Cushion / Tight Back</i> | | | | | | | | | | | | | | |

ARMLESS TWO PLACE SOFA

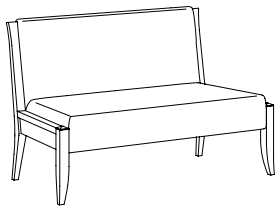

Overall: 52"w 29.25"d 35"h **Arm:** n/a **COM:** 4.75 yds. (252-P) / 5.25 yds. (252-C)
Seat: 48"w 21.5"d 17.5"h **Weight:** 65 lbs. **COL:** 85.5 sq.ft. (252-P) / 94.5 sq.ft. (252-C)

| COM | COL | 1 | 2 | 3 | 4 | 5 | 6 | 7 | 8 | 9 | 10 | L1 | L2 | |
|--|------|------|------|------|------|------|------|------|------|------|------|------|------|------|
| 252-P | 2002 | 2202 | 2101 | 2205 | 2309 | 2413 | 2517 | 2622 | 2726 | 2830 | 2934 | 3038 | 3155 | 3530 |
| <i>Tight Seat / Tight Back / 750 lb. Weight Capacity</i> | | | | | | | | | | | | | | |
| 252-C | 2153 | 2369 | 2272 | 2390 | 2508 | 2626 | 2744 | 2862 | 2980 | 3098 | 3216 | 3334 | 3484 | 3909 |
| <i>Two Semi-Attached Cushions / Tight Back</i> | | | | | | | | | | | | | | |

ARMLESS THREE PLACE SOFA

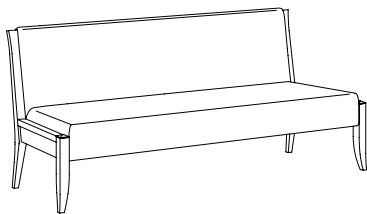

Overall: 77"w 29.25"d 35"h **Arm:** n/a **COM:** 5.25 yds. (253-P) / 6.75 yds. (253-C)
Seat: 73"w 21.5"d 17.5"h **Weight:** 80 lbs. **COL:** 94.5 sq.ft. (252-P) / 121.5 sq.ft. (252-C)

| COM | COL | 1 | 2 | 3 | 4 | 5 | 6 | 7 | 8 | 9 | 10 | L1 | L2 | |
|--|------|------|------|------|------|------|------|------|------|------|------|------|------|------|
| 253-P | 2405 | 2645 | 2551 | 2690 | 2829 | 2968 | 3106 | 3245 | 3384 | 3523 | 3662 | 3801 | 3951 | 4451 |
| <i>Tight Seat / Tight Back / 750 lb. Weight Capacity</i> | | | | | | | | | | | | | | |
| 253-C | 2620 | 2882 | 2838 | 3018 | 3199 | 3379 | 3560 | 3740 | 3921 | 4101 | 4281 | 4462 | 4676 | 5326 |
| <i>Two Semi-Attached Cushions / Tight Back</i> | | | | | | | | | | | | | | |

ARM / TABLET OPTIONS

Arm Height: 25"h **COM:** 1 yd. (Note: Yardage Is Sufficient For 1 or 2 Arms) **Weight:** 5 lbs.
Tablet Arm Height: 16"h **COL:** 18 sq.ft.

NOTE: USE THE FOLLOWING NUMBER SEQUENCE. USE '0' WHEN AN ARM IS NOT DESIRED.



252-P - 1 - 4

ABOVE EXAMPLE:
 AN ARMLESS TWO PLACE SOFA
 WITH FLAIR LEFT FACING ARM
 AND TABLET RIGHT FACING ARM

EACH ARM

| COM | COL | 1 | 2 | 3 | 4 | 5 | 6 | 7 | 8 | 9 | 10 | L1 | L2 |
|-----|-----|-----|-----|-----|-----|-----|-----|-----|-----|-----|-----|-----|-----|
| 195 | 214 | 218 | 235 | 251 | 268 | 285 | 302 | 319 | 336 | 352 | 369 | 381 | 442 |

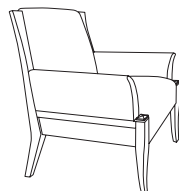

1
FLAIR ARM

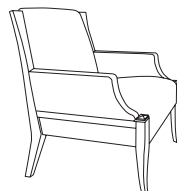

2
NOTCH ARM

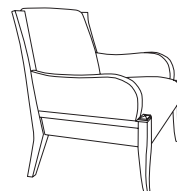

3
SCROLL ARM

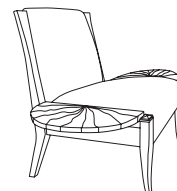

4
TABLET ARM

- 250-4L \$463
Laminate
Tablet Arm
- 250-4V \$662
Veneer
Tablet Arm
- 250-4C \$616
Solid Surface
Tablet Arm

DESCRIPTION:

- Upholstery Frames: Hardwood & Plywood
- Seat: High Density Polyurethane Foam Over Sheet Webbing
- Back: High Density Polyurethane Foam Over Polypropylene Webbing
- Semi-Attached Cushions: High Density Polydacron (Not Reversible)
- Tight Seat: High Density Polyurethane Foam
- Exposed Wood Frame: Solid Cherry
- Arms: High Density Polyurethane Foam Over Hardwood
- Tablet Arm: Sunburst Patterned Cherry Veneer Over MDF (Cherry Veneer Edgeband)
- 10 Year Warranty

OPTIONS:

- Feather Down & Polyester Pillows Available (See Page 5)
- Specify Exposed Wood Finish (See Page 6)
- Veneer & Solid Surface Tablet Arms May Be Specified

ORIEL LOUNGE

ITEM #: SPECIFICATIONS | GRADES | LIST PRICES:

ARMLESS LOUNGE TUFTED CHAIR

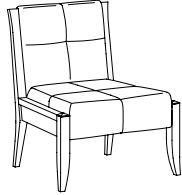

Overall: 28"w 29.25"d 35"h **Arm:** n/a **COM:** 3 yds. (254-P) / 3.5 yds. (254-C)
Seat: 24"w 21.5"d 17.5"h **Weight:** 50 lbs. **COL:** 54 sq.ft. (254-P) / 63 sq.ft. (254-C)

| COM | COL | 1 | 2 | 3 | 4 | 5 | 6 | 7 | 8 | 9 | 10 | L1 | L2 | |
|---|------|------|------|------|------|------|------|------|------|------|------|------|------|------|
| 254-P | 1643 | 1808 | 1706 | 1783 | 1859 | 1935 | 2012 | 2088 | 2164 | 2241 | 2317 | 2394 | 2488 | 2763 |
| <i>Biscuit Tufted Tight Seat / Tight Back / 750 lb. Weight Capacity</i> | | | | | | | | | | | | | | |
| 254-C | 1707 | 1877 | 1794 | 1884 | 1974 | 2065 | 2155 | 2245 | 2335 | 2426 | 2516 | 2606 | 2722 | 3047 |
| <i>Biscuit Tufted Semi-Attached Cushion / Tight Back</i> | | | | | | | | | | | | | | |

ARMLESS TWO PLACE TUFTED SOFA

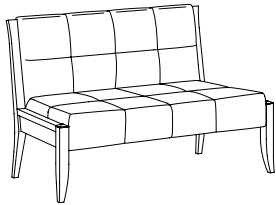

Overall: 52"w 29.25"d 35"h **Arm:** n/a **COM:** 4 yds. (255-P) / 4.5 yds. (255-C)
Seat: 48"w 21.5"d 17.5"h **Weight:** 65 lbs. **COL:** 72 sq.ft. (255-P) / 81 sq.ft. (255-C)

| COM | COL | 1 | 2 | 3 | 4 | 5 | 6 | 7 | 8 | 9 | 10 | L1 | L2 | |
|---|------|------|------|------|------|------|------|------|------|------|------|------|------|------|
| 255-P | 2067 | 2274 | 2163 | 2267 | 2371 | 2475 | 2579 | 2683 | 2787 | 2892 | 2996 | 3100 | 3229 | 3604 |
| <i>Biscuit Tufted Tight Seat / Tight Back / 750 lb. Weight Capacity</i> | | | | | | | | | | | | | | |
| 255-C | 2210 | 2431 | 2326 | 2444 | 2562 | 2680 | 2798 | 2916 | 3034 | 3152 | 3270 | 3388 | 3548 | 3972 |
| <i>Two Biscuit Tufted Semi-Attached Cushions / Tight Back</i> | | | | | | | | | | | | | | |

ARMLESS THREE PLACE TUFTED SOFA

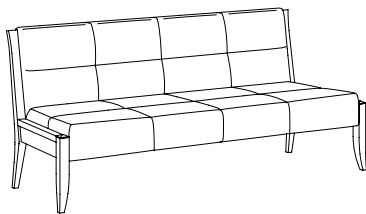

Overall: 77"w 29.25"d 35"h **Arm:** n/a **COM:** 5.25 yds. (256-P) / 6.75 yds. (256-C)
Seat: 73"w 21.5"d 17.5"h **Weight:** 80 lbs. **COL:** 94.5 sq.ft. (256-P) / 121.5 sq.ft. (256-C)

| COM | COL | 1 | 2 | 3 | 4 | 5 | 6 | 7 | 8 | 9 | 10 | L1 | L2 | |
|---|------|------|------|------|------|------|------|------|------|------|------|------|------|------|
| 256-P | 2518 | 2770 | 2658 | 2797 | 2936 | 3075 | 3213 | 3352 | 3491 | 3630 | 3769 | 3908 | 4076 | 4576 |
| <i>Biscuit Tufted Tight Seat / Tight Back / 750 lb. Weight Capacity</i> | | | | | | | | | | | | | | |
| 256-C | 2691 | 2960 | 2905 | 3085 | 3266 | 3446 | 3627 | 3807 | 3988 | 4168 | 4349 | 4529 | 4756 | 5406 |
| <i>Two Biscuit Tufted Semi-Attached Cushions / Tight Back</i> | | | | | | | | | | | | | | |

ARM / TABLET OPTIONS

Arm Height: 25"h **COM:** 1 yd. (Note: Yardage Is Sufficient For 1 or 2 Arms) **Weight:** 5 lbs.
Tablet Arm Height: 16"h **COL:** 18 sq.ft.

NOTE: USE THE FOLLOWING NUMBER SEQUENCE. USE '0' WHEN AN ARM IS NOT DESIRED.



252-P - 1 - 4

ABOVE EXAMPLE:
 AN ARMLESS TWO PLACE SOFA
 WITH FLAIR LEFT FACING ARM
 AND TABLET RIGHT FACING ARM

EACH ARM

| COM | COL | 1 | 2 | 3 | 4 | 5 | 6 | 7 | 8 | 9 | 10 | L1 | L2 |
|-----|-----|-----|-----|-----|-----|-----|-----|-----|-----|-----|-----|-----|-----|
| 195 | 214 | 218 | 235 | 251 | 268 | 285 | 302 | 319 | 336 | 352 | 369 | 381 | 442 |

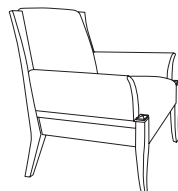

1
FLAIR ARM

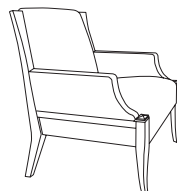

2
NOTCH ARM

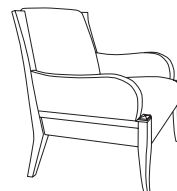

3
SCROLL ARM

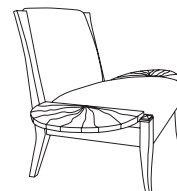

4
TABLET ARM

250-4L \$463
Laminate
Tablet Arm

250-4V \$662
Veneer
Tablet Arm

250-4C \$616
Solid Surface
Tablet Arm

DESCRIPTION:

- Upholstery Frames: Hardwood & Plywood
- Seat: High Density Polyurethane Foam Over Sheet Webbing
- Back: High Density Polyurethane Foam Over Polypropylene Webbing
- Semi-Attached Cushions: High Density Polydacron (Not Reversible)
- Tight Seat: High Density Polyurethane Foam
- Exposed Wood Frame: Solid Cherry
- Arms: High Density Polyurethane Foam Over Hardwood
- Tablet Arm: Sunburst Patterned Cherry Veneer Over MDF (Cherry Veneer Edgeband)
- 10 Year Warranty

OPTIONS:

- Feather Down & Polyester Pillows Available (See Page 5)
- Specify Exposed Wood Finish (See Page 6)
- Veneer & Solid Surface Tablet Arms May Be Specified

QUEEN'S LOUNGE

ITEM #: SPECIFICATIONS | GRADES | LIST PRICES:

ARMLESS LOUNGE CHAIR / CAMEL BACK

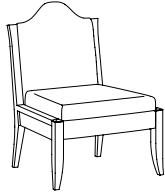

Overall: 28"w 31"d 38"h **Arm:** n/a **COM:** 3 yds. (261-P) / 3.25 yds. (261-C)
Seat: 24"w 21.5"d 17.5"h **Weight:** 50 lbs. **COL:** 54 sq.ft. (261-P) / 58.5 sq.ft. (261-C)

| COM | COL | 1 | 2 | 3 | 4 | 5 | 6 | 7 | 8 | 9 | 10 | L1 | L2 | |
|--|------|------|------|------|------|------|------|------|------|------|------|------|------|------|
| 261-P | 1653 | 1819 | 1716 | 1792 | 1868 | 1945 | 2021 | 2098 | 2174 | 2250 | 2327 | 2403 | 2495 | 2770 |
| <i>Tight Seat / Tight Back / 750 lb. Weight Capacity</i> | | | | | | | | | | | | | | |
| 261-C | 1744 | 1919 | 1816 | 1899 | 1982 | 2066 | 2149 | 2232 | 2315 | 2399 | 2482 | 2565 | 2679 | 2979 |
| <i>Semi-Attached Cushion / Tight Back</i> | | | | | | | | | | | | | | |

ARMLESS TWO PLACE SOFA / CAMEL BACK

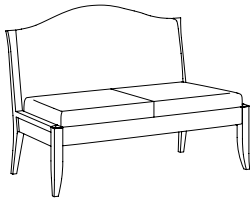

Overall: 52"w 31"d 38"h **Arm:** n/a **COM:** 5.25 yds. (262-P) / 5.75 yds. (262-C)
Seat: 48"w 21.5"d 17.5"h **Weight:** 65 lbs. **COL:** 94.5 sq.ft. (262-P) / 103.5 sq.ft. (262-C)

| COM | COL | 1 | 2 | 3 | 4 | 5 | 6 | 7 | 8 | 9 | 10 | L1 | L2 | |
|--|------|------|------|------|------|------|------|------|------|------|------|------|------|------|
| 262-P | 2107 | 2317 | 2270 | 2408 | 2547 | 2686 | 2825 | 2964 | 3102 | 3241 | 3380 | 3519 | 3669 | 4169 |
| <i>Tight Seat / Tight Back / 750 lb. Weight Capacity</i> | | | | | | | | | | | | | | |
| 262-C | 2264 | 2490 | 2446 | 2598 | 2751 | 2904 | 3056 | 3209 | 3362 | 3514 | 3667 | 3820 | 4003 | 4553 |
| <i>Two Semi-Attached Cushions / Tight Back</i> | | | | | | | | | | | | | | |

ARMLESS THREE PLACE SOFA / CAMEL BACK

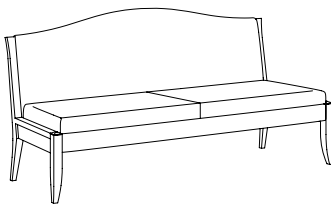

Overall: 77"w 31"d 38"h **Arm:** n/a **COM:** 7.25 yds. (263-P) / 8.75 yds. (263-C)
Seat: 73"w 21.5"d 17.5"h **Weight:** 80 lbs. **COL:** 130.5 sq.ft. (263-P) / 157.5 sq.ft. (263-C)

| COM | COL | 1 | 2 | 3 | 4 | 5 | 6 | 7 | 8 | 9 | 10 | L1 | L2 | |
|--|------|------|------|------|------|------|------|------|------|------|------|------|------|------|
| 263-P | 2531 | 2784 | 2782 | 2976 | 3170 | 3365 | 3559 | 3753 | 3948 | 4142 | 4336 | 4531 | 4728 | 5427 |
| <i>Tight Seat / Tight Back / 750 lb. Weight Capacity</i> | | | | | | | | | | | | | | |
| 263-C | 2741 | 3015 | 3063 | 3299 | 3535 | 3771 | 4007 | 4243 | 4479 | 4715 | 4951 | 5187 | 5447 | 6297 |
| <i>Two Semi-Attached Cushions / Tight Back</i> | | | | | | | | | | | | | | |

ARM / TABLET OPTIONS

Arm Height: 25"h **COM:** 1 yd. (Note: Yardage Is Sufficient For 1 or 2 Arms) **Weight:** 5 lbs.
Tablet Arm Height: 16"h **COL:** 18 sq.ft.

NOTE: USE THE FOLLOWING NUMBER SEQUENCE. USE '0' WHEN AN ARM IS NOT DESIRED.



252-P — 1 — 4

ABOVE EXAMPLE:
 AN ARMLESS TWO PLACE SOFA WITH FLAIR LEFT FACING ARM AND TABLET RIGHT FACING ARM

EACH ARM

| COM | COL | 1 | 2 | 3 | 4 | 5 | 6 | 7 | 8 | 9 | 10 | L1 | L2 |
|-----|-----|-----|-----|-----|-----|-----|-----|-----|-----|-----|-----|-----|-----|
| 195 | 214 | 218 | 235 | 251 | 268 | 285 | 302 | 319 | 336 | 352 | 369 | 381 | 442 |

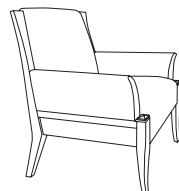

1
FLAIR ARM

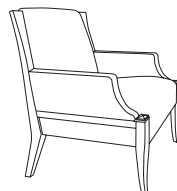

2
NOTCH ARM

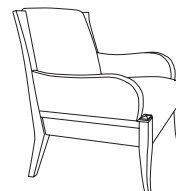

3
SCROLL ARM

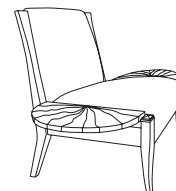

4
TABLET ARM

- 250-4L \$463 Laminated Tablet Arm
- 250-4V \$662 Veneer Tablet Arm
- 250-4C \$616 Solid Surface Tablet Arm

DESCRIPTION:

- Upholstery Frames: Hardwood & Plywood
- Seat: High Density Polyurethane Foam Over Sheet Webbing
- Back: High Density Polyurethane Foam Over Polypropylene Webbing
- Semi-Attached Cushions: High Density Polydacron (Not Reversible)
- Tight Seat: High Density Polyurethane Foam
- Exposed Wood Frame: Solid Cherry
- Arms: High Density Polyurethane Foam Over Hardwood
- Tablet Arm: Sunburst Patterned Cherry Veneer Over MDF (Cherry Veneer Edgeband)
- 10 Year Warranty

OPTIONS:

- Feather Down & Polyester Pillows Available (See Page 5)
- Specify Exposed Wood Finish (See Page 6)
- Veneer & Solid Surface Tablet Arms May Be Specified

PEMBROKE LOUNGE

ITEM #: SPECIFICATIONS | GRADES | LIST PRICES:

ARMLESS LOUNGE CHAIR / FULLY UPHOLSTERED BACK

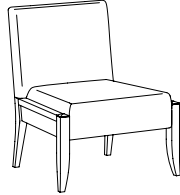

Overall: 28"w 29.25"d 35"h **Arm:** n/a **COM:** 3.25 yds. (271-P) / 3.5 yds. (271-C)
Seat: 24"w 21.5"d 17.5"h **Weight:** 50 lbs. **COL:** 58.5 sq.ft. (271-P) / 63 sq.ft. (271-C)

| COM | COL | 1 | 2 | 3 | 4 | 5 | 6 | 7 | 8 | 9 | 10 | L1 | L2 | |
|--|------|------|------|------|------|------|------|------|------|------|------|------|------|------|
| 271-P | 1655 | 1820 | 1731 | 1814 | 1897 | 1981 | 2064 | 2147 | 2231 | 2314 | 2397 | 2481 | 2581 | 2881 |
| <i>Tight Seat / Tight Back / 750 lb. Weight Capacity</i> | | | | | | | | | | | | | | |
| 271-C | 1733 | 1906 | 1819 | 1909 | 1999 | 2089 | 2180 | 2270 | 2360 | 2450 | 2541 | 2631 | 2750 | 3075 |
| <i>Semi-Attached Cushion / Tight Back</i> | | | | | | | | | | | | | | |

ARMLESS TWO PLACE SOFA / FULLY UPHOLSTERED BACK

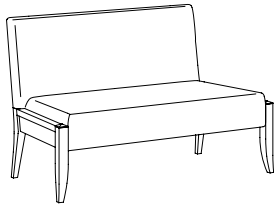

Overall: 52"w 29.25"d 35"h **Arm:** n/a **COM:** 4 yds. (272-P) / 4.5 yds. (272-C)
Seat: 48"w 21.5"d 17.5"h **Weight:** 65 lbs. **COL:** 72 sq.ft. (272-P) / 81 sq.ft. (272-C)

| COM | COL | 1 | 2 | 3 | 4 | 5 | 6 | 7 | 8 | 9 | 10 | L1 | L2 | |
|--|------|------|------|------|------|------|------|------|------|------|------|------|------|------|
| 272-P | 2046 | 2251 | 2143 | 2247 | 2351 | 2455 | 2559 | 2663 | 2768 | 2872 | 2976 | 3080 | 3202 | 3577 |
| <i>Tight Seat / Tight Back / 750 lb. Weight Capacity</i> | | | | | | | | | | | | | | |
| 272-C | 2190 | 2409 | 2307 | 2425 | 2543 | 2661 | 2779 | 2897 | 3015 | 3133 | 3251 | 3369 | 3522 | 3947 |
| <i>Two Semi-Attached Cushions / Tight Back</i> | | | | | | | | | | | | | | |

ARMLESS THREE PLACE SOFA / FULLY UPHOLSTERED BACK

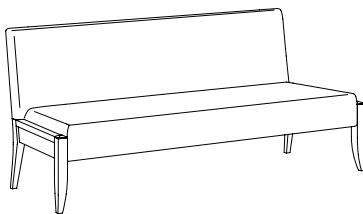

Overall: 77"w 29.25"d 35"h **Arm:** n/a **COM:** 5.25 yds. (273-P) / 6.75 yds. (273-C)
Seat: 73"w 21.5"d 17.5"h **Weight:** 80 lbs. **COL:** 94.5 sq.ft. (273-P) / 121.5 sq.ft. (273-C)

| COM | COL | 1 | 2 | 3 | 4 | 5 | 6 | 7 | 8 | 9 | 10 | L1 | L2 | |
|--|------|------|------|------|------|------|------|------|------|------|------|------|------|------|
| 273-P | 2424 | 2666 | 2569 | 2708 | 2847 | 2985 | 3124 | 3263 | 3402 | 3541 | 3680 | 3818 | 3972 | 4472 |
| <i>Tight Seat / Tight Back / 750 lb. Weight Capacity</i> | | | | | | | | | | | | | | |
| 273-C | 2642 | 2907 | 2859 | 3040 | 3220 | 3401 | 3581 | 3762 | 3942 | 4123 | 4303 | 4483 | 4701 | 5351 |
| <i>Two Semi-Attached Cushions / Tight Back</i> | | | | | | | | | | | | | | |

ARM / TABLET OPTIONS

Arm Height: 25"h **COM:** 1 yd. (Note: Yardage Is Sufficient For 1 or 2 Arms) **Weight:** 5 lbs.
Tablet Arm Height: 16"h **COL:** 18 sq.ft.

NOTE: USE THE FOLLOWING NUMBER SEQUENCE. USE '0' WHEN AN ARM IS NOT DESIRED.

ITEM NUMBER — LEFT ARM FACING — RIGHT ARM FACING

252-P — 1 — 4

ABOVE EXAMPLE:
 AN ARMLESS TWO PLACE SOFA WITH FLAIR LEFT FACING ARM AND TABLET RIGHT FACING ARM

EACH ARM

| COM | COL | 1 | 2 | 3 | 4 | 5 | 6 | 7 | 8 | 9 | 10 | L1 | L2 |
|-----|-----|-----|-----|-----|-----|-----|-----|-----|-----|-----|-----|-----|-----|
| 195 | 214 | 218 | 235 | 251 | 268 | 285 | 302 | 319 | 336 | 352 | 369 | 381 | 442 |

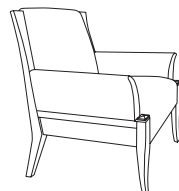

1
FLAIR ARM

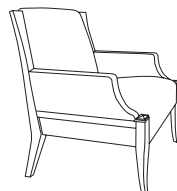

2
NOTCH ARM

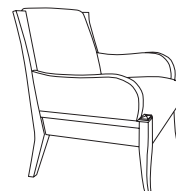

3
SCROLL ARM

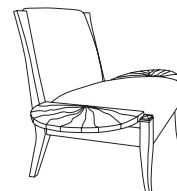

4
TABLET ARM

250-4L \$463
Laminate
Tablet Arm

250-4V \$662
Veneer
Tablet Arm

250-4C \$616
Solid Surface
Tablet Arm

DESCRIPTION:

- Upholstery Frames: Hardwood & Plywood
- Seat: High Density Polyurethane Foam Over Sheet Webbing
- Back: High Density Polyurethane Foam Over Polypropylene Webbing
- Semi-Attached Cushions: High Density Polydacron (Not Reversible)
- Tight Seat: High Density Polyurethane Foam
- Exposed Wood Frame: Solid Cherry
- Arms: High Density Polyurethane Foam Over Hardwood
- Tablet Arm: Sunburst Patterned Cherry Veneer Over MDF (Cherry Veneer Edgeband)
- 10 Year Warranty

OPTIONS:

- Feather Down & Polyester Pillows Available (See Page 5)
- Specify Exposed Wood Finish (See Page 6)
- Veneer & Solid Surface Tablet Arms May Be Specified

PEMBROKE LOUNGE

ITEM #:

SPECIFICATIONS | GRADES | LIST PRICES:

ARMLESS LOUNGE CHAIR / FULLY UPH. BACK / SEWN TUFTING

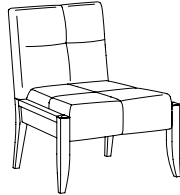

Overall: 28"w 29.25"d 35"h **Arm:** n/a **COM:** 3.25 yds. (274-P) / 3.5 yds. (274-C)
Seat: 24"w 21.5"d 17.5"h **Weight:** 50 lbs. **COL:** 54 sq.ft. (274-P) / 63 sq.ft. (274-C)

| COM | COL | 1 | 2 | 3 | 4 | 5 | 6 | 7 | 8 | 9 | 10 | L1 | L2 | |
|---|------|------|------|------|------|------|------|------|------|------|------|------|------|------|
| 274-P | 1688 | 1857 | 1748 | 1825 | 1901 | 1977 | 2054 | 2130 | 2207 | 2283 | 2359 | 2436 | 2538 | 2812 |
| <i>Biscuit Tufted Tight Seat / Tight Back / 750 lb. Weight Capacity</i> | | | | | | | | | | | | | | |
| 274-C | 1751 | 1926 | 1836 | 1926 | 2016 | 2107 | 2197 | 2287 | 2377 | 2468 | 2558 | 2648 | 2771 | 3096 |
| <i>Biscuit Tufted Semi-Attached Cushion / Tight Back</i> | | | | | | | | | | | | | | |

ARMLESS TWO PLACE SOFA / FULLY UPH. BACK / SEWN TUFTING

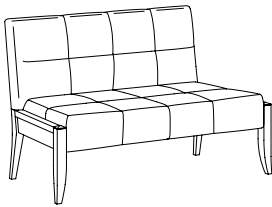

Overall: 52"w 29.25"d 35"h **Arm:** n/a **COM:** 4 yds. (275-P) / 4.5 yds. (275-C)
Seat: 48"w 21.5"d 17.5"h **Weight:** 65 lbs. **COL:** 72 sq.ft. (275-P) / 81 sq.ft. (275-C)

| COM | COL | 1 | 2 | 3 | 4 | 5 | 6 | 7 | 8 | 9 | 10 | L1 | L2 | |
|---|------|------|------|------|------|------|------|------|------|------|------|------|------|------|
| 275-P | 2108 | 2318 | 2201 | 2305 | 2409 | 2513 | 2617 | 2722 | 2826 | 2930 | 3034 | 3138 | 3272 | 3647 |
| <i>Biscuit Tufted Tight Seat / Tight Back / 750 lb. Weight Capacity</i> | | | | | | | | | | | | | | |
| 275-C | 2251 | 2476 | 2364 | 2482 | 2600 | 2718 | 2836 | 2954 | 3072 | 3190 | 3308 | 3426 | 3590 | 4015 |
| <i>Two Biscuit Tufted Semi-Attached Cushions / Tight Back</i> | | | | | | | | | | | | | | |

ARMLESS THREE PLACE SOFA / FULLY UPH. BACK / SEWN TUFTING

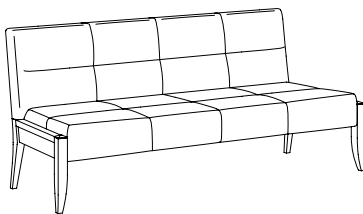

Overall: 77"w 29.25"d 35"h **Arm:** n/a **COM:** 5.25 yds. (276-P) / 6.75 yds. (276-C)
Seat: 73"w 21.5"d 17.5"h **Weight:** 80 lbs. **COL:** 94.5 sq.ft. (276-P) / 121.5 sq.ft. (276-C)

| COM | COL | 1 | 2 | 3 | 4 | 5 | 6 | 7 | 8 | 9 | 10 | L1 | L2 | |
|---|------|------|------|------|------|------|------|------|------|------|------|------|------|------|
| 276-P | 2516 | 2768 | 2656 | 2795 | 2934 | 3073 | 3212 | 3350 | 3489 | 3628 | 3767 | 3906 | 4075 | 4575 |
| <i>Biscuit Tufted Tight Seat / Tight Back / 750 lb. Weight Capacity</i> | | | | | | | | | | | | | | |
| 276-C | 2707 | 2977 | 2920 | 3100 | 3281 | 3461 | 3642 | 3822 | 4003 | 4183 | 4364 | 4544 | 4772 | 5422 |
| <i>Two Biscuit Tufted Semi-Attached Cushions / Tight Back</i> | | | | | | | | | | | | | | |

ARM / TABLET OPTIONS

Arm Height: 25"h **COM:** 1 yd. (Note: Yardage Is Sufficient For 1 or 2 Arms) **Weight:** 5 lbs.
Tablet Arm Height: 16"h **COL:** 18 sq.ft.

NOTE: USE THE FOLLOWING NUMBER SEQUENCE. USE '0' WHEN AN ARM IS NOT DESIRED.

ITEM NUMBER — LEFT ARM FACING — RIGHT ARM FACING

252-P — 1 — 4

ABOVE EXAMPLE:
 AN ARMLESS TWO PLACE SOFA WITH FLAIR LEFT FACING ARM AND TABLET RIGHT FACING ARM

EACH ARM

| COM | COL | 1 | 2 | 3 | 4 | 5 | 6 | 7 | 8 | 9 | 10 | L1 | L2 |
|-----|-----|-----|-----|-----|-----|-----|-----|-----|-----|-----|-----|-----|-----|
| 195 | 214 | 218 | 235 | 251 | 268 | 285 | 302 | 319 | 336 | 352 | 369 | 381 | 442 |

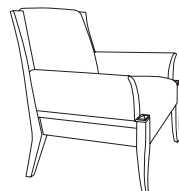

1
FLAIR ARM

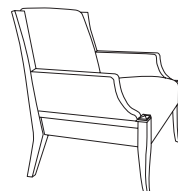

2
NOTCH ARM

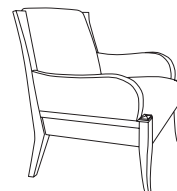

3
SCROLL ARM

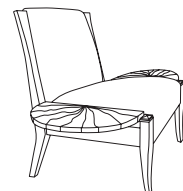

4
TABLET ARM

250-4L \$463
Laminate
Tablet Arm

250-4V \$662
Veneer
Tablet Arm

250-4C \$616
Solid Surface
Tablet Arm

DESCRIPTION:

- Upholstery Frames: Hardwood & Plywood
- Seat: High Density Polyurethane Foam Over Sheet Webbing
- Back: High Density Polyurethane Foam Over Polypropylene Webbing
- Semi-Attached Cushions: High Density Polydacron (Not Reversible)
- Tight Seat: High Density Polyurethane Foam
- Exposed Wood Frame: Solid Cherry
- Arms: High Density Polyurethane Foam Over Hardwood
- Tablet Arm: Sunburst Patterned Cherry Veneer Over MDF (Cherry Veneer Edgeband)
- 10 Year Warranty

OPTIONS:

Specify Exposed Wood Finish (See Page 6)
 Veneer & Solid Surface Tablet Arms May Be Specified

CATTE STREET CHAIRS

ARMLESS SIDE CHAIR / EXPOSED WOOD BACK POSTS



| ITEM #: | SPECIFICATIONS GRADES LIST PRICES: | | | | | | | | | | | | | |
|--------------|--|------|------|------|------------------------|------|------|------|---|------|------|------|------|------|
| | Overall: 23"w 23.75"d 33"h | | | | Arm: n/a | | | | COM: 2 yds. (291-P) / 2.25 yds. (291-C) | | | | | |
| | Seat: 19.75"w 18"d 18.5"h | | | | Weight: 25 lbs. | | | | COL: 36 sq.ft. (291-P) / 40.5 sq.ft. (291-C) | | | | | |
| | COM | COL | 1 | 2 | 3 | 4 | 5 | 6 | 7 | 8 | 9 | 10 | L1 | L2 |
| 291-P | 947 | 1042 | 993 | 1041 | 1090 | 1138 | 1187 | 1236 | 1284 | 1333 | 1381 | 1430 | 1496 | 1671 |
| | <i>Tight Seat / Tight Back / 350 lb. Weight Capacity</i> | | | | | | | | | | | | | |
| 291-C | 1040 | 1144 | 1094 | 1150 | 1205 | 1261 | 1316 | 1372 | 1427 | 1483 | 1538 | 1594 | 1679 | 1879 |
| | <i>Semi-Attached Cushion / Tight Back</i> | | | | | | | | | | | | | |

ARMLESS SIDE CHAIR / CAMEL BACK / EXPOSED WOOD BACK POSTS



| | Overall: 23"w 23.75"d 35.5"h | | | | Arm: n/a | | | | COM: 2.25 yds. (292-P) / 2.25 yds. (292-C) | | | | | |
|--------------|--|------|------|------|------------------------|------|------|------|---|------|------|------|------|------|
| | Seat: 19.75"w 18"d 18.5"h | | | | Weight: 25 lbs. | | | | COL: 40.5 sq.ft. (292-P) / 40.5 sq.ft. (292-C) | | | | | |
| | COM | COL | 1 | 2 | 3 | 4 | 5 | 6 | 7 | 8 | 9 | 10 | L1 | L2 |
| 292-P | 991 | 1090 | 1048 | 1104 | 1159 | 1215 | 1270 | 1326 | 1381 | 1437 | 1492 | 1548 | 1624 | 1824 |
| | <i>Tight Seat / Tight Back / 350 lb. Weight Capacity</i> | | | | | | | | | | | | | |
| 292-C | 1084 | 1192 | 1136 | 1191 | 1247 | 1302 | 1358 | 1413 | 1469 | 1524 | 1580 | 1635 | 1726 | 1926 |
| | <i>Semi-Attached Cushion / Tight Back</i> | | | | | | | | | | | | | |

ARMLESS SIDE CHAIR / UPH. LOWER BACK / EXPOSED WOOD TOP BACK

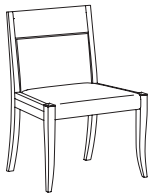

| | Overall: 23"w 23.75"d 33"h | | | | Arm: n/a | | | | COM: 1.75 yds. (293-P) / 2.25 yds. (293-C) | | | | | |
|--------------|--|------|------|------|------------------------|------|------|------|---|------|------|------|------|------|
| | Seat: 19.75"w 18"d 18.5"h | | | | Weight: 25 lbs. | | | | COL: 31.5 sq.ft. (293-P) / 40.5 sq.ft. (293-C) | | | | | |
| | COM | COL | 1 | 2 | 3 | 4 | 5 | 6 | 7 | 8 | 9 | 10 | L1 | L2 |
| 293-P | 1083 | 1191 | 1107 | 1149 | 1191 | 1232 | 1274 | 1316 | 1357 | 1399 | 1440 | 1482 | 1555 | 1705 |
| | <i>Tight Seat / Tight Back / 350 lb. Weight Capacity</i> | | | | | | | | | | | | | |
| 293-C | 1181 | 1300 | 1228 | 1284 | 1339 | 1395 | 1450 | 1506 | 1561 | 1617 | 1672 | 1728 | 1825 | 2025 |
| | <i>Semi-Attached Cushion / Tight Back</i> | | | | | | | | | | | | | |

ARMLESS SIDE CHAIR / FULLY UPH. BACK / BISCUIT TUFTED



| | Overall: 23"w 23.75"d 33"h | | | | Arm: n/a | | | | COM: 2.25 yds. (294-P) / 2.25 yds. (294-C) | | | | | |
|--------------|---|------|------|------|------------------------|------|------|------|---|------|------|------|------|------|
| | Seat: 19.75"w 18"d 18.5"h | | | | Weight: 25 lbs. | | | | COL: 40.5 sq.ft. (294-P) / 40.5 sq.ft. (294-C) | | | | | |
| | COM | COL | 1 | 2 | 3 | 4 | 5 | 6 | 7 | 8 | 9 | 10 | L1 | L2 |
| 294-P | 996 | 1095 | 1025 | 1066 | 1108 | 1150 | 1191 | 1233 | 1275 | 1316 | 1358 | 1400 | 1508 | 1658 |
| | <i>Biscuit Tufted Tight Seat / Tight Back / 350 lb. Weight Capacity</i> | | | | | | | | | | | | | |
| 294-C | 1092 | 1201 | 1143 | 1199 | 1254 | 1310 | 1365 | 1421 | 1476 | 1532 | 1587 | 1643 | 1789 | 1989 |
| | <i>Biscuit Tufted Semi-Attached Cushion / Tight Back</i> | | | | | | | | | | | | | |

ARM / TABLET OPTIONS

Arm Height: 25"h **COM:** 1 yd. (Note: Yardage Is Sufficient For 1 or 2 Arms) **Weight:** 5 lbs.
Tablet Arm Height: 16"h **COL:** 18 sq.ft.

NOTE: USE THE FOLLOWING NUMBER SEQUENCE. USE '0' WHEN AN ARM IS NOT DESIRED.

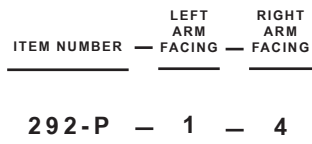

EACH ARM

| COM | COL | 1 | 2 | 3 | 4 | 5 | 6 | 7 | 8 | 9 | 10 | L1 | L2 |
|-----------|-----------|------------|------------|-----|-----|-----|-----|-----|-----|-----|-----|-----|---------------------------------------|
| 137 | 150 | 163 | 180 | 197 | 213 | 230 | 247 | 264 | 281 | 298 | 314 | 326 | 387 |
| | | | | | | | | | | | | | |
| 1 | 2 | 3 | 4 | | | | | | | | | | |
| FLAIR ARM | NOTCH ARM | SCROLL ARM | TABLET ARM | | | | | | | | | | |
| | | | | | | | | | | | | | 290-4L \$424 Laminated Tablet Arm |
| | | | | | | | | | | | | | 290-4V \$470 Veneer Tablet Arm |
| | | | | | | | | | | | | | 290-4C \$516 Solid Surface Tablet Arm |

ABOVE EXAMPLE:
 AN ARMLESS SIDE CHAIR WITH FLAIR LEFT FACING ARM AND TABLET RIGHT FACING ARM

DESCRIPTION:

- Upholstery Frames: Hardwood & Plywood
- Tight Seat: High Density Polyurethane Foam Over Sheet Webbing
- Semi-Attached Cushions: High Density Polydacron (Not Reversible)
- Exposed Wood Frame: Solid Cherry
- Tablet Arm: Sunburst Patterned Cherry Veneer Over MDF (Cherry Veneer Edgeband)
- 10 Year Warranty

OPTIONS:

Specify Exposed Wood Finish (See Page 6)
 Veneer & Solid Surface Tablet Arms May Be Specified

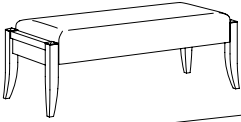
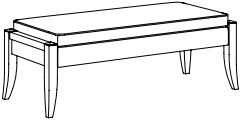
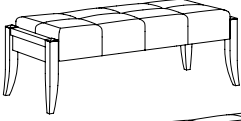
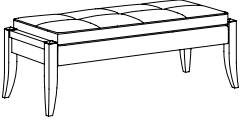
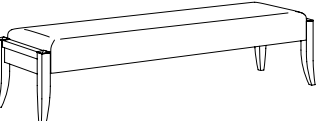
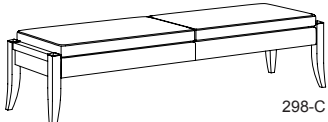
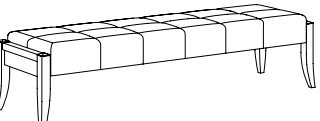
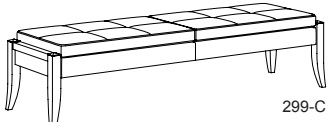
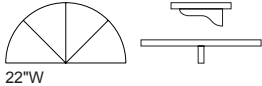
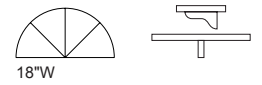
| BENCHES / TABLET ARMS | | ITEM #: | SPECIFICATIONS GRADES LIST PRICES: | | | | | | | | | | | | | | |
|---|-------|---------------|--|------------|----------|------------------------|---------------|---|---|----------|---|----------|----------|-----------|-----------|-----------|--|
| BENCH / PLAIN TAILORING | | | Overall: 52"w 20.5"d 18"h | | | Arm: n/a | | | COM: 2.25 yds. (296-P) / 3 yds. (296-C) | | | | | | | | |
| | | | Seat: 48"w 20.5"d 18"h | | | Weight: 45 lbs. | | | COL: 40.5 sq.ft. (296-P) / 54 sq.ft. (296-C) | | | | | | | | |
|  | | | COM | COL | 1 | 2 | 3 | 4 | 5 | 6 | 7 | 8 | 9 | 10 | L1 | L2 | |
| 296-P | | 296-P | 1028 | 1131 | 1083 | 1139 | 1194 | 1250 | 1305 | 1361 | 1417 | 1472 | 1528 | 1583 | 1640 | 1840 | |
| | | | <i>Tight Seat / 750 lb. Weight Capacity</i> | | | | | | | | | | | | | | |
|  | | | COM | COL | 1 | 2 | 3 | 4 | 5 | 6 | 7 | 8 | 9 | 10 | L1 | L2 | |
| | 296-C | 296-C | 1113 | 1224 | 1205 | 1281 | 1357 | 1434 | 1510 | 1586 | 1663 | 1739 | 1815 | 1892 | 1977 | 2252 | |
| | | | <i>Semi-Attached Cushion</i> | | | | | | | | | | | | | | |
| BENCH / SEWN BISCUIT TUFTING | | | Overall: 52"w 20.5"d 18"h | | | Arm: n/a | | | COM: 2.25 yds. (297-P) / 3 yds. (297-C) | | | | | | | | |
| | | | Seat: 48"w 20.5"d 18"h | | | Weight: 45 lbs. | | | COL: 40.5 sq.ft. (297-P) / 54 sq.ft. (297-C) | | | | | | | | |
|  | | | COM | COL | 1 | 2 | 3 | 4 | 5 | 6 | 7 | 8 | 9 | 10 | L1 | L2 | |
| 297-P | | 297-P | 1079 | 1187 | 1131 | 1187 | 1242 | 1298 | 1353 | 1409 | 1464 | 1520 | 1576 | 1631 | 1698 | 1898 | |
| | | | <i>Biscuit Tufted Tight Seat / 750 lb. Weight Capacity</i> | | | | | | | | | | | | | | |
|  | | | COM | COL | 1 | 2 | 3 | 4 | 5 | 6 | 7 | 8 | 9 | 10 | L1 | L2 | |
| | 297-C | 297-C | 1160 | 1276 | 1250 | 1326 | 1402 | 1479 | 1555 | 1631 | 1708 | 1784 | 1860 | 1937 | 2031 | 2306 | |
| | | | <i>Biscuit Tufted Semi-Attached Cushion</i> | | | | | | | | | | | | | | |
| BENCH / PLAIN TAILORING | | | Overall: 72"w 20.5"d 18"h | | | Arm: n/a | | | COM: 3 yds. (298-P) / 4 yds. (298-C) | | | | | | | | |
| | | | Seat: 68"w 20.5"d 18"h | | | Weight: 55 lbs. | | | COL: 54 sq.ft. (298-P) / 72 sq.ft. (298-C) | | | | | | | | |
|  | | | COM | COL | 1 | 2 | 3 | 4 | 5 | 6 | 7 | 8 | 9 | 10 | L1 | L2 | |
| 298-P | | 298-P | 1370 | 1507 | 1448 | 1524 | 1601 | 1677 | 1753 | 1830 | 1906 | 1982 | 2059 | 2135 | 2216 | 2491 | |
| | | | <i>Tight Seat / 750 lb. Weight Capacity</i> | | | | | | | | | | | | | | |
|  | | | COM | COL | 1 | 2 | 3 | 4 | 5 | 6 | 7 | 8 | 9 | 10 | L1 | L2 | |
| | 298-C | 298-C | 1451 | 1596 | 1580 | 1684 | 1789 | 1893 | 1997 | 2101 | 2205 | 2309 | 2413 | 2517 | 2633 | 3008 | |
| | | | <i>Two Semi-Attached Cushions</i> | | | | | | | | | | | | | | |
| BENCH / SEWN BISCUIT TUFTING | | | Overall: 72"w 20.5"d 18"h | | | Arm: n/a | | | COM: 3 yds. (299-P) / 4 yds. (299-C) | | | | | | | | |
| | | | Seat: 68"w 20.5"d 18"h | | | Weight: 55 lbs. | | | COL: 54 sq.ft. (299-P) / 72 sq.ft. (299-C) | | | | | | | | |
|  | | | COM | COL | 1 | 2 | 3 | 4 | 5 | 6 | 7 | 8 | 9 | 10 | L1 | L2 | |
| 299-P | | 299-P | 1412 | 1553 | 1487 | 1564 | 1640 | 1716 | 1793 | 1869 | 1945 | 2022 | 2098 | 2174 | 2332 | 2607 | |
| | | | <i>Biscuit Tufted Tight Seat / 750 lb. Weight Capacity</i> | | | | | | | | | | | | | | |
|  | | | COM | COL | 1 | 2 | 3 | 4 | 5 | 6 | 7 | 8 | 9 | 10 | L1 | L2 | |
| | 299-C | 299-C | 1499 | 1649 | 1625 | 1729 | 1834 | 1938 | 2042 | 2146 | 2250 | 2354 | 2458 | 2562 | 2781 | 3156 | |
| | | | <i>Two Biscuit Tufted Semi-Attached Cushions</i> | | | | | | | | | | | | | | |
| TABLET ARMS | | | Overall: 22"w 11"d 16"h (250-4L-4V-4C) / 18"w 9"d 16"h (290-4L-4V-4C) | | | | | | | | | | | | | | |
| | | | Weight: 10 lbs. (250-4L-4V-4C) / 5 lbs. (290-4L-4V-4C) | | | | | | | | | | | | | | |
|  | | 250-4L | \$463 Laminate Tablet Arm - 22"w (Lounge) | | | | 290-4L | \$424 Laminate Tablet Arm - 18"w (Guest / Bench) | | | | | | | | | |
| | | | <i>High Pressure Laminate Face / Self Edge</i> | | | | | | | | <i>High Pressure Laminate Face / Self Edge</i> | | | | | | |
|  | | 250-4V | \$662 Veneer Tablet Arm - 22"w (Lounge) | | | | 290-4V | \$470 Veneer Tablet Arm - 18"w (Guest / Bench) | | | | | | | | | |
| | | | <i>Sunburst Veneer Face / Vertical Grain Edgeband</i> | | | | | | | | <i>Sunburst Veneer Face / Vertical Grain Edgeband</i> | | | | | | |
| | | 250-4C | \$616 Solid Surface Tablet Arm - 22"w (Lounge) | | | | 290-4C | \$516 Solid Surface Tablet Arm - 18"w (Guest / Bench) | | | | | | | | | |
| | | | <i>Solid Surface Face / Self Edge</i> | | | | | | | | <i>Solid Surface Face / Self Edge</i> | | | | | | |

Tablet Arm Is Non-Handed / May Be Used On Left Or Right Side

DESCRIPTION:

- Solid Cherry Legs & Rails
- Cherry Veneer Top Banded With Cherry Veneer
- 10 Year Warranty

OPTIONS:

Specify Exposed Wood Finish (See Page 6)

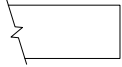

Square Edge Profile Standard

| CAMERA TABLES | | ITEM #: | SPECIFICATIONS GRADES LIST PRICES: | | | | | | | | | | | | | |
|------------------|--|-----------|---|-----|---|---|---|---|---|---|---|---|---|----|----|----|
| LOW TABLE | | | Overall: 16"dia 18"h Weight: 20 lbs. | | | | | | | | | | | | | |
| | | | COM | COL | 1 | 2 | 3 | 4 | 5 | 6 | 7 | 8 | 9 | 10 | L1 | L2 |
| | | 2516D18-L | 853 <i>High Pressure Laminate Face / Self Edge</i> | | | | | | | | | | | | | |
| | | 2516D18-V | 1018 <i>Sunburst Veneer Face / Vertical Grain Edgeband</i> | | | | | | | | | | | | | |
| | | 2516D18-C | 1042 <i>Solid Surface Face / Self Edge</i> | | | | | | | | | | | | | |
| TABLE WITH SHELF | | | Overall: 18"dia 22"h Weight: 25 lbs. | | | | | | | | | | | | | |
| | | | COM | COL | 1 | 2 | 3 | 4 | 5 | 6 | 7 | 8 | 9 | 10 | L1 | L2 |
| | | 2518D22-L | 1360 <i>High Pressure Laminate Face / Self Edge</i> | | | | | | | | | | | | | |
| | | 2518D22-V | 1598 <i>Sunburst Veneer Face & Shelf / Vertical Grain Edgeband</i> | | | | | | | | | | | | | |
| | | 2518D22-C | 1518 <i>Solid Surface Face / Self Edge</i> | | | | | | | | | | | | | |
| COFFEE TABLE | | | Overall: 22"dia 16"h Weight: 30 lbs. | | | | | | | | | | | | | |
| | | | COM | COL | 1 | 2 | 3 | 4 | 5 | 6 | 7 | 8 | 9 | 10 | L1 | L2 |
| | | 2522D16-L | 946 <i>High Pressure Laminate Face / Self Edge</i> | | | | | | | | | | | | | |
| | | 2522D16-V | 1227 <i>Sunburst Veneer Face / Vertical Grain Edgeband</i> | | | | | | | | | | | | | |
| | | 2522D16-C | 1276 <i>Solid Surface Face / Self Edge</i> | | | | | | | | | | | | | |
| COFFEE TABLE | | | Overall: 36"dia 16"h Weight: 57 lbs. | | | | | | | | | | | | | |
| | | | COM | COL | 1 | 2 | 3 | 4 | 5 | 6 | 7 | 8 | 9 | 10 | L1 | L2 |
| | | 2536D16-L | 1401 <i>High Pressure Laminate Face / Self Edge</i> | | | | | | | | | | | | | |
| | | 2536D16-V | 2378 <i>Sunburst Veneer Face / Vertical Grain Edgeband</i> | | | | | | | | | | | | | |
| | | 2536D16-C | 2506 <i>Solid Surface Face / Self Edge</i> | | | | | | | | | | | | | |

DESCRIPTION:

- Solid Cherry Legs & Rails
- Cherry Veneer Top Banded With Cherry Veneer
- 10 Year Warranty

OPTIONS:

Specify Exposed Wood Finish (See Page 6)

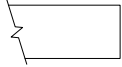

Square Edge Profile Standard

TABLES

ITEM #:

SPECIFICATIONS | GRADES | LIST PRICES:

END TABLE

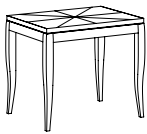
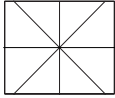

252420-L

252420-V

252420-C

Overall: 24"w 20"d 22"h
Weight: 35 lbs.

| COM | COL | 1 | 2 | 3 | 4 | 5 | 6 | 7 | 8 | 9 | 10 | L1 | L2 |
|-----|-----|---|---|---|---|---|---|---|---|---|----|----|----|
|-----|-----|---|---|---|---|---|---|---|---|---|----|----|----|

971
High Pressure Laminate Face / Self Edge

1203
Sunburst Veneer Face / Vertical Grain Edgeband

1374
Solid Surface Face / Self Edge

END TABLE

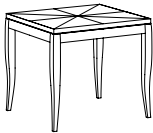
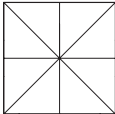

252424-L

252424-V

252424-C

Overall: 24"w 24"d 22"h
Weight: 40 lbs.

| COM | COL | 1 | 2 | 3 | 4 | 5 | 6 | 7 | 8 | 9 | 10 | L1 | L2 |
|-----|-----|---|---|---|---|---|---|---|---|---|----|----|----|
|-----|-----|---|---|---|---|---|---|---|---|---|----|----|----|

1010
High Pressure Laminate Face / Self Edge

1272
Sunburst Veneer Face / Vertical Grain Edgeband

1541
Solid Surface Face / Self Edge

COFFEE TABLE

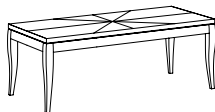
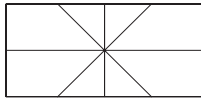

254220-L

254220-V

254220-C

Overall: 42"w 20"d 16"h
Weight: 45 lbs.

| COM | COL | 1 | 2 | 3 | 4 | 5 | 6 | 7 | 8 | 9 | 10 | L1 | L2 |
|-----|-----|---|---|---|---|---|---|---|---|---|----|----|----|
|-----|-----|---|---|---|---|---|---|---|---|---|----|----|----|

1173
High Pressure Laminate Face / Self Edge

1722
Sunburst Veneer Face / Vertical Grain Edgeband

2088
Solid Surface Face / Self Edge

OVAL COFFEE TABLE

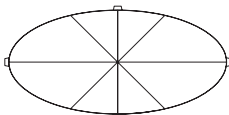

2548E16-L

2548E16-V

2548E16-C

Overall: 48"w 24"d 16"h
Weight: 50 lbs.

| COM | COL | 1 | 2 | 3 | 4 | 5 | 6 | 7 | 8 | 9 | 10 | L1 | L2 |
|-----|-----|---|---|---|---|---|---|---|---|---|----|----|----|
|-----|-----|---|---|---|---|---|---|---|---|---|----|----|----|

1532
High Pressure Laminate Face / Self Edge

2313
Sunburst Veneer Face / Vertical Grain Edgeband

2509
Solid Surface Face / Self Edge

DESCRIPTION:

- Solid Cherry Legs & Rails
- Cherry Veneer Top Banded With Cherry Veneer
- 10 Year Warranty

OPTIONS:

Specify Exposed Wood Finish (See Page 6)



Square Edge Profile Standard

TABLES

ITEM #:

SPECIFICATIONS | GRADES | LIST PRICES:

SOFA TABLE

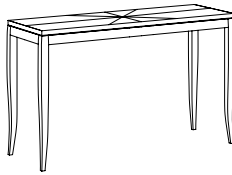
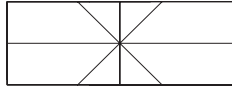

Overall: 48"w 18"d 30"h
Weight: 50 lbs.

| COM | COL | 1 | 2 | 3 | 4 | 5 | 6 | 7 | 8 | 9 | 10 | L1 | L2 |
|-----|-----|---|---|---|---|---|---|---|---|---|----|----|----|
|-----|-----|---|---|---|---|---|---|---|---|---|----|----|----|

254818-L





1335
High Pressure Laminate Face / Self Edge

254818-V

1842
Sunburst Veneer Face / Vertical Grain Edgeband

254818-C

2080
Solid Surface Face / Self Edge

| POWER / COVERS | OPTION #: | SPECIFICATIONS LIST PRICES AVAILABILITY: |
|--|---|---|
| <p>POWER / DATA MODULE</p>  <p>PM1 Power / Data Module</p>  <p>PM2 Power Module</p>  <p>USB-1 Dual Charging USB</p> | <p>PM1</p> <p>PM2</p> <p>USB-1</p> | <p>PM1 Overall: 5.25"w 1.25"d 4.25"h PM2 Overall: 2"w 2"d .125"h USB-1 Overall: 2"w 2"d .125"h</p> <hr/> <p>\$859 Power/Data Module (1-Power / 1-USB 2 Port Simplex Charger Standard) <i>Vertical / Horizontal Mount Power Module. Price Varies By Socket. Contact Customer Service For Quote. (Additional Colors Available)</i></p> <p>\$238 Power Module (1-Power) <i>Spill-Proof Technology / Multiple Finish Options / Storm Color Standard (Specify Left or Right Facing)</i></p> <p>\$238 Dual Charging USB (2 Port Simplex Charger Standard) <i>Spill-Proof Technology / 2 Amps Per Port / Multiple Finish Options / Storm Color Standard (Specify Left or Right Facing)</i></p> <p>Available: Radcliffe Square Collection</p> |
| <p>CONTRASTING COVERS</p>  | <p>CC</p> | <p>Overall: n/a</p> <hr/> <p>\$129 <i>NOTE: If Two Or More Upholsteries Or Leathers Are Used On Any Piece Of Furniture, Then A Contrast Charge Will Apply Per Order. When Using Trinity Upholstery, The Higher Priced Upholstery Grade Will Be Used In Pricing, Unless It's Trinity Leather With Fabric Contrast Welt, Or COM With Trinity Contrast Welt, Then Contact Customer Service For Pricing.</i></p> <p>Available: Radcliffe Square Collection</p> |

Cilo²

EXECUTIVE SEATING

Effective: March 1, 2025

T R I N I T Y

Date:

Page:

Modification:

Description:

DESCRIPTION:









- Upholstery Frames: Curved Plywood & Hardwood
- Seat / Back: High Density Polyurethane Foam
- Aluminum Arms: Polished Cast Aluminum Arm Fitted w/ Black Rigid Polyurethane Arm Insert
- 10 Year Warranty

OPTIONS:

- Polished Aluminum Base / Tilt Swivel w/ Lock / Pneumatic Seat Height Adj.....\$120
- Note: For All (-2) Item Numbers**
- Polished Aluminum Base / Knee Tilt Swivel / Pneumatic Seat Height Adj.....\$120
- Note: For All (-4) Item Numbers**
- UA1 Cilo² Upholstered Arms (308 / 311 Chairs Only)..... Call For Pricing
- UA2 Cilo² Black Urethane Arms (308 / 311 Chairs Only)..... No Charge

NOTE: Cilo² Is A Redesign Of Our Original Cilo Executive Collection Released in 2013. Although Cilo² Has New Style Numbers And A New Design, The Original Cilo Is Still Available Upon Request. Please Contact Customer Service For More Information.

Base & Caster Options Available (See Cilo² Options Pages)

| EXECUTIVE | | ITEM #: | SPECIFICATIONS GRADES LIST PRICES: | | | | | | | | | | | | | |
|---|--|--------------|---|------------|----------|-------------------------|----------|----------|-----------------------|----------|----------|----------|----------|-----------|-----------|-----------|
| HIGH BACK / UPHOLSTERED ARM | | | Overall: 26"w 28"d 44.5"-47.25"h | | | Arm: 27"-29.75"h | | | COM: 3 yds. | | | | | | | |
| | | | Seat: 21.5"w 19.25"d 18"-21"h | | | Weight: 62 lbs. | | | COL: 54 sq.ft. | | | | | | | |
| | | | COM | COL | 1 | 2 | 3 | 4 | 5 | 6 | 7 | 8 | 9 | 10 | L1 | L2 |
|  | | 307-2 | 1447 | 1592 | 1519 | 1595 | 1670 | 1746 | 1821 | 1897 | 1973 | 2048 | 2124 | 2199 | 2366 | 2639 |
| | | | <i>High Profile Black Base / Tilt Swivel w/ Lock / Pneumatic Seat Height Adjustment / 350 lb. Weight Capacity</i> | | | | | | | | | | | | | |
|  | | 307-4 | 1499 | 1649 | 1569 | 1644 | 1720 | 1795 | 1871 | 1947 | 2022 | 2098 | 2173 | 2249 | 2416 | 2688 |
| | | | <i>High Profile Black Base / Knee Tilt Swivel w/ Infinite Lock / Pneumatic Seat Height Adjustment</i> | | | | | | | | | | | | | |
| HIGH BACK / ALUMINUM ARM | | | Overall: 26"w 28"d 44.5"-47.25"h | | | Arm: 27"-29.75"h | | | COM: 2.5 yds. | | | | | | | |
| | | | Seat: 21.5"w 19.25"d 18"-21"h | | | Weight: 62 lbs. | | | COL: 45 sq.ft. | | | | | | | |
| | | | COM | COL | 1 | 2 | 3 | 4 | 5 | 6 | 7 | 8 | 9 | 10 | L1 | L2 |
|  | | 308-2 | 1476 | 1623 | 1519 | 1581 | 1643 | 1704 | 1766 | 1828 | 1890 | 1952 | 2014 | 2076 | 2211 | 2434 |
| | | | <i>High Profile Black Base / Tilt Swivel w/ Lock / Pneumatic Seat Height Adjustment / 350 lb. Weight Capacity</i> | | | | | | | | | | | | | |
|  | | 308-4 | 1534 | 1687 | 1574 | 1636 | 1698 | 1759 | 1821 | 1883 | 1945 | 2007 | 2069 | 2131 | 2266 | 2489 |
| | | | <i>High Profile Black Base / Knee Tilt Swivel w/ Infinite Lock / Pneumatic Seat Height Adjustment</i> | | | | | | | | | | | | | |
| HIGH BACK / ARMLESS | | | Overall: 21.5"w 28"d 44.5"-47.25"h | | | Arm: n/a | | | COM: 2.5 yds. | | | | | | | |
| | | | Seat: 21.5"w 19.25"d 18"-21"h | | | Weight: 58 lbs. | | | COL: 45 sq.ft. | | | | | | | |
| | | | COM | COL | 1 | 2 | 3 | 4 | 5 | 6 | 7 | 8 | 9 | 10 | L1 | L2 |
|  | | 309-2 | 1259 | 1385 | 1301 | 1356 | 1411 | 1466 | 1521 | 1576 | 1631 | 1685 | 1740 | 1795 | 1926 | 2124 |
| | | | <i>High Profile Black Base / Tilt Swivel w/ Lock / Pneumatic Seat Height Adjustment / 350 lb. Weight Capacity</i> | | | | | | | | | | | | | |
|  | | 309-4 | 1312 | 1443 | 1350 | 1405 | 1460 | 1515 | 1570 | 1625 | 1680 | 1735 | 1790 | 1845 | 1975 | 2173 |
| | | | <i>High Profile Black Base / Knee Tilt Swivel w/ Infinite Lock / Pneumatic Seat Height Adjustment</i> | | | | | | | | | | | | | |
| MID-BACK / UPHOLSTERED ARM | | | Overall: 26"w 27.25"d 37.5"-40.25"h | | | Arm: 27"-29.75"h | | | COM: 2.25 yds. | | | | | | | |
| | | | Seat: 21.5"w 19.25"d 18"-21"h | | | Weight: 53 lbs. | | | COL: 41 sq.ft. | | | | | | | |
| | | | COM | COL | 1 | 2 | 3 | 4 | 5 | 6 | 7 | 8 | 9 | 10 | L1 | L2 |
|  | | 310-2 | 1323 | 1455 | 1333 | 1375 | 1416 | 1457 | 1498 | 1540 | 1581 | 1622 | 1663 | 1705 | 1826 | 1975 |
| | | | <i>High Profile Black Base / Tilt Swivel w/ Lock / Pneumatic Seat Height Adjustment / 350 lb. Weight Capacity</i> | | | | | | | | | | | | | |
|  | | 310-4 | 1364 | 1500 | 1377 | 1413 | 1454 | 1496 | 1537 | 1578 | 1619 | 1661 | 1702 | 1743 | 1865 | 2013 |
| | | | <i>High Profile Black Base / Knee Tilt Swivel w/ Infinite Lock / Pneumatic Seat Height Adjustment</i> | | | | | | | | | | | | | |

DESCRIPTION:





- Upholstery Frames: Curved Plywood & Hardwood
- Seat / Back: High Density Polyurethane Foam
- Aluminum Arms: Polished Cast Aluminum Arm Fitted w/ Black Rigid Polyurethane Arm Insert
- 10 Year Warranty

OPTIONS:





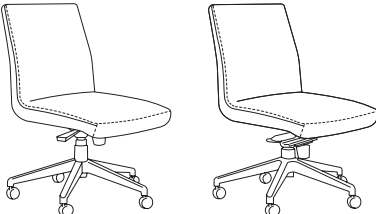

- Polished Aluminum Base / Tilt Swivel w/ Lock / Pneumatic Seat Height Adj.....\$120
- Note: For All (-2) Item Numbers**
- Polished Aluminum Base / Knee Tilt Swivel / Pneumatic Seat Height Adj.....\$120
- Note: For All (-4) Item Numbers**
- UA1 Cilo² Upholstered Arms (308 / 311 Chairs Only)..... Call For Pricing
- UA2 Cilo² Black Urethane Arms (308 / 311 Chairs Only)..... No Charge





NOTE: Cilo² Is A Redesign Of Our Original Cilo Executive Collection Released in 2013. Although Cilo² Has New Style Numbers And A New Design, The Original Cilo Is Still Available Upon Request. Please Contact Customer Service For More Information.

Base & Caster Options Available (See Cilo² Options Pages)

| EXECUTIVE | | ITEM #: | SPECIFICATIONS GRADES LIST PRICES: | | | | | | | | | | | | | |
|---|--|--------------|--|------------|----------|-------------------------|----------|----------|-----------------------|----------|----------|----------|----------|-----------|-----------|-----------|
| MID-BACK / UPHOLSTERED ARM JURY CHAIR | | | Overall: 26"w 27.25"d 37.5"-40.25"h | | | Arm: 27"-29.75"h | | | COM: 2.25 yds. | | | | | | | |
|  | | | Seat: 21.5"w 19.25"d 18"-21"h | | | Weight: 53 lbs. | | | COL: 41 sq.ft. | | | | | | | |
| | | 310-5 | COM | COL | 1 | 2 | 3 | 4 | 5 | 6 | 7 | 8 | 9 | 10 | L1 | L2 |
| | | | 1451 | 1596 | 1465 | 1496 | 1537 | 1578 | 1619 | 1661 | 1702 | 1743 | 1784 | 1825 | 1947 | 2096 |
| <i>Black Jury Base / Tilt Swivel w/ Lock / Pneumatic Seat Height Adjustment / 360° Self-Centering / 350 lb. Weight Capacity</i> | | | | | | | | | | | | | | | | |
| MID-BACK / ALUMINUM ARM | | | Overall: 26"w 27.25"d 37.5"-40.25"h | | | Arm: 27"-29.75"h | | | COM: 1.75 yds. | | | | | | | |
|  | | | Seat: 21.5"w 19.25"d 18"-21"h | | | Weight: 53 lbs. | | | COL: 32 sq.ft. | | | | | | | |
| | | 311-2 | COM | COL | 1 | 2 | 3 | 4 | 5 | 6 | 7 | 8 | 9 | 10 | L1 | L2 |
| | | | 1358 | 1493 | 1366 | 1407 | 1449 | 1490 | 1531 | 1572 | 1614 | 1655 | 1696 | 1737 | 1841 | 1990 |
| <i>High Profile Black Base / Tilt Swivel w/ Lock / Pneumatic Seat Height Adjustment / 350 lb. Weight Capacity</i> | | | | | | | | | | | | | | | | |
| | | 311-4 | COM | COL | 1 | 2 | 3 | 4 | 5 | 6 | 7 | 8 | 9 | 10 | L1 | L2 |
| | | | 1416 | 1557 | 1427 | 1462 | 1504 | 1545 | 1586 | 1627 | 1668 | 1710 | 1751 | 1792 | 1896 | 2045 |
| <i>High Profile Black Base / Knee Tilt Swivel w/ Infinite Lock / Pneumatic Seat Height Adjustment / 350 lb. Weight Capacity</i> | | | | | | | | | | | | | | | | |
| MID-BACK / ALUMINUM ARM JURY CHAIR | | | Overall: 26"w 27.25"d 37.5"-40.25"h | | | Arm: 27"-29.75"h | | | COM: 1.75 yds. | | | | | | | |
|  | | | Seat: 21.5"w 19.25"d 18"-21"h | | | Weight: 53 lbs. | | | COL: 32 sq.ft. | | | | | | | |
| | | 311-5 | COM | COL | 1 | 2 | 3 | 4 | 5 | 6 | 7 | 8 | 9 | 10 | L1 | L2 |
| | | | 1544 | 1698 | 1553 | 1583 | 1625 | 1666 | 1707 | 1748 | 1789 | 1831 | 1872 | 1913 | 2017 | 2166 |
| <i>Black Jury Base / Tilt Swivel w/ Lock / Pneumatic Seat Height Adjustment / 360° Self-Centering / 350 lb. Weight Capacity</i> | | | | | | | | | | | | | | | | |
| MID-BACK / ARMLESS | | | Overall: 21.5"w 27.25"d 37.5"-40.25"h | | | Arm: n/a | | | COM: 1.75 yds. | | | | | | | |
|  | | | Seat: 21.5"w 19.25"d 18"-21"h | | | Weight: 49 lbs. | | | COL: 32 sq.ft. | | | | | | | |
| | | 312-2 | COM | COL | 1 | 2 | 3 | 4 | 5 | 6 | 7 | 8 | 9 | 10 | L1 | L2 |
| | | | 1150 | 1264 | 1169 | 1211 | 1252 | 1293 | 1334 | 1375 | 1417 | 1458 | 1499 | 1540 | 1644 | 1793 |
| <i>High Profile Black Base / Tilt Swivel w/ Lock / Pneumatic Seat Height Adjustment / 350 lb. Weight Capacity</i> | | | | | | | | | | | | | | | | |
| | | 312-4 | COM | COL | 1 | 2 | 3 | 4 | 5 | 6 | 7 | 8 | 9 | 10 | L1 | L2 |
| | | | 1196 | 1316 | 1219 | 1255 | 1296 | 1337 | 1378 | 1419 | 1461 | 1502 | 1543 | 1584 | 1688 | 1837 |
| <i>High Profile Black Base / Knee Tilt Swivel w/ Infinite Lock / Pneumatic Seat Height Adjustment / 350 lb. Weight Capacity</i> | | | | | | | | | | | | | | | | |
| MID-BACK / ARMLESS JURY CHAIR | | | Overall: 21.5"w 27.25"d 37.5"-40.25"h | | | Arm: n/a | | | COM: 1.75 yds. | | | | | | | |
|  | | | Seat: 21.5"w 19.25"d 18"-21"h | | | Weight: 49 lbs. | | | COL: 32 sq.ft. | | | | | | | |
| | | 312-5 | COM | COL | 1 | 2 | 3 | 4 | 5 | 6 | 7 | 8 | 9 | 10 | L1 | L2 |
| | | | 1330 | 1463 | 1351 | 1381 | 1422 | 1463 | 1505 | 1546 | 1587 | 1628 | 1670 | 1711 | 1815 | 1963 |
| <i>Black Jury Base / Tilt Swivel w/ Lock / Pneumatic Seat Height Adjustment / 360° Self-Centering / 350 lb. Weight Capacity</i> | | | | | | | | | | | | | | | | |

| BASES | OPTION #: | SPECIFICATIONS LIST PRICES AVAILABILITY: |
|--|-----------|---|
| <p data-bbox="94 176 329 205">TRANSITIONAL WOOD BASE</p>  | TWB | <p data-bbox="581 176 781 205">Overall: 25"w 25"d 5.5"h</p> <hr/> <p data-bbox="581 268 630 298">\$237</p> <p data-bbox="581 298 1208 323"><i>Solid Hardwood Cap, Steel Reinforced 5 Prong Base With 55mm Black Dual Wheel Casters.</i></p> <p data-bbox="581 344 1230 415"> OPTIONS: C1 Carpet Caster - 2" Metal Balls \$200 (Set Of 5) C2 Antique Bronze Hooded Caster - 2" Rubber Ball \$152 (Set Of 5) C3 Brass Hooded Black Caster - 2" Dual Wheels \$95 (Set Of 5) </p> <p data-bbox="581 464 834 489">Available: <i>Cilo² Executive Seating</i></p> |
| <p data-bbox="94 638 280 667">CLASSIC WOOD BASE</p>  | CWB | <p data-bbox="581 638 768 667">Overall: 28"w 28"d 5"h</p> <hr/> <p data-bbox="581 730 630 760">\$237</p> <p data-bbox="581 760 1208 785"><i>Solid Hardwood Cap, Steel Reinforced 5 Prong Base With 55mm Black Dual Wheel Casters.</i></p> <p data-bbox="581 806 1230 903"> OPTIONS: C1 Carpet Caster - 2" Metal Balls \$200 (Set Of 5) C2 Antique Bronze Hooded Caster - 2" Rubber Ball \$152 (Set Of 5) C3 Brass Hooded Black Caster - 2" Dual Wheels \$95 (Set Of 5) SP Brass Scuff Plates \$121 (Set Of 5) </p> <p data-bbox="581 951 834 976">Available: <i>Cilo² Executive Seating</i></p> |
| <p data-bbox="94 1100 277 1129">ARCHED RESIN BASE</p>  | ARB | <p data-bbox="581 1100 789 1129">Overall: 27"w 27"d 6.25"h</p> <hr/> <p data-bbox="581 1192 675 1222">No Charge</p> <p data-bbox="581 1222 1105 1247"><i>Black Reinforced Nylon 5 Prong Base With 55mm Black Dual Wheel Casters.</i></p> <p data-bbox="581 1268 1182 1293"> OPTIONS: C4 Black Sculptured Glides No Upcharge </p> <p data-bbox="581 1341 834 1367">Available: <i>Cilo² Executive Seating</i></p> |
| <p data-bbox="94 1562 329 1591">POLISHED ALUMINUM BASE</p>  | PAB | <p data-bbox="581 1562 768 1591">Overall: 26"w 26"d 8"h</p> <hr/> <p data-bbox="581 1654 630 1684">\$120</p> <p data-bbox="581 1684 1073 1709"><i>Polished Aluminum 5 Prong Base With 55mm Black Dual Wheel Casters</i></p> <p data-bbox="581 1730 1235 1785"> OPTIONS: C4 Black Sculptured Glides No Upcharge (Set Of 5) C5 Polished Aluminum Hooded Casters \$105 (Set Of 5) </p> <p data-bbox="581 1829 834 1854">Available: <i>Cilo² Executive Seating</i></p> |

| BASES / CASTERS | OPTION #: | SPECIFICATIONS LIST PRICES AVAILABILITY: |
|---|--|--|
| <p>HIGH PROFILE BASE</p>  | <p>HPB</p> | <p>Overall: 26"w 26"d 8"h</p> <hr/> <p>Standard CILO Base - No Charge <i>Black Reinforced Nylon 5 Prong Base With 55mm Black Dual Wheel Casters</i></p> <p>Available: Cilo² Executive Seating</p> |
| <p>JURY BASE</p>  | <p>JRB</p> | <p>Overall: 8.5" Diameter 3.75"h</p> <hr/> <p>\$200 <i>360° Rotation, Self Centering With Pneumatic Height Adjustment</i></p> <p>OPTIONS: No Rotation</p> <p>Available: Cilo² Executive Seating</p> |
| <p>CASTERS</p> <div style="display: flex; flex-wrap: wrap;"> <div style="width: 50%;">  <p>(C1) Carpet Caster - 2" Metal Balls</p> </div> <div style="width: 50%;">  <p>(C2) Antique Bronze Hooded Caster - 2" Rubber Ball</p> </div> <div style="width: 50%;">  <p>(C3) Brass Hooded Black Caster - 2" Dual Wheels</p> </div> <div style="width: 50%;">  <p>(C4) Black Sculptured Glide - 2" Flat Bottom Glide</p> </div> <div style="width: 50%;">  <p>(C5) Polished Aluminum Caster - 2" Dual Wheels</p> </div> </div> | <p>C1</p> <p>C2</p> <p>C3</p> <p>C4</p> <p>C5</p> | <p>Overall: 2"h</p> <hr/> <p>\$200 (Set Of 5) <i>Carpet Caster - 2" Metal Balls - Antique Windsor (Additional Finishes Available)</i></p> <p>\$152 (Set Of 5) <i>Antique Bronze Hooded Caster - 2" Rubber Ball (Additional Finishes Available)</i></p> <p>\$95 (Set Of 5) <i>Brass Hooded Black Caster - 2" Dual Wheels (Additional Finishes Available)</i></p> <p>No Charge (Set Of 5) <i>Black Sculptured Glide - 2" Flat Bottom Glide</i></p> <p>\$105 (Set Of 5) <i>Polished Aluminum Hooded Caster - 2" Dual Wheels</i></p> <p>Available: Cilo² Executive Seating</p> |

| SCUFF PLATES / ARMS / COVERS OPTION #: | SPECIFICATIONS LIST PRICES AVAILABILITY: |
|--|--|
| <p data-bbox="87 178 224 205">SCUFF PLATES</p>  | <p data-bbox="570 178 716 205">Overall: 1"w 4"d</p> <hr/> <p data-bbox="521 268 553 296">SP</p> <p data-bbox="570 268 764 323">\$121 (Set Of 5) (Specify Brass Or Pewter)</p> <p data-bbox="570 365 846 392">Available: Classic Wood Base Only</p> |
| <p data-bbox="87 640 277 667">UPHOLSTERED ARMS</p>  | <p data-bbox="570 640 789 667">Overall: 2.75"w 11"d 13"h</p> <hr/> <p data-bbox="509 730 553 758">UA1</p> <p data-bbox="570 730 773 785">Call For Pricing (Specify Fabric Or Leather)</p> <p data-bbox="570 827 992 854">Available: Cilo² Executive Chairs (308 / 311 Chairs Only)</p> |
| <p data-bbox="87 1102 305 1129">BLACK URETHANE ARMS</p>  | <p data-bbox="570 1102 781 1129">Overall: 2"w 11.5"d 15"h</p> <hr/> <p data-bbox="509 1192 553 1220">UA2</p> <p data-bbox="570 1192 984 1247">No Charge Black Urethane Arms Replace Metal Arms At No Upcharge.</p> <p data-bbox="570 1289 992 1316">Available: Cilo² Executive Chairs (308 / 311 Chairs Only)</p> |
| <p data-bbox="87 1564 293 1591">CONTRASTING COVERS</p>  | <p data-bbox="570 1564 678 1591">Overall: n/a</p> <hr/> <p data-bbox="521 1654 553 1682">CC</p> <p data-bbox="570 1654 1479 1759">\$129 <i>NOTE: If Two Or More Upholsteries Or Leathers Are Used On Any Piece Of Furniture, Then A Contrast Charge Will Apply Per Order. When Using Trinity Upholstery, The Higher Priced Upholstery Grade Will Be Used In Pricing, Unless It's Trinity Leather With Fabric Contrast Welt, Or COM With Trinity Contrast Welt, Then Contact Customer Service For Pricing.</i></p> <p data-bbox="570 1801 829 1829">Available: Cilo² Executive Chairs</p> |

Ziggy

GUEST SEATING

Effective: March 1, 2025

T R I N I T Y

Date:

Page:

Modification:







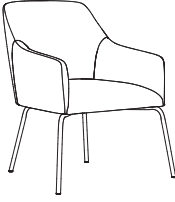
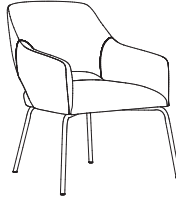

Description:

DESCRIPTION:

- Upholstery Frames: Plywood & Hardwood
- Seat: High Density Polyurethane Foam Over Plywood
- Back: High Density Foam Over Plywood Frame
- (5) Base Styles Available
- 10 Year Warranty

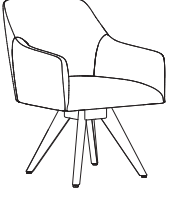
OPTIONS:

Feather Down & Polyester Pillows Available (See Page 5)
Specify Exposed Wood Finish (See Page 6)

| GUEST | | ITEM #: | SPECIFICATIONS GRADES LIST PRICES: | | | | | | | | | | | | | |
|--|---|--------------|--|------|------|------------------------|------|------|-----------------------|------|------|------|------|------|------|------|
| BUCKET GUEST CHAIR / CLOSED & OPEN BACK | | | Overall: 25.5"w 27.75"d 35"h | | | Arm: 26"h | | | COM: 4 yds. | | | | | | | |
| | | | Seat: 20"w 20"d 19"h | | | Weight: 55 lbs. | | | COL: 72 sq.ft. | | | | | | | |
|  |  | 330-A | COM | COL | 1 | 2 | 3 | 4 | 5 | 6 | 7 | 8 | 9 | 10 | L1 | L2 |
| | | | 1355 | 1490 | 1497 | 1605 | 1714 | 1822 | 1930 | 2038 | 2147 | 2255 | 2363 | 2471 | 2592 | 2981 |
| | | | <i>Tight Seat & Closed Back / 4 Leg - Black Steel Base / 350 lb. Weight Capacity</i> | | | | | | | | | | | | | |
| | | 331-A | 1437 | 1580 | 1575 | 1683 | 1791 | 1899 | 2008 | 2116 | 2224 | 2332 | 2441 | 2549 | 2680 | 3070 |
| | | | <i>Tight Seat & Open Back / 4 Leg - Black Steel Base / 350 lb. Weight Capacity</i> | | | | | | | | | | | | | |
| 330-A Closed Back | | | | | | | | | | | | | | | | |
| 331-A Open Back | | | | | | | | | | | | | | | | |
| BUCKET GUEST CHAIR / CLOSED & OPEN BACK | | | Overall: 25.5"w 27.75"d 35"h | | | Arm: 26"h | | | COM: 4 yds. | | | | | | | |
| | | | Seat: 20"w 20"d 19"h | | | Weight: 55 lbs. | | | COL: 72 sq.ft. | | | | | | | |
|  |  | 330-B | COM | COL | 1 | 2 | 3 | 4 | 5 | 6 | 7 | 8 | 9 | 10 | L1 | L2 |
| | | | 1208 | 1329 | 1359 | 1467 | 1575 | 1683 | 1792 | 1900 | 2008 | 2116 | 2225 | 2333 | 2453 | 2843 |
| | | | <i>Tight Seat & Closed Back / 4 Leg - Flat Polished Base / 360° Swivel & Seat Height Adjustment / 350 lb. Weight Capacity</i> | | | | | | | | | | | | | |
| | | 331-B | 1290 | 1419 | 1436 | 1544 | 1653 | 1761 | 1869 | 1977 | 2086 | 2194 | 2302 | 2410 | 2542 | 2931 |
| | | | <i>Tight Seat & Open Back / 4 Leg - Flat Polished Base / 360° Swivel & Seat Height Adjustment / 350 lb. Weight Capacity</i> | | | | | | | | | | | | | |
| 330-B Closed Back | | | | | | | | | | | | | | | | |
| 331-B Open Back | | | | | | | | | | | | | | | | |
| BUCKET GUEST CHAIR / CLOSED & OPEN BACK | | | Overall: 25.5"w 27.75"d 35"h | | | Arm: 26"h | | | COM: 4 yds. | | | | | | | |
| | | | Seat: 20"w 20"d 19"h | | | Weight: 55 lbs. | | | COL: 72 sq.ft. | | | | | | | |
|  |  | 330-C | COM | COL | 1 | 2 | 3 | 4 | 5 | 6 | 7 | 8 | 9 | 10 | L1 | L2 |
| | | | 1342 | 1477 | 1486 | 1594 | 1702 | 1810 | 1919 | 2027 | 2135 | 2243 | 2352 | 2460 | 2580 | 2970 |
| | | | <i>Tight Seat & Closed Back / 4 Leg - Raised Polished Base / 360° Swivel Only - No Seat Height Adjustment / 350 lb. Weight Capacity</i> | | | | | | | | | | | | | |
| | | 331-C | 1424 | 1567 | 1563 | 1671 | 1780 | 1888 | 1996 | 2104 | 2213 | 2321 | 2429 | 2537 | 2669 | 3058 |
| | | | <i>Tight Seat & Open Back / 4 Leg - Raised Polished Base / 360° Swivel Only - No Seat Height Adjustment / 350 lb. Weight Capacity</i> | | | | | | | | | | | | | |
| 330-C Closed Back | | | | | | | | | | | | | | | | |
| 331-C Open Back | | | | | | | | | | | | | | | | |
| BUCKET GUEST CHAIR / CLOSED & OPEN BACK | | | Overall: 25.5"w 27.75"d 35"h | | | Arm: 26"h | | | COM: 4 yds. | | | | | | | |
| | | | Seat: 20"w 20"d 19"h | | | Weight: 55 lbs. | | | COL: 72 sq.ft. | | | | | | | |
|  |  | 330-D | COM | COL | 1 | 2 | 3 | 4 | 5 | 6 | 7 | 8 | 9 | 10 | L1 | L2 |
| | | | 1246 | 1371 | 1395 | 1503 | 1611 | 1720 | 1828 | 1936 | 2044 | 2153 | 2261 | 2369 | 2490 | 2879 |
| | | | <i>Tight Seat & Closed Back / 4 Leg - Wood Base / 350 lb. Weight Capacity</i> | | | | | | | | | | | | | |
| | | 331-D | 1377 | 1515 | 1519 | 1627 | 1735 | 1843 | 1952 | 2060 | 2168 | 2276 | 2385 | 2493 | 2624 | 3014 |
| | | | <i>Tight Seat & Open Back / 4 Leg - Wood Base / 350 lb. Weight Capacity</i> | | | | | | | | | | | | | |
| 330-D Closed Back | | | | | | | | | | | | | | | | |
| 331-D Open Back | | | | | | | | | | | | | | | | |
| BUCKET GUEST CHAIR / CLOSED & OPEN BACK | | | Overall: 25.5"w 27.75"d 35"h | | | Arm: 26"h | | | COM: 4 yds. | | | | | | | |
| | | | Seat: 20"w 20"d 19"h | | | Weight: 55 lbs. | | | COL: 72 sq.ft. | | | | | | | |
|  |  | 330-E | COM | COL | 1 | 2 | 3 | 4 | 5 | 6 | 7 | 8 | 9 | 10 | L1 | L2 |
| | | | 1196 | 1315 | 1347 | 1455 | 1564 | 1672 | 1780 | 1888 | 1996 | 2105 | 2213 | 2321 | 2442 | 2831 |
| | | | <i>Tilt Swivel / Pneumatic Seat Height Adjustment / Polished Five Star Base w/ 55mm Black Dual Wheel Casters / Tight Seat & Closed Back / 350 lb. Wt. Capacity</i> | | | | | | | | | | | | | |
| | | 331-E | 1284 | 1412 | 1430 | 1539 | 1647 | 1755 | 1863 | 1972 | 2080 | 2188 | 2296 | 2405 | 2536 | 2926 |
| | | | <i>Tilt Swivel / Pneumatic Seat Height Adjustment / Polished Five Star Base w/ 55mm Black Dual Wheel Casters / Tight Seat & Open Back / 350 lb. Wt. Capacity</i> | | | | | | | | | | | | | |
| 330-E Closed Back | | | | | | | | | | | | | | | | |
| 331-E Open Back | | | | | | | | | | | | | | | | |

| CONTRASTING COVERS | OPTION #: | SPECIFICATIONS LIST PRICES AVAILABILITY: |
|---|--|--|
| <p>CONTRASTING COVERS</p>  | <p>Overall: n/a</p> <hr/> <p>CC \$129 <i>NOTE: If Two Or More Upholsteries Or Leathers Are Used On Any Piece Of Furniture, Then A Contrast Charge Will Apply Per Order. When Using Trinity Upholstery, The Higher Priced Upholstery Grade Will Be Used In Pricing, Unless It's Trinity Leather With Fabric Contrast Welt, Or COM With Trinity Contrast Welt, Then Contact Customer Service For Pricing.</i></p> <p>Available: Ziggy Collection</p> | |

Vroom

GUEST SEATING / TABLES

Effective: March 1, 2025

T R I N I T Y

Date:

Page:

Modification:





Description:

DESCRIPTION:

- Upholstery Frames: Molded Foam Over Steel
- Seat: Molded Foam Over Plywood
- Back: Molded Foam Over Steel
- (4) Base Styles Available
- 10 Year Warranty

OPTIONS:

Feather Down & Polyester Pillows Available (See Page 5)
Specify Exposed Wood Finish / Laminate (See Page 6)



| GUEST | ITEM #: | SPECIFICATIONS GRADES LIST PRICES: | | | | | | | | | | | | | |
|--|---------|--|------|---|------|------|--|------|------|------|------|------|------|------|------|
| <p>HIGH BACK GUEST CHAIR</p>  | 332-B | <p>Overall: 25.25"w 26.25"d 37.5"h</p> <p>Seat: 19.25"w 18.25"d 19"h</p> | | <p>Arm: 25"h</p> <p>Weight: 50 lbs.</p> | | | <p>COM: 4 yds.</p> <p>COL: 72 sq.ft.</p> | | | | | | | | |
| | | COM | COL | 1 | 2 | 3 | 4 | 5 | 6 | 7 | 8 | 9 | 10 | L1 | L2 |
| | | 1472 | 1619 | 1598 | 1701 | 1804 | 1907 | 2010 | 2113 | 2216 | 2319 | 2422 | 2525 | 2641 | 3012 |
| <p><i>Tight Seat & Back / 4 Leg - Flat Polished Base / 360° Swivel & Seat Height Adjustment / 350 lb. Weight Capacity</i></p> | | | | | | | | | | | | | | | |
| <p>HIGH BACK GUEST CHAIR</p>  | 332-C | <p>Overall: 25.25"w 26.25"d 37.5"h</p> <p>Seat: 19.25"w 18.25"d 19"h</p> | | <p>Arm: 25"h</p> <p>Weight: 50 lbs.</p> | | | <p>COM: 4 yds.</p> <p>COL: 72 sq.ft.</p> | | | | | | | | |
| | | COM | COL | 1 | 2 | 3 | 4 | 5 | 6 | 7 | 8 | 9 | 10 | L1 | L2 |
| | | 1588 | 1747 | 1708 | 1811 | 1914 | 2017 | 2120 | 2223 | 2326 | 2429 | 2532 | 2635 | 2751 | 3122 |
| <p><i>Tight Seat & Back / 4 Leg - Raised Polished Base / 360° Swivel Only - No Seat Height Adjustment / 350 lb. Weight Capacity</i></p> | | | | | | | | | | | | | | | |
| <p>HIGH BACK GUEST CHAIR</p>  | 332-D | <p>Overall: 25.25"w 26.25"d 37.5"h</p> <p>Seat: 19.25"w 18.25"d 19"h</p> | | <p>Arm: 25"h</p> <p>Weight: 48 lbs.</p> | | | <p>COM: 4 yds.</p> <p>COL: 72 sq.ft.</p> | | | | | | | | |
| | | COM | COL | 1 | 2 | 3 | 4 | 5 | 6 | 7 | 8 | 9 | 10 | L1 | L2 |
| | | 1409 | 1550 | 1539 | 1642 | 1745 | 1848 | 1951 | 2054 | 2157 | 2260 | 2363 | 2467 | 2582 | 2953 |
| <p><i>Tight Seat & Back / 4 Leg - Wood Base / 350 lb. Weight Capacity</i></p> | | | | | | | | | | | | | | | |
| <p>HIGH BACK GUEST CHAIR</p>  | 332-E | <p>Overall: 25.25"w 26.25"d 37.5"h</p> <p>Seat: 19.25"w 18.25"d 19"h</p> | | <p>Arm: 25"h</p> <p>Weight: 50 lbs.</p> | | | <p>COM: 4 yds.</p> <p>COL: 72 sq.ft.</p> | | | | | | | | |
| | | COM | COL | 1 | 2 | 3 | 4 | 5 | 6 | 7 | 8 | 9 | 10 | L1 | L2 |
| | | 1385 | 1523 | 1515 | 1618 | 1721 | 1824 | 1928 | 2031 | 2134 | 2237 | 2340 | 2443 | 2558 | 2929 |
| <p><i>Tilt Swivel / Pneumatic Seat Height Adjustment / Polished Five Star Base w/ 55mm Black Dual Wheel Casters / Tight Seat & Back / 350 lb. Wt. Capacity</i></p> | | | | | | | | | | | | | | | |

DESCRIPTION:

- Table Top: High Pressure Laminate Top Over Plywood Core w/ Exposed Plywood Edge
- (3) Base Styles Available
- 10 Year Warranty

OPTIONS:

SE24D Self Edge Table Top - 24" Diameter.....\$38
 Specify Exposed Wood Finish / Laminate (See Page 6)



| END TABLES | | ITEM #: | SPECIFICATIONS GRADES LIST PRICES: | | | | | | | | | | | | | | | | | | | | | | | | | | |
|--|------------|--|--|-----|---|---|---|---|---|---|----|----|----|----|----|----|--|--|--|--|--|--|--|--|--|--|--|--|--|
| ROUND END TABLE WITH FLAT POLISHED BASE  | 324D22-B-L | Overall: 24" Diameter 22"h Weight: 30 lbs. | | | | | | | | | | | | | | | | | | | | | | | | | | | |
| | | <table border="1"> <thead> <tr> <th>COM</th> <th>COL</th> <th>1</th> <th>2</th> <th>3</th> <th>4</th> <th>5</th> <th>6</th> <th>7</th> <th>8</th> <th>9</th> <th>10</th> <th>L1</th> <th>L2</th> </tr> </thead> <tbody> <tr> <td></td> <td></td> <td></td> <td></td> <td></td> <td></td> <td></td> <td></td> <td></td> <td></td> <td></td> <td></td> <td></td> <td></td> </tr> </tbody> </table> | COM | COL | 1 | 2 | 3 | 4 | 5 | 6 | 7 | 8 | 9 | 10 | L1 | L2 | | | | | | | | | | | | | |
| COM | COL | 1 | 2 | 3 | 4 | 5 | 6 | 7 | 8 | 9 | 10 | L1 | L2 | | | | | | | | | | | | | | | | |
| | | | | | | | | | | | | | | | | | | | | | | | | | | | | | |
| ROUND END TABLE WITH RAISED POLISHED BASE  | 324D22-C-L | Overall: 24" Diameter 22"h Weight: 30 lbs. | | | | | | | | | | | | | | | | | | | | | | | | | | | |
| | | <table border="1"> <thead> <tr> <th>COM</th> <th>COL</th> <th>1</th> <th>2</th> <th>3</th> <th>4</th> <th>5</th> <th>6</th> <th>7</th> <th>8</th> <th>9</th> <th>10</th> <th>L1</th> <th>L2</th> </tr> </thead> <tbody> <tr> <td></td> <td></td> <td></td> <td></td> <td></td> <td></td> <td></td> <td></td> <td></td> <td></td> <td></td> <td></td> <td></td> <td></td> </tr> </tbody> </table> | COM | COL | 1 | 2 | 3 | 4 | 5 | 6 | 7 | 8 | 9 | 10 | L1 | L2 | | | | | | | | | | | | | |
| COM | COL | 1 | 2 | 3 | 4 | 5 | 6 | 7 | 8 | 9 | 10 | L1 | L2 | | | | | | | | | | | | | | | | |
| | | | | | | | | | | | | | | | | | | | | | | | | | | | | | |
| ROUND END TABLE WITH WOOD BASE  | 324D22-D-L | Overall: 24" Diameter 22"h Weight: 30 lbs. | | | | | | | | | | | | | | | | | | | | | | | | | | | |
| | | <table border="1"> <thead> <tr> <th>COM</th> <th>COL</th> <th>1</th> <th>2</th> <th>3</th> <th>4</th> <th>5</th> <th>6</th> <th>7</th> <th>8</th> <th>9</th> <th>10</th> <th>L1</th> <th>L2</th> </tr> </thead> <tbody> <tr> <td></td> <td></td> <td></td> <td></td> <td></td> <td></td> <td></td> <td></td> <td></td> <td></td> <td></td> <td></td> <td></td> <td></td> </tr> </tbody> </table> | COM | COL | 1 | 2 | 3 | 4 | 5 | 6 | 7 | 8 | 9 | 10 | L1 | L2 | | | | | | | | | | | | | |
| COM | COL | 1 | 2 | 3 | 4 | 5 | 6 | 7 | 8 | 9 | 10 | L1 | L2 | | | | | | | | | | | | | | | | |
| | | | | | | | | | | | | | | | | | | | | | | | | | | | | | |

DESCRIPTION:

- Upholstery Frames: Molded Foam Over Steel
- Seat: Molded Foam Over Plywood
- Back: Molded Foam Over Steel
- (4) Base Styles Available
- 10 Year Warranty

OPTIONS:

SE24S Self Edge Table Top - 24" x 24" Square\$43
 Specify Exposed Wood Finish / Laminate (See Page 6)



| END TABLES | ITEM #: | SPECIFICATIONS GRADES LIST PRICES: | | | | | | | | | | | | | | | | | | | | | | | | | | | |
|---|--|--|-----|---|---|---|---|---|---|---|----|----|----|----|----|--|--|--|--|--|--|--|--|--|--|--|--|--|--|
| <p>SQUARE END TABLE WITH FLAT POLISHED BASE</p>  | <p>3242422-B-L</p> <p><i>Overall: 24"w 24"d 22"h</i> <i>Weight: 30 lbs.</i></p> <table border="1"> <thead> <tr> <th>COM</th> <th>COL</th> <th>1</th> <th>2</th> <th>3</th> <th>4</th> <th>5</th> <th>6</th> <th>7</th> <th>8</th> <th>9</th> <th>10</th> <th>L1</th> <th>L2</th> </tr> </thead> <tbody> <tr> <td></td> <td></td> <td></td> <td></td> <td></td> <td></td> <td></td> <td></td> <td></td> <td></td> <td></td> <td></td> <td></td> <td></td> </tr> </tbody> </table> <p>766 <i>High Pressure Laminate Top w/ Exposed Plywood Edge / 4 Leg - Flat Polished Base / No Swivel Or Height Adjustment</i></p> | COM | COL | 1 | 2 | 3 | 4 | 5 | 6 | 7 | 8 | 9 | 10 | L1 | L2 | | | | | | | | | | | | | | |
| COM | COL | 1 | 2 | 3 | 4 | 5 | 6 | 7 | 8 | 9 | 10 | L1 | L2 | | | | | | | | | | | | | | | | |
| | | | | | | | | | | | | | | | | | | | | | | | | | | | | | |
| <p>SQUARE END TABLE WITH RAISED POLISHED BASE</p>  | <p>3242422-C-L</p> <p><i>Overall: 24"w 24"d 22"h</i> <i>Weight: 30 lbs.</i></p> <table border="1"> <thead> <tr> <th>COM</th> <th>COL</th> <th>1</th> <th>2</th> <th>3</th> <th>4</th> <th>5</th> <th>6</th> <th>7</th> <th>8</th> <th>9</th> <th>10</th> <th>L1</th> <th>L2</th> </tr> </thead> <tbody> <tr> <td></td> <td></td> <td></td> <td></td> <td></td> <td></td> <td></td> <td></td> <td></td> <td></td> <td></td> <td></td> <td></td> <td></td> </tr> </tbody> </table> <p>741 <i>High Pressure Laminate Top w/ Exposed Plywood Edge / 4 Leg - Raised Polished Base / No Swivel Or Height Adjustment</i></p> | COM | COL | 1 | 2 | 3 | 4 | 5 | 6 | 7 | 8 | 9 | 10 | L1 | L2 | | | | | | | | | | | | | | |
| COM | COL | 1 | 2 | 3 | 4 | 5 | 6 | 7 | 8 | 9 | 10 | L1 | L2 | | | | | | | | | | | | | | | | |
| | | | | | | | | | | | | | | | | | | | | | | | | | | | | | |
| <p>SQUARE END TABLE WITH WOOD BASE</p>  | <p>3242422-D-L</p> <p><i>Overall: 24"w 24"d 22"h</i> <i>Weight: 30 lbs.</i></p> <table border="1"> <thead> <tr> <th>COM</th> <th>COL</th> <th>1</th> <th>2</th> <th>3</th> <th>4</th> <th>5</th> <th>6</th> <th>7</th> <th>8</th> <th>9</th> <th>10</th> <th>L1</th> <th>L2</th> </tr> </thead> <tbody> <tr> <td></td> <td></td> <td></td> <td></td> <td></td> <td></td> <td></td> <td></td> <td></td> <td></td> <td></td> <td></td> <td></td> <td></td> </tr> </tbody> </table> <p>707 <i>High Pressure Laminate Top w/ Exposed Plywood Edge / 4 Leg - Wood Base</i></p> | COM | COL | 1 | 2 | 3 | 4 | 5 | 6 | 7 | 8 | 9 | 10 | L1 | L2 | | | | | | | | | | | | | | |
| COM | COL | 1 | 2 | 3 | 4 | 5 | 6 | 7 | 8 | 9 | 10 | L1 | L2 | | | | | | | | | | | | | | | | |
| | | | | | | | | | | | | | | | | | | | | | | | | | | | | | |

DESCRIPTION:

- Upholstery Frames: Molded Foam Over Steel
- Seat: Molded Foam Over Plywood
- Back: Molded Foam Over Steel
- (4) Base Styles Available
- 10 Year Warranty

OPTIONS:

SE30D Self Edge Table Top - 30" Diameter.....\$38
 Specify Exposed Wood Finish / Laminate (See Page 6)



| COFFEE TABLES | | ITEM #: | SPECIFICATIONS GRADES LIST PRICES: | | | | | | | | | | | | | |
|--|------------|---|--|-----|---|---|---|---|---|---|---|---|---|----|----|----|
| <p>ROUND COFFEE TABLE WITH FLAT POLISHED BASE</p>  | 330D17-B-L | <p>Overall: 30" Diameter 17"h Weight: 30 lbs.</p> | COM | COL | 1 | 2 | 3 | 4 | 5 | 6 | 7 | 8 | 9 | 10 | L1 | L2 |
| | | 967 High Pressure Laminate Top w/ Exposed Plywood Edge / 4 Leg - Flat Polished Base / No Swivel Or Height Adjustment | | | | | | | | | | | | | | |
| <p>ROUND COFFEE TABLE WITH RAISED POLISHED BASE</p>  | 330D17-C-L | <p>Overall: 30" Diameter 17"h Weight: 30 lbs.</p> | COM | COL | 1 | 2 | 3 | 4 | 5 | 6 | 7 | 8 | 9 | 10 | L1 | L2 |
| | | 943 High Pressure Laminate Top w/ Exposed Plywood Edge / 4 Leg - Raised Polished Base / No Swivel Or Height Adjustment | | | | | | | | | | | | | | |
| <p>ROUND COFFEE TABLE WITH WOOD BASE</p>  | 330D17-D-L | <p>Overall: 30" Diameter 17"h Weight: 30 lbs.</p> | COM | COL | 1 | 2 | 3 | 4 | 5 | 6 | 7 | 8 | 9 | 10 | L1 | L2 |
| | | 869 High Pressure Laminate Top w/ Exposed Plywood Edge / 4 Leg - Wood Base | | | | | | | | | | | | | | |



DESCRIPTION:

- Upholstery Frames: Molded Foam Over Steel
- Seat: Molded Foam Over Plywood
- Back: Molded Foam Over Steel
- (4) Base Styles Available
- 10 Year Warranty

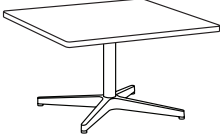
OPTIONS:

SE30S Self Edge Table Top - 30" x 30" Square\$43
 Specify Exposed Wood Finish / Laminate (See Page 6)

| COFFEE TABLES | | ITEM #: | SPECIFICATIONS GRADES LIST PRICES: | | | | | | | | | | | | | |
|---|-------------|---|--|-----|---|---|---|---|---|---|---|---|---|----|----|----|
| <p>SQUARE COFFEE TABLE WITH FLAT POLISHED BASE</p>  | 3303017-B-L | <p>Overall: 30"w 30"d 17"h Weight: 30 lbs.</p> | COM | COL | 1 | 2 | 3 | 4 | 5 | 6 | 7 | 8 | 9 | 10 | L1 | L2 |
| | | 943 High Pressure Laminate Top w/ Exposed Plywood Edge / 4 Leg - Flat Polished Base / No Swivel Or Height Adjustment | | | | | | | | | | | | | | |
| <p>SQUARE COFFEE TABLE WITH RAISED POLISHED BASE</p>  | 3303017-C-L | <p>Overall: 30"w 30"d 17"h Weight: 30 lbs.</p> | COM | COL | 1 | 2 | 3 | 4 | 5 | 6 | 7 | 8 | 9 | 10 | L1 | L2 |
| | | 918 High Pressure Laminate Top w/ Exposed Plywood Edge / 4 Leg - Raised Polished Base / No Swivel Or Height Adjustment | | | | | | | | | | | | | | |
| <p>SQUARE COFFEE TABLE WITH WOOD BASE</p>  | 3303017-D-L | <p>Overall: 30"w 30"d 17"h Weight: 30 lbs.</p> | COM | COL | 1 | 2 | 3 | 4 | 5 | 6 | 7 | 8 | 9 | 10 | L1 | L2 |
| | | 845 High Pressure Laminate Top w/ Exposed Plywood Edge / 4 Leg - Wood Base | | | | | | | | | | | | | | |

| CONTRASTING COVERS | OPTION #: | SPECIFICATIONS LIST PRICES AVAILABILITY: | | | | | | | | | | | | |
|--|--|--|-------|------------------------------------|------|-------|------------------------------------|------|-------|--|------|-------|--|------|
| <p>SELF EDGE TABLE TOP</p>  | | <p><i>Overall: 24" Diameter x 1" h / 24" w x 24" d x 1" h / 30" Diameter x 1" h / 30" w x 30" d x 1" h</i></p> <hr/> <table border="0"> <tr> <td data-bbox="570 268 618 300">SE24D</td> <td data-bbox="618 268 1057 300">Self Edge Table Top - 24" Diameter</td> <td data-bbox="1057 268 1534 300">\$38</td> </tr> <tr> <td data-bbox="570 317 618 348">SE30D</td> <td data-bbox="618 317 1057 348">Self Edge Table Top - 30" Diameter</td> <td data-bbox="1057 317 1534 348">\$38</td> </tr> <tr> <td data-bbox="570 365 618 396">SE24S</td> <td data-bbox="618 365 1057 396">Self Edge Table Top - 24" x 24" Square</td> <td data-bbox="1057 365 1534 396">\$43</td> </tr> <tr> <td data-bbox="570 413 618 445">SE30S</td> <td data-bbox="618 413 1057 445">Self Edge Table Top - 30" x 30" Square</td> <td data-bbox="1057 413 1534 445">\$43</td> </tr> </table> <p><i>High Pressure Laminate Top w/ Self Edge</i></p> <p>Available: Vroom Tables</p> | SE24D | Self Edge Table Top - 24" Diameter | \$38 | SE30D | Self Edge Table Top - 30" Diameter | \$38 | SE24S | Self Edge Table Top - 24" x 24" Square | \$43 | SE30S | Self Edge Table Top - 30" x 30" Square | \$43 |
| SE24D | Self Edge Table Top - 24" Diameter | \$38 | | | | | | | | | | | | |
| SE30D | Self Edge Table Top - 30" Diameter | \$38 | | | | | | | | | | | | |
| SE24S | Self Edge Table Top - 24" x 24" Square | \$43 | | | | | | | | | | | | |
| SE30S | Self Edge Table Top - 30" x 30" Square | \$43 | | | | | | | | | | | | |
| <p>CONTRASTING COVERS</p>  | | <p><i>Overall: n/a</i></p> <hr/> <p>CC \$129</p> <p><i>NOTE: If Two Or More Upholsteries Or Leathers Are Used On Any Piece Of Furniture, Then A Contrast Charge Will Apply Per Order. When Using Trinity Upholstery, The Higher Priced Upholstery Grade Will Be Used In Pricing, Unless It's Trinity Leather With Fabric Contrast Welt, Or COM With Trinity Contrast Welt, Then Contact Customer Service For Pricing.</i></p> <p>Available: Vroom Collection</p> | | | | | | | | | | | | |

Swerve

LOUNGE SEATING

Effective: March 1, 2025

T R I N I T Y

Date:

Page:

Modification:

Description:

DESCRIPTION:

- Upholstery Frames: Hardwood & Plywood
- Seat: High Density Foam Over Sheet Webbing
- Back: High Density Foam Over Plywood Frame
- 10 Year Warranty

OPTIONS:

Feather Down & Polyester Pillows Available (See Page 5)

NOTE: Trinity Must Approve Fabric Selection Before Ordering.

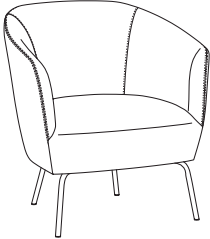
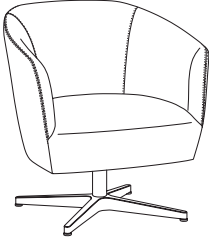
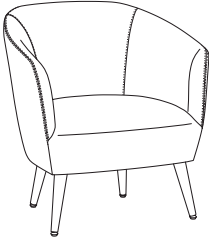
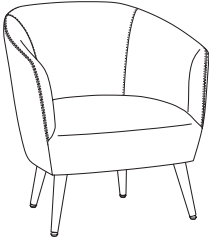
| LOUNGE | | ITEM #: | SPECIFICATIONS GRADES LIST PRICES: | | | | | | | | | | | | | |
|---|----------------------------------|---------|--|-----------------|------|-------------|----------------|------|-------------|------|------|------|------|------|------|------|
|  | LOUNGE CHAIR / FULLY UPHOLSTERED | 333-A | Overall: 30.75"w 27"d 30.75"h | | | Arm: 25.5"h | | | COM: 3 yds. | | | | | | | |
| | Seat: 23"w 19.5"d 18"h | | | Weight: 60 lbs. | | | COL: 54 sq.ft. | | | | | | | | | |
| | COM | | COL | 1 | 2 | 3 | 4 | 5 | 6 | 7 | 8 | 9 | 10 | L1 | L2 | |
| | | | 1332 | 1466 | 1401 | 1472 | 1543 | 1613 | 1684 | 1755 | 1825 | 1896 | 1967 | 2038 | 2141 | 2395 |
| | | | Tight Seat & Back / 4 Leg - Black Steel Base / 350 lb. Weight Capacity | | | | | | | | | | | | | |
|  | LOUNGE CHAIR / FULLY UPHOLSTERED | 333-B | Overall: 30.75"w 27"d 30.75"h | | | Arm: 25.5"h | | | COM: 3 yds. | | | | | | | |
| | Seat: 23"w 19.5"d 18"h | | | Weight: 60 lbs. | | | COL: 54 sq.ft. | | | | | | | | | |
| | COM | | COL | 1 | 2 | 3 | 4 | 5 | 6 | 7 | 8 | 9 | 10 | L1 | L2 | |
| | | | 1457 | 1603 | 1519 | 1590 | 1660 | 1731 | 1802 | 1873 | 1943 | 2014 | 2085 | 2155 | 2259 | 2513 |
| | | | Tight Seat & Back / 4 Leg - Flat Polished Base / 360° Swivel Only - No Height Adjustment / 350 lb. Weight Capacity | | | | | | | | | | | | | |
|  | LOUNGE CHAIR / FULLY UPHOLSTERED | 333-C | Overall: 30.75"w 27"d 30.75"h | | | Arm: 25.5"h | | | COM: 3 yds. | | | | | | | |
| | Seat: 23"w 19.5"d 18"h | | | Weight: 60 lbs. | | | COL: 54 sq.ft. | | | | | | | | | |
| | COM | | COL | 1 | 2 | 3 | 4 | 5 | 6 | 7 | 8 | 9 | 10 | L1 | L2 | |
| | | | 1632 | 1795 | 1684 | 1755 | 1825 | 1896 | 1967 | 2038 | 2108 | 2179 | 2250 | 2320 | 2424 | 2678 |
| | | | Tight Seat & Back / 4 Leg - Tapered Brushed Aluminum Metal Legs / 350 lb. Weight Capacity | | | | | | | | | | | | | |
|  | LOUNGE CHAIR / FULLY UPHOLSTERED | 333-D | Overall: 30.75"w 27"d 30.75"h | | | Arm: 25.5"h | | | COM: 3 yds. | | | | | | | |
| | Seat: 23"w 19.5"d 18"h | | | Weight: 55 lbs. | | | COL: 54 sq.ft. | | | | | | | | | |
| | COM | | COL | 1 | 2 | 3 | 4 | 5 | 6 | 7 | 8 | 9 | 10 | L1 | L2 | |
| | | | 1233 | 1356 | 1307 | 1378 | 1448 | 1519 | 1590 | 1660 | 1731 | 1802 | 1873 | 1943 | 2047 | 2301 |
| | | | Tight Seat & Back / 4 Leg - Tapered Wooden Legs / 350 lb. Weight Capacity | | | | | | | | | | | | | |

DESCRIPTION:

- Upholstery Frames: Hardwood & Plywood
- Seat: High Density Foam Over Sheet Webbing
- Back: High Density Foam Over Plywood Frame
- 10 Year Warranty

OPTIONS:

Feather Down & Polyester Pillows Available (See Page 5)

NOTE: Trinity Must Approve Fabric Selection Before Ordering.

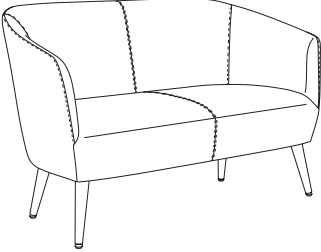
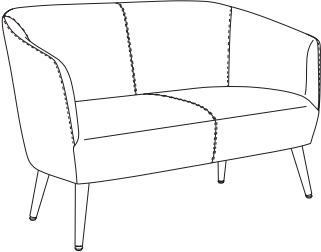
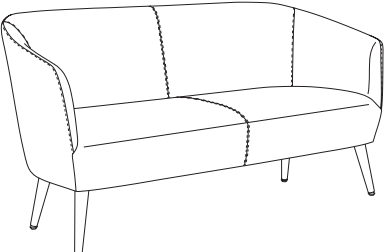
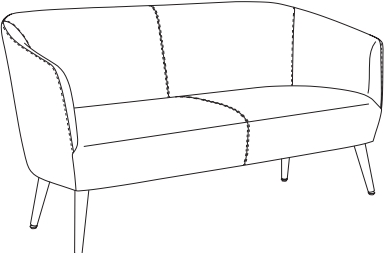
| LOUNGE | | ITEM #: | SPECIFICATIONS GRADES LIST PRICES: | | | | | | | | | | | | | |
|--|--------------------------------------|---------|---|------|------|------------------|------|------|------------------|------|------|------|------|------|------|------|
|  | TWO PLACE SOFA / FULLY UPHOLSTERED | 334-C | Overall: 53"w 27"d 30.75"h | | | Arm: 25.5"h | | | COM: 5.25 yds. | | | | | | | |
| | | | Seat: 45.25"w 19.5"d 18"h | | | Weight: 110 lbs. | | | COL: 94.5 sq.ft. | | | | | | | |
| | | | COM | COL | 1 | 2 | 3 | 4 | 5 | 6 | 7 | 8 | 9 | 10 | L1 | L2 |
| | | | 2820 | 3102 | 2921 | 3054 | 3188 | 3321 | 3455 | 3588 | 3721 | 3855 | 3988 | 4122 | 4329 | 4810 |
| | | | Tight Seat & Back / 4 Leg - Tapered Brushed Aluminum Legs / 500 lb. Weight Capacity | | | | | | | | | | | | | |
|  | TWO PLACE SOFA / FULLY UPHOLSTERED | 334-D | Overall: 53"w 27"d 30.75"h | | | Arm: 25.5"h | | | COM: 5.25 yds. | | | | | | | |
| | | | Seat: 45.25"w 19.5"d 18"h | | | Weight: 110 lbs. | | | COL: 94.5 sq.ft. | | | | | | | |
| | | | COM | COL | 1 | 2 | 3 | 4 | 5 | 6 | 7 | 8 | 9 | 10 | L1 | L2 |
| | | | 2313 | 2544 | 2441 | 2572 | 2703 | 2833 | 2964 | 3095 | 3226 | 3357 | 3488 | 3619 | 3822 | 4293 |
| | | | Tight Seat & Back / 4 Leg - Tapered Wooden Legs / 500 lb. Weight Capacity | | | | | | | | | | | | | |
|  | THREE PLACE SOFA / FULLY UPHOLSTERED | 335-C | Overall: 67"w 27"d 30.75"h | | | Arm: 25.5"h | | | COM: 6 yds. | | | | | | | |
| | | | Seat: 59.25"w 19.5"d 18"h | | | Weight: 165 lbs. | | | COL: 108 sq.ft. | | | | | | | |
| | | | COM | COL | 1 | 2 | 3 | 4 | 5 | 6 | 7 | 8 | 9 | 10 | L1 | L2 |
| | | | 3311 | 3642 | 3426 | 3584 | 3743 | 3902 | 4061 | 4219 | 4378 | 4537 | 4696 | 4854 | 5118 | 5690 |
| | | | Tight Seat & Back / 4 Leg - Tapered Brushed Aluminum Legs / 750 lb. Weight Capacity | | | | | | | | | | | | | |
|  | THREE PLACE SOFA / FULLY UPHOLSTERED | 335-D | Overall: 67"w 27"d 30.75"h | | | Arm: 25.5"h | | | COM: 6 yds. | | | | | | | |
| | | | Seat: 59.25"w 19.5"d 18"h | | | Weight: 165 lbs. | | | COL: 108 sq.ft. | | | | | | | |
| | | | COM | COL | 1 | 2 | 3 | 4 | 5 | 6 | 7 | 8 | 9 | 10 | L1 | L2 |
| | | | 2860 | 3146 | 3002 | 3161 | 3320 | 3479 | 3637 | 3796 | 3955 | 4114 | 4272 | 4431 | 4695 | 5266 |
| | | | Tight Seat & Back / 4 Leg - Tapered Wooden Legs / 750 lb. Weight Capacity | | | | | | | | | | | | | |

DESCRIPTION:

- Upholstery Frames: Hardwood & Plywood
- Seat: High Density Foam Over Sheet Webbing
- Back: High Density Foam Over Plywood Frame
- 10 Year Warranty

OPTIONS:

- ST1 Storage Cubby (#341 Chairs Only).....\$226
- Feather Down & Polyester Pillows Available (See Page 5)

NOTE: Trinity Must Approve Fabric Selection Before Ordering.

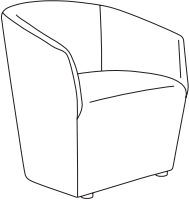
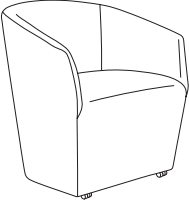
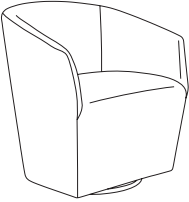
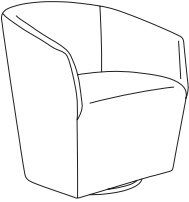
| LOUNGE | | ITEM #: | SPECIFICATIONS GRADES LIST PRICES: | | | | | | | | | | | | | |
|---|----------------------------------|---------|--|-----------------|------|-------------|------------------|------|----------------|------|------|------|------|------|------|------|
|  | LOUNGE CHAIR / FULLY UPHOLSTERED | 341-A | Overall: 30"w 24.5"d 31.5"h | | | Arm: 25.5"h | | | COM: 3.25 yds. | | | | | | | |
| | Seat: 24"w 19"d 18.5"h | | | Weight: 58 lbs. | | | COL: 58.5 sq.ft. | | | | | | | | | |
| | COM | | COL | 1 | 2 | 3 | 4 | 5 | 6 | 7 | 8 | 9 | 10 | L1 | L2 | |
| | | | 1048 | 1153 | 1132 | 1203 | 1274 | 1345 | 1415 | 1486 | 1557 | 1627 | 1698 | 1769 | 1872 | 2127 |
| Tight Seat & Back / Round Black Plastic Legs / 350 lb. Weight Capacity | | | | | | | | | | | | | | | | |
|  | LOUNGE CHAIR / FULLY UPHOLSTERED | 341-B | Overall: 30"w 24.5"d 31.5"h | | | Arm: 25.5"h | | | COM: 3.25 yds. | | | | | | | |
| | Seat: 24"w 19"d 18.5"h | | | Weight: 58 lbs. | | | COL: 58.5 sq.ft. | | | | | | | | | |
| | COM | | COL | 1 | 2 | 3 | 4 | 5 | 6 | 7 | 8 | 9 | 10 | L1 | L2 | |
| | | | 1048 | 1153 | 1132 | 1203 | 1274 | 1345 | 1415 | 1486 | 1557 | 1627 | 1698 | 1769 | 1872 | 2127 |
| Tight Seat & Back / Dual Wheel Casters / 350 lb. Weight Capacity | | | | | | | | | | | | | | | | |
|  | LOUNGE CHAIR / FULLY UPHOLSTERED | 341-C | Overall: 30"w 24.5"d 32"h | | | Arm: 26"h | | | COM: 3.25 yds. | | | | | | | |
| | Seat: 24"w 19"d 19"h | | | Weight: 58 lbs. | | | COL: 58.5 sq.ft. | | | | | | | | | |
| | COM | | COL | 1 | 2 | 3 | 4 | 5 | 6 | 7 | 8 | 9 | 10 | L1 | L2 | |
| | | | 1165 | 1282 | 1243 | 1314 | 1385 | 1455 | 1526 | 1597 | 1667 | 1738 | 1809 | 1880 | 1983 | 2237 |
| Tight Seat & Back / 360° Swivel Base / 350 lb. Weight Capacity | | | | | | | | | | | | | | | | |
|  | LOUNGE CHAIR / FULLY UPHOLSTERED | 341-D | Overall: 30"w 24.5"d 32"h | | | Arm: 26"h | | | COM: 3.25 yds. | | | | | | | |
| | Seat: 24"w 19"d 19"h | | | Weight: 58 lbs. | | | COL: 58.5 sq.ft. | | | | | | | | | |
| | COM | | COL | 1 | 2 | 3 | 4 | 5 | 6 | 7 | 8 | 9 | 10 | L1 | L2 | |
| | | | 1205 | 1326 | 1281 | 1352 | 1422 | 1493 | 1564 | 1634 | 1705 | 1776 | 1847 | 1917 | 2021 | 2275 |
| Tight Seat & Back / Self-Return 180° Swivel Base / 350 lb. Weight Capacity | | | | | | | | | | | | | | | | |

DESCRIPTION:



- Upholstery Frames: Hardwood & Plywood
- Seat: High Density Foam Over Sheet Webbing
- Back: High Density Foam Over Plywood Frame
- 10 Year Warranty

OPTIONS:

Feather Down & Polyester Pillows Available (See Page 5)

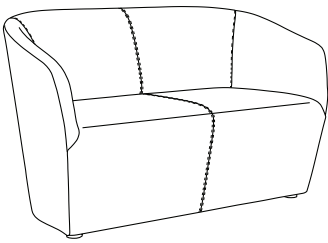
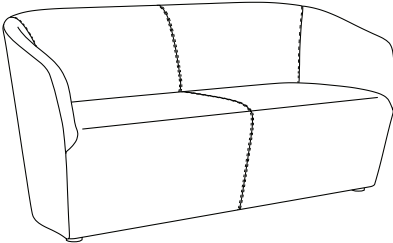
NOTE: Trinity Must Approve Fabric Selection Before Ordering.

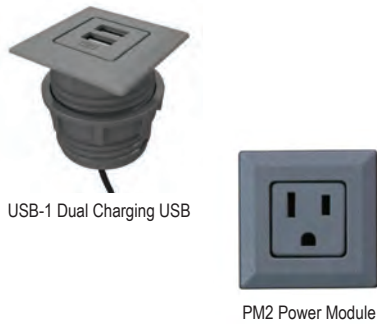
| LOUNGE | | ITEM #: | SPECIFICATIONS GRADES LIST PRICES: | | | | | | | | | | | | | | | |
|---|--|--------------|---|------------|----------|-------------------------|----------|----------|------------------------|----------|----------|----------|----------|-----------|-----------|-----------|--|--|
| TWO PLACE SOFA / FULLY UPHOLSTERED | | | Overall: 53"w 24.5"d 31.5"h | | | Arm: 25.5"h | | | COM: 6 yds. | | | | | | | | | |
| | | | Seat: 47"w 19"d 18.5"h | | | Weight: 110 lbs. | | | COL: 108 sq.ft. | | | | | | | | | |
|  | | 342-A | COM | COL | 1 | 2 | 3 | 4 | 5 | 6 | 7 | 8 | 9 | 10 | L1 | L2 | | |
| | | | 2204 | 2424 | 2376 | 2526 | 2675 | 2825 | 2974 | 3124 | 3273 | 3423 | 3572 | 3722 | 3942 | 4481 | | |
| | | | <i>Tight Seat & Back / Round Black Plastic Legs / 500 lb. Weight Capacity</i> | | | | | | | | | | | | | | | |
| THREE PLACE SOFA / FULLY UPHOLSTERED | | | Overall: 67"w 24.5"d 31.5"h | | | Arm: 25.5"h | | | COM: 7 yds. | | | | | | | | | |
| | | | Seat: 61"w 19"d 18.5"h | | | Weight: 165 lbs. | | | COL: 126 sq.ft. | | | | | | | | | |
|  | | 343-A | COM | COL | 1 | 2 | 3 | 4 | 5 | 6 | 7 | 8 | 9 | 10 | L1 | L2 | | |
| | | | 2738 | 3012 | 2941 | 3126 | 3311 | 3497 | 3682 | 3867 | 4052 | 4237 | 4422 | 4608 | 4897 | 5564 | | |
| | | | <i>Tight Seat & Back / Round Black Plastic Legs / 750 lb. Weight Capacity</i> | | | | | | | | | | | | | | | |

| STORAGE / POWER / COVERS | OPTION #: | SPECIFICATIONS LIST PRICES AVAILABILITY: |
|---|--|--|
| <p>STORAGE CUBBY</p>  | <p>Overall: n/a</p> <hr/> <p>ST1 \$226 <i>Molded plastic bottom shelf for storage. (Available In Black or Gray)</i></p> <p>Available: Swerve Collection (341 Chairs Only)</p> | |
| <p>DUAL CHARGING USB / POWER</p>  <p>USB-1 Dual Charging USB</p> <p>PM2 Power Module</p> | <p>USB-1 Overall: 2"w 2"d .1875"h PM2 Overall: 2"w 2"d .125"h</p> <hr/> <p>USB-1 \$238 <i>Spill-Proof Technology / 2 Amps Per Port / Multiple Finish Options / Storm Color Standard (Specify Left or Right Facing)</i></p> <p>PM2 \$238 Power Module (1-Power) <i>Spill-Proof Technology / Multiple Finish Options / Storm Color Standard (Specify Left or Right Facing)</i></p> <p>Available: Swerve Collection (Non-Swivel Units Only)</p> | |
| <p>CONTRASTING COVERS</p>  | <p>Overall: n/a</p> <hr/> <p>CC \$129 <i>NOTE: If Two Or More Upholsteries Or Leathers Are Used On Any Piece Of Furniture, Then A Contrast Charge Will Apply Per Order. When Using Trinity Upholstery, The Higher Priced Upholstery Grade Will Be Used In Pricing, Unless It's Trinity Leather With Fabric Contrast Welt, Or COM With Trinity Contrast Welt, Then Contact Customer Service For Pricing.</i></p> <p>Available: Swerve Collection</p> | |

Wingding

PRIVACY LOUNGE SEATING

Effective: March 1, 2025

T R I N I T Y

Date:

Page:

Modification:

Description:

DESCRIPTION:

- Upholstery Frames: Hardwood & Plywood
- Seat: High Density Foam Over Sheet Webbing
- Back: High Density Foam Over Plywood Frame
- Fixed Pillow Headrest
- 10 Year Warranty

OPTIONS:

- ST2 Storage Cubby (345-C / 345-D Models)\$270
 - USB-1 Dual Charging USB (2 Ports Available) (346 Chairs Only)\$185
 - CC Contrasting Covers\$129
- Note: Pillow Can Be A Contrasting Color From Privacy Chair*

Feather Down & Polyester Pillows Available (See Page 5)

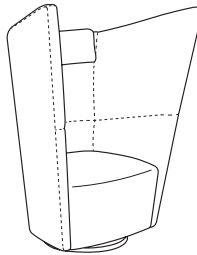
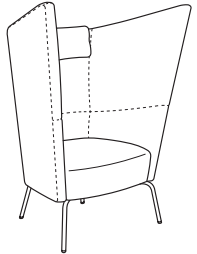
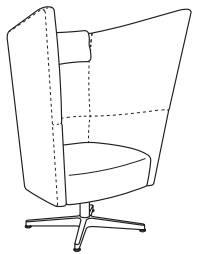
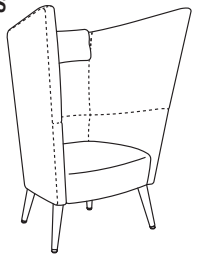
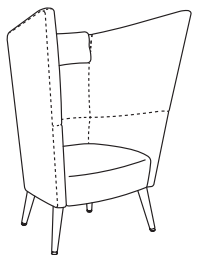



| PRIVACY LOUNGE | | ITEM #: | SPECIFICATIONS GRADES LIST PRICES: | | | | | | | | | | | | | |
|---|--|---|---|------------|--|----------|---|----------|----------|----------|----------|----------|----------|-----------|-----------|-----------|
|  <p>*NOTE* Optional Storage Cubby Available</p> | PRIVACY CHAIR W/ SWIVEL BASE | | Overall: 38.5"w 31"d 51.5"h Seat: 24.5"w 20"d 18.5"h | | Arm: n/a Weight: 100 lbs. | | COM: 6.25 yds. COL: 112.5 sq.ft. | | | | | | | | | |
| | | | COM | COL | 1 | 2 | 3 | 4 | 5 | 6 | 7 | 8 | 9 | 10 | L1 | L2 |
| | 345-C | | 1795 | 1975 | 2058 | 2239 | 2419 | 2599 | 2780 | 2960 | 3141 | 3321 | 3501 | 3682 | 3913 | 4562 |
| | | <i>Tight Seat & Back / 360° Swivel Base / 350 lb. Weight Capacity</i> | | | | | | | | | | | | | | |
| | | 345-D | 1808 | 1988 | 2070 | 2250 | 2431 | 2611 | 2791 | 2972 | 3152 | 3333 | 3513 | 3693 | 3924 | 4574 |
| | | <i>Tight Seat & Back / Self-Return 180° Swivel Base / 350 lb. Weight Capacity</i> | | | | | | | | | | | | | | |
|  | PRIVACY LOUNGE CHAIR W/ BLACK STEEL BASE | | Overall: 38.5"w 31"d 51.5"h Seat: 24.5"w 20"d 18.5"h | | Arm: n/a Weight: 85 lbs. | | COM: 5.25 yds. COL: 94.5 sq.ft. | | | | | | | | | |
| | | | COM | COL | 1 | 2 | 3 | 4 | 5 | 6 | 7 | 8 | 9 | 10 | L1 | L2 |
| | 346-A | | 1931 | 2124 | 2128 | 2280 | 2431 | 2583 | 2734 | 2886 | 3037 | 3189 | 3341 | 3492 | 3693 | 4239 |
| | | <i>Tight Seat & Back / 4 Leg - Black Steel Base / 350 lb. Weight Capacity</i> | | | | | | | | | | | | | | |
|  | PRIVACY LOUNGE CHAIR W/ FLAT POLISHED ALUMINUM BASE | | Overall: 38.5"w 31"d 51.5"h Seat: 24.5"w 20"d 18.5"h | | Arm: n/a Weight: 85 lbs. | | COM: 5.25 yds. COL: 94.5 sq.ft. | | | | | | | | | |
| | | | COM | COL | 1 | 2 | 3 | 4 | 5 | 6 | 7 | 8 | 9 | 10 | L1 | L2 |
| | 346-B | | 1808 | 1989 | 2013 | 2164 | 2316 | 2467 | 2619 | 2770 | 2922 | 3074 | 3225 | 3377 | 3578 | 4123 |
| | | <i>Tight Seat & Back / 4 Leg - Flat Polished Base / 360° Swivel Only - No Height Adjustment / 350 lb. Weight Capacity</i> | | | | | | | | | | | | | | |
|  | PRIVACY LOUNGE CHAIR W/ TAPERED BRUSHED ALUMINUM METAL LEGS | | Overall: 25.25"w 21.75"d 15"h Seat: n/a | | Arm: n/a Weight: 85 lbs. | | COM: 1.50 yds. COL: 27 sq.ft. | | | | | | | | | |
| | | | COM | COL | 1 | 2 | 3 | 4 | 5 | 6 | 7 | 8 | 9 | 10 | L1 | L2 |
| | 346-C | | 2095 | 2305 | 2231 | 2357 | 2483 | 2609 | 2735 | 2861 | 2987 | 3113 | 3239 | 3365 | 3532 | 3986 |
| | | <i>Tight Seat & Back / 4 Leg - Tapered Brushed Aluminum Metal Legs / 350 lb. Weight Capacity</i> | | | | | | | | | | | | | | |
|  | PRIVACY LOUNGE CHAIR W/ TAPERED WOODEN LEGS | | Overall: 25.25"w 21.75"d 15"h Seat: n/a | | Arm: n/a Weight: 85 lbs. | | COM: 1.50 yds. COL: 27 sq.ft. | | | | | | | | | |
| | | | COM | COL | 1 | 2 | 3 | 4 | 5 | 6 | 7 | 8 | 9 | 10 | L1 | L2 |
| | 346-D | | 1629 | 1792 | 1794 | 1922 | 2050 | 2179 | 2307 | 2436 | 2564 | 2692 | 2821 | 2949 | 3120 | 3582 |
| | | <i>Tight Seat & Back / 4 Leg - Tapered Wooden Legs / 350 lb. Weight Capacity</i> | | | | | | | | | | | | | | |

DESCRIPTION:

- Upholstery Frames: Hardwood & Plywood
- Seat: High Density Foam Over Sheet Webbing
- Back: High Density Foam Over Plywood Frame
- Fixed Pillow Headrest
- 10 Year Warranty

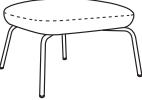
OPTIONS:

CC Contrasting Covers.....\$129

| OTTOMANS | | ITEM #: | SPECIFICATIONS GRADES LIST PRICES: | | | | | | | | | | | | | |
|---|-------|--|---|--|-----|------|------|------|------|------|------|------|------|------|------|----|
|  | 344-A | Overall: 25.25"w 21.75"d 15"h Seat: n/a | Arm: n/a Weight: 30 lbs. | COM: 1.50 yds. COL: 27 sq.ft. | | | | | | | | | | | L1 | L2 |
| | | COM | COL | 1 | 2 | 3 | 4 | 5 | 6 | 7 | 8 | 9 | 10 | L1 | L2 | |
| | | 546 | 601 | 587 | 623 | 658 | 693 | 729 | 764 | 799 | 835 | 870 | 905 | 944 | 1071 | |
| 4 Leg - Black Steel Base / 350 lb. Weight Capacity | | | | | | | | | | | | | | | | |
|  | 344-B | Overall: 25.25"w 21.75"d 15"h Seat: n/a | Arm: n/a Weight: 30 lbs. | COM: 1.50 yds. COL: 27 sq.ft. | | | | | | | | | | | L1 | L2 |
| | | COM | COL | 1 | 2 | 3 | 4 | 5 | 6 | 7 | 8 | 9 | 10 | L1 | L2 | |
| | | 531 | 584 | 573 | 608 | 644 | 679 | 714 | 750 | 785 | 820 | 856 | 891 | 930 | 1057 | |
| 4 Leg - Flat Polished Base / / No Swivel Or Height Adjustment / 350 lb. Weight Capacity | | | | | | | | | | | | | | | | |
|  | 344-C | Overall: 25.25"w 21.75"d 15"h Seat: n/a | Arm: n/a Weight: 30 lbs. | COM: 1.50 yds. COL: 27 sq.ft. | | | | | | | | | | | L1 | L2 |
| | | COM | COL | 1 | 2 | 3 | 4 | 5 | 6 | 7 | 8 | 9 | 10 | L1 | L2 | |
| | | 928 | 1021 | 949 | 985 | 1021 | 1057 | 1093 | 1129 | 1165 | 1201 | 1237 | 1273 | 1312 | 1441 | |
| 4 Leg - Tapered Brushed Aluminum Metal Legs / 350 lb. Weight Capacity | | | | | | | | | | | | | | | | |
|  | 344-D | Overall: 25.25"w 21.75"d 15"h Seat: n/a | Arm: n/a Weight: 30 lbs. | COM: 1.50 yds. COL: 27 sq.ft. | | | | | | | | | | | L1 | L2 |
| | | COM | COL | 1 | 2 | 3 | 4 | 5 | 6 | 7 | 8 | 9 | 10 | L1 | L2 | |
| | | 423 | 465 | 472 | 509 | 546 | 582 | 619 | 656 | 692 | 729 | 766 | 803 | 843 | 975 | |
| 4 Leg - Tapered Wooden Legs / 350 lb. Weight Capacity / 350 lb. Weight Capacity | | | | | | | | | | | | | | | | |

| POWER / STORAGE / COVERS | OPTION #: | SPECIFICATIONS LIST PRICES AVAILABILITY: |
|---|--|--|
| <p>DUAL CHARGING USB / POWER</p>  <p>USB-1 Dual Charging USB</p> <p>PM2 Power Module</p> | <p>USB-1 \$238 <i>Spill-Proof Technology / 2 Amps Per Port / Multiple Finish Options / Storm Color Standard (Specify Left or Right Facing)</i></p> <p>PM2 \$238 Power Module (1-Power) <i>Spill-Proof Technology / Multiple Finish Options / Storm Color Standard (Specify Left or Right Facing)</i></p> <p>Available: <i>Wingding Collection (346-A, 346-C, 346-D Non-Swivel Chairs Only)</i></p> | |
| <p>STORAGE CUBBY</p>  | <p>Overall: 22"w x 17.5"d x 11.5"h</p> <p>ST2 \$270 <i>Molded plastic bottom shelf for storage. (Available In Black or Gray)</i></p> <p>Available: <i>Wingding Collection (345-C / 345-D Chairs Only)</i></p> | |
| <p>CONTRASTING COVERS</p>  | <p>Overall: n/a</p> <p>CC \$129 <i>NOTE: If Two Or More Upholsteries Or Leathers Are Used On Any Piece Of Furniture, Then A Contrast Charge Will Apply Per Order. When Using Trinity Upholstery, The Higher Priced Upholstery Grade Will Be Used In Pricing, Unless It's Trinity Leather With Fabric Contrast Welt, Or COM With Trinity Contrast Welt, Then Contact Customer Service For Pricing.</i></p> <p><i>*Pillow Can Be A Contrasting Color From Privacy Chair</i></p> <p>Available: <i>Wingding Collection</i></p> | |

Crest

PRIVACY LOUNGE & OTTOMANS

Effective: March 1, 2025

T R I N I T Y

Date:

Page:

Modification:

Description:

DESCRIPTION:

- Upholstery Frames: Hardwood & Plywood
- Seat: High Density Foam Over Sheet Webbing
- Back: High Density Foam Over Plywood Frame
- Fixed Pillow Headrest
- 10 Year Warranty

OPTIONS:

- USB-1 Dual Charging USB (2 Ports Available) (347 Chairs Only)\$238
- CC Contrasting Covers\$129
- Note: Pillow Can Be A Contrasting Color From Privacy Chair*

Feather Down & Polyester Pillows Available (See Page 5)

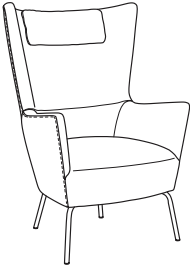
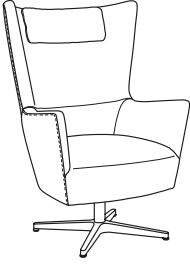
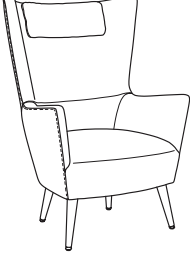
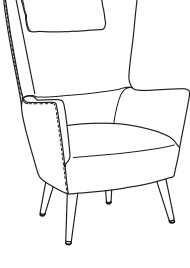



| PRIVACY LOUNGE | ITEM #: | SPECIFICATIONS GRADES LIST PRICES: | | | | | | | | | | | | | |
|---|---------|--|------------|------------------------|----------|-----------------------|----------|----------|----------|----------|----------|----------|-----------|-----------|-----------|
| PRIVACY LOUNGE CHAIR WITH BLACK STEEL BASE  | 347-A | Overall: 31.5"w 31"d 45.5"h | | Arm: 26.75"h | | COM: 4.5 yds. | | | | | | | | | |
| | | Seat: 24.5"w 20"d 18.5"h | | Weight: 75 lbs. | | COL: 81 sq.ft. | | | | | | | | | |
| | | COM | COL | 1 | 2 | 3 | 4 | 5 | 6 | 7 | 8 | 9 | 10 | L1 | L2 |
| | | 1661 | 1827 | 1781 | 1887 | 1993 | 2099 | 2205 | 2311 | 2417 | 2524 | 2630 | 2736 | 3003 | 3400 |
| <i>Tight Seat & Back / 4 Leg - Black Steel Base / 350 lb. Weight Capacity</i> | | | | | | | | | | | | | | | |
| PRIVACY LOUNGE CHAIR WITH FLAT POLISHED ALUMINUM BASE  | 347-B | Overall: 31.5"w 31"d 45.5"h | | Arm: 26.75"h | | COM: 4.5 yds. | | | | | | | | | |
| | | Seat: 24.5"w 20"d 18.5"h | | Weight: 75 lbs. | | COL: 81 sq.ft. | | | | | | | | | |
| | | COM | COL | 1 | 2 | 3 | 4 | 5 | 6 | 7 | 8 | 9 | 10 | L1 | L2 |
| | | 1698 | 1868 | 1816 | 1922 | 2028 | 2134 | 2240 | 2346 | 2452 | 2558 | 2665 | 2771 | 3040 | 3436 |
| <i>Tight Seat & Back / 4 Leg - Flat Polished Base / 360° Swivel Only - No Height Adjustment / 350 lb. Weight Capacity</i> | | | | | | | | | | | | | | | |
| PRIVACY LOUNGE CHAIR WITH TAPERED BRUSHED ALUMINUM METAL LEGS  | 347-C | Overall: 31.5"w 31"d 45.5"h | | Arm: 26.75"h | | COM: 4.5 yds. | | | | | | | | | |
| | | Seat: 24.5"w 20"d 18.5"h | | Weight: 75 lbs. | | COL: 81 sq.ft. | | | | | | | | | |
| | | COM | COL | 1 | 2 | 3 | 4 | 5 | 6 | 7 | 8 | 9 | 10 | L1 | L2 |
| | | 2126 | 2339 | 2220 | 2326 | 2432 | 2538 | 2645 | 2751 | 2857 | 2963 | 3069 | 3175 | 3332 | 3714 |
| <i>Tight Seat & Back / 4 Leg - Tapered Brushed Aluminum Metal Legs / 350 lb. Weight Capacity</i> | | | | | | | | | | | | | | | |
| PRIVACY LOUNGE CHAIR WITH TAPERED WOODEN LEGS  | 347-D | Overall: 31.5"w 31"d 45.5"h | | Arm: 26.75"h | | COM: 4.5 yds. | | | | | | | | | |
| | | Seat: 24.5"w 20"d 18.5"h | | Weight: 75 lbs. | | COL: 81 sq.ft. | | | | | | | | | |
| | | COM | COL | 1 | 2 | 3 | 4 | 5 | 6 | 7 | 8 | 9 | 10 | L1 | L2 |
| | | 1591 | 1750 | 1720 | 1830 | 1940 | 2050 | 2160 | 2271 | 2381 | 2491 | 2601 | 2711 | 2984 | 3396 |
| <i>Tight Seat & Back / 4 Leg - Tapered Wooden Legs / 350 lb. Weight Capacity</i> | | | | | | | | | | | | | | | |



DESCRIPTION:

- Upholstery Frames: Hardwood & Plywood
- Seat: High Density Foam Over Sheet Webbing
- 10 Year Warranty

OPTIONS:

CC Contrasting Covers.....\$129
 Feather Down & Polyester Pillows Available (See Page 5)

| OTTOMANS | | ITEM #: | SPECIFICATIONS GRADES LIST PRICES: | | | | | | | | | | | | |
|---|-------|--|---|--|-----|------|------|------|------|------|------|------|------|------|------|
|  | 344-A | Overall: 25.25"w 21.75"d 15"h Seat: n/a | Arm: n/a Weight: 30 lbs. | COM: 1.50 yds. COL: 27 sq.ft. | | | | | | | | | | | |
| | | COM | COL | 1 | 2 | 3 | 4 | 5 | 6 | 7 | 8 | 9 | 10 | L1 | L2 |
| | | 546 | 601 | 587 | 623 | 658 | 693 | 729 | 764 | 799 | 835 | 870 | 905 | 944 | 1071 |
| 4 Leg - Black Steel Base / 350 lb. Weight Capacity | | | | | | | | | | | | | | | |
|  | 344-B | Overall: 25.25"w 21.75"d 15"h Seat: n/a | Arm: n/a Weight: 30 lbs. | COM: 1.50 yds. COL: 27 sq.ft. | | | | | | | | | | | |
| | | COM | COL | 1 | 2 | 3 | 4 | 5 | 6 | 7 | 8 | 9 | 10 | L1 | L2 |
| | | 531 | 584 | 573 | 608 | 644 | 679 | 714 | 750 | 785 | 820 | 856 | 891 | 930 | 1057 |
| 4 Leg - Flat Polished Base / No Swivel Or Height Adjustment / 350 lb. Weight Capacity | | | | | | | | | | | | | | | |
|  | 344-C | Overall: 25.25"w 21.75"d 15"h Seat: n/a | Arm: n/a Weight: 30 lbs. | COM: 1.50 yds. COL: 27 sq.ft. | | | | | | | | | | | |
| | | COM | COL | 1 | 2 | 3 | 4 | 5 | 6 | 7 | 8 | 9 | 10 | L1 | L2 |
| | | 928 | 1021 | 949 | 985 | 1021 | 1057 | 1093 | 1129 | 1165 | 1201 | 1237 | 1273 | 1312 | 1441 |
| 4 Leg - Tapered Brushed Aluminum Metal Legs / 350 lb. Weight Capacity | | | | | | | | | | | | | | | |
|  | 344-D | Overall: 25.25"w 21.75"d 15"h Seat: n/a | Arm: n/a Weight: 30 lbs. | COM: 1.50 yds. COL: 27 sq.ft. | | | | | | | | | | | |
| | | COM | COL | 1 | 2 | 3 | 4 | 5 | 6 | 7 | 8 | 9 | 10 | L1 | L2 |
| | | 423 | 465 | 472 | 509 | 546 | 582 | 619 | 656 | 692 | 729 | 766 | 803 | 843 | 975 |
| 4 Leg - Tapered Wooden Legs / 350 lb. Weight Capacity | | | | | | | | | | | | | | | |

| POWER / CONTRASTING COVERS | OPTION #: | SPECIFICATIONS LIST PRICES AVAILABILITY: |
|--|---------------------------------------|---|
| <p>DUAL CHARGING USB / POWER</p>  <p>USB-1 Dual Charging USB</p>  <p>PM2 Power Module</p> | <p>USB-1</p> <p>PM2</p> | <p>USB-1 Overall: 2"w 2"d .1875"h PM2 Overall: 2"w 2"d .125"h</p> <hr/> <p>\$238 <i>Spill-Proof Technology / 2 Amps Per Port / Multiple Finish Options / Storm Color Standard (Specify Left or Right Facing)</i></p> <p>\$238 Power Module (1-Power) <i>Spill-Proof Technology / Multiple Finish Options / Storm Color Standard (Specify Left or Right Facing)</i></p> <p>Available: Crest Collection (347-A, 347-C, 347-D Non-Swivel Chairs Only)</p> |
| <p>CONTRASTING COVERS</p>  | <p>CC</p> | <p>Overall: n/a</p> <hr/> <p>\$129 <i>NOTE: If Two Or More Upholsteries Or Leathers Are Used On Any Piece Of Furniture, Then A Contrast Charge Will Apply Per Order. When Using Trinity Upholstery, The Higher Priced Upholstery Grade Will Be Used In Pricing, Unless It's Trinity Leather With Fabric Contrast Welt, Or COM With Trinity Contrast Welt, Then Contact Customer Service For Pricing.</i></p> <p><i>*Pillow Can Be A Contrasting Color From Privacy Chair</i></p> <p>Available: Crest Collection</p> |

Steel

GUEST SEATING

Effective: March 1, 2025

T R I N I T Y

Date:

Page:

Modification:



Description:

DESCRIPTION:

- Seat: High Density Polyurethane Foam Over Strap Webbing
- Back: High Density Polyurethane Foam Over Hardwood Frame
- Wallsaver Legs
- Brushed Stainless Steel Frame
- Top Stitching Standard
- 10 Year Warranty

OPTIONS:

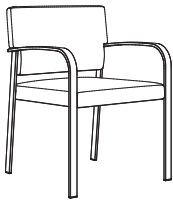
- SPAC-1 Polyester Arm Caps For Rounded Arm Units \$172 Pair
- Upholstered Arm Panels Available (See Next Page)
- Removable Velcro Seat Covers Over Antimicrobial Moisture Barrier:
 - 350-R (Item #: 350/352/360/362) \$123 List
 - 351-R (Item #: 351/353/361/363) \$128 List
 - 355-R (Item #: 355/365) \$133 List
- Contact Factory For Additional Powder Coat Frame Colors (Minimum Quantity 5)

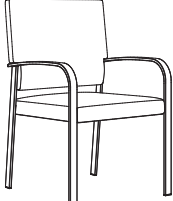
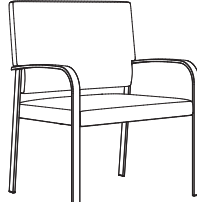
| GUEST | ITEM #: | SPECIFICATIONS GRADES LIST PRICES: | | | | | | | | | | | | | |
|--|---------|--|------------|------------------------|----------|-----------------------|----------|----------|----------|----------|----------|----------|-----------|-----------|-----------|
| SIDE CHAIR / ROUNDED ARM  | 350-B | Overall: 24"w 24"d 33"h | | Arm: 26"h | | COM: 1.5 yds. | | | | | | | | | |
| | | Seat: 21"w 19"d 19"h | | Weight: 27 lbs. | | COL: 27 sq.ft. | | | | | | | | | |
| | | COM | COL | 1 | 2 | 3 | 4 | 5 | 6 | 7 | 8 | 9 | 10 | L1 | L2 |
| | | 1438 | 1582 | 1441 | 1481 | 1522 | 1562 | 1603 | 1643 | 1684 | 1724 | 1765 | 1805 | 1873 | 2019 |
| <i>Brushed Stainless Steel Frame / Tight Seat & Back / 350 lb. Weight Capacity</i> | | | | | | | | | | | | | | | |
| BARIATRIC SIDE CHAIR / ROUNDED ARM  | 351-B | Overall: 30"w 24"d 33"h | | Arm: 26"h | | COM: 2 yds. | | | | | | | | | |
| | | Seat: 27"w 19"d 19"h | | Weight: 37 lbs. | | COL: 36 sq.ft. | | | | | | | | | |
| | | COM | COL | 1 | 2 | 3 | 4 | 5 | 6 | 7 | 8 | 9 | 10 | L1 | L2 |
| | | 1642 | 1806 | 1647 | 1694 | 1741 | 1789 | 1836 | 1883 | 1930 | 1977 | 2025 | 2072 | 2155 | 2325 |
| <i>Brushed Stainless Steel Frame / Tight Seat & Back / 500 lbs. Weight Rating / 500 lb. Weight Capacity</i> | | | | | | | | | | | | | | | |
| HIGH BACK SIDE CHAIR / ROUNDED ARM  | 352-B | Overall: 24"w 24"d 38"h | | Arm: 26"h | | COM: 1.75 yds. | | | | | | | | | |
| | | Seat: 21"w 19"d 19"h | | Weight: 32 lbs. | | COL: 32 sq.ft. | | | | | | | | | |
| | | COM | COL | 1 | 2 | 3 | 4 | 5 | 6 | 7 | 8 | 9 | 10 | L1 | L2 |
| | | 1507 | 1658 | 1506 | 1546 | 1587 | 1627 | 1668 | 1708 | 1749 | 1789 | 1830 | 1870 | 1939 | 2085 |
| <i>Brushed Stainless Steel Frame / Tight Seat & Back / 350 lb. Weight Capacity</i> | | | | | | | | | | | | | | | |
| HIGH BACK BARIATRIC SIDE CHAIR / ROUNDED ARM  | 353-B | Overall: 30"w 24"d 38"h | | Arm: 26"h | | COM: 2 yds. | | | | | | | | | |
| | | Seat: 21"w 19"d 19"h | | Weight: 42 lbs. | | COL: 36 sq.ft. | | | | | | | | | |
| | | COM | COL | 1 | 2 | 3 | 4 | 5 | 6 | 7 | 8 | 9 | 10 | L1 | L2 |
| | | 1668 | 1835 | 1671 | 1718 | 1766 | 1813 | 1860 | 1907 | 1955 | 2002 | 2049 | 2096 | 2180 | 2350 |
| <i>Brushed Stainless Steel Frame / Tight Seat & Back / 500 lbs. Weight Rating / 500 lb. Weight Capacity</i> | | | | | | | | | | | | | | | |

DESCRIPTION:

- Seat: High Density Polyurethane Foam Over Strap Webbing
- Back: High Density Polyurethane Foam Over Hardwood Frame
- Wallsaver Legs
- Brushed Stainless Steel Frame
- Top Stitching Standard
- 10 Year Warranty

OPTIONS:

- SPAC-1 Polyester Arm Caps For Rounded Arm Units \$172 Pair
- Upholstered Arm Panels Available (See Next Page)
- Removable Velcro Seat Covers Over Antimicrobial Moisture Barrier:
 - 350-R (Item #: 350/352/360/362) \$123 List
 - 351-R (Item #: 351/353/361/363) \$128 List
 - 355-R (Item #: 355/365) \$133 List
- Contact Factory For Additional Powder Coat Frame Colors (Minimum Quantity 5)

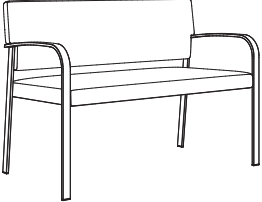
| GUEST | ITEM #: | SPECIFICATIONS GRADES LIST PRICES: | | | | | | | | | | | | | |
|--|--------------|--|------------|----------|------------------------|----------|----------|-----------------------|----------|----------|----------|----------|-----------|-----------|-----------|
| TWO PLACE SOFA / ROUNDED ARM  | 355-B | <i>Overall: 46.5"w 24"d 33"h</i> | | | <i>Arm: 26"h</i> | | | <i>COM: 3.25 yds.</i> | | | | | | | |
| | | <i>Seat: 21"/42"w 19"d 19"h</i> | | | <i>Weight: 45 lbs.</i> | | | <i>COL: 59 sq.ft.</i> | | | | | | | |
| | | COM | COL | 1 | 2 | 3 | 4 | 5 | 6 | 7 | 8 | 9 | 10 | L1 | L2 |
| | | 2114 | 2325 | 2160 | 2241 | 2322 | 2403 | 2484 | 2565 | 2646 | 2727 | 2808 | 2889 | 3019 | 3310 |
| <i>Brushed Stainless Steel Frame / Tight Seat & Back / 500 lb. Weight Capacity</i> | | | | | | | | | | | | | | | |

FINISH



Brushed
Stainless

DESCRIPTION:

- Seat: High Density Polyurethane Foam Over Strap Webbing
- Back: High Density Polyurethane Foam Over Hardwood Frame
- Wallsaver Legs
- Powder Coated Steel Frame (Luster Grey Standard)
- Brushed Stainless Steel Frame
- Top Stitching Standard
- 10 Year Warranty

OPTIONS:

- SPAC-2 Polyester Arm Caps For 90° Square Arm Units \$254 Pair
- WCA White Solid Surface Arm Caps (360-365 Chairs Only) \$250 Pair
- SGS Soft Ganging Straps \$34 Per Seat
- Upholstered Arm Panels Available (Call For Pricing)
- Removable Velcro Seat Covers Over Antimicrobial Moisture Barrier:
 - 350-R (Item #: 350/352/360/362) \$123 List
 - 351-R (Item #: 351/353/361/363) \$128 List
 - 355-R (Item #: 355/365) \$133 List
- Contact Factory For Additional Powder Coat Frame Colors (Minimum Quantity 5)

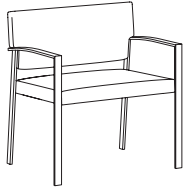
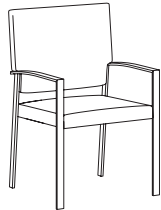
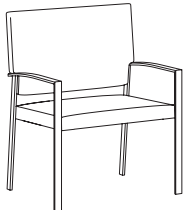
| GUEST | ITEM #: | SPECIFICATIONS GRADES LIST PRICES: | | | | | | | | | | | | | |
|---|---------------|---|------------------------|-----------------------|----------|----------|----------|----------|----------|----------|----------|----------|-----------|-----------|-----------|
|  | | Overall: 24"w 24"d 33"h | Arm: 26"h | COM: 1.5 yds. | | | | | | | | | | | |
| | | Seat: 21"w 19"d 19"h | Weight: 27 lbs. | COL: 27 sq.ft. | | | | | | | | | | | |
| | | COM | COL | 1 | 2 | 3 | 4 | 5 | 6 | 7 | 8 | 9 | 10 | L1 | L2 |
| | 360-PC | 1199 | 1319 | 1214 | 1255 | 1295 | 1336 | 1376 | 1417 | 1457 | 1498 | 1538 | 1578 | 1553 | 1691 |
| | | <i>Powder Coated Steel Frame / Tight Seat & Back / 350 lb. Weight Capacity</i> | | | | | | | | | | | | | |
| | 360-B | 1433 | 1576 | 1435 | 1476 | 1516 | 1557 | 1597 | 1638 | 1678 | 1719 | 1759 | 1800 | 1762 | 1899 |
| | | <i>Brushed Stainless Steel Frame / Tight Seat & Back / 350 lb. Weight Capacity</i> | | | | | | | | | | | | | |
|  | | Overall: 30"w 24"d 33"h | Arm: 26"h | COM: 2 yds. | | | | | | | | | | | |
| | | Seat: 27"w 19"d 19"h | Weight: 37 lbs. | COL: 36 sq.ft. | | | | | | | | | | | |
| | | COM | COL | 1 | 2 | 3 | 4 | 5 | 6 | 7 | 8 | 9 | 10 | L1 | L2 |
| | 361-PC | 1408 | 1549 | 1426 | 1473 | 1520 | 1567 | 1615 | 1662 | 1709 | 1756 | 1803 | 1851 | 1824 | 1985 |
| | | <i>Powder Coated Steel Frame / Tight Seat & Back / 500 lbs. Weight Capacity</i> | | | | | | | | | | | | | |
| | 361-B | 1636 | 1800 | 1641 | 1689 | 1736 | 1783 | 1830 | 1878 | 1925 | 1972 | 2019 | 2066 | 2028 | 2188 |
| | | <i>Brushed Stainless Steel Frame / Tight Seat & Back / 500 lbs. Weight Capacity</i> | | | | | | | | | | | | | |
|  | | Overall: 24"w 24"d 38"h | Arm: 26"h | COM: 1.75 yds. | | | | | | | | | | | |
| | | Seat: 21"w 19"d 19"h | Weight: 32 lbs. | COL: 32 sq.ft. | | | | | | | | | | | |
| | | COM | COL | 1 | 2 | 3 | 4 | 5 | 6 | 7 | 8 | 9 | 10 | L1 | L2 |
| | 362-PC | 1279 | 1407 | 1290 | 1331 | 1371 | 1411 | 1452 | 1492 | 1533 | 1573 | 1614 | 1654 | 1626 | 1763 |
| | | <i>Powder Coated Steel Frame / Tight Seat & Back / 350 lb. Weight Capacity</i> | | | | | | | | | | | | | |
| | 362-B | 1507 | 1658 | 1506 | 1546 | 1587 | 1627 | 1668 | 1708 | 1749 | 1789 | 1830 | 1870 | 1830 | 1967 |
| | | <i>Brushed Stainless Steel Frame / Tight Seat & Back / 350 lb. Weight Capacity</i> | | | | | | | | | | | | | |
|  | | Overall: 30"w 24"d 38"h | Arm: 26"h | COM: 2 yds. | | | | | | | | | | | |
| | | Seat: 21"w 19"d 19"h | Weight: 42 lbs. | COL: 36 sq.ft. | | | | | | | | | | | |
| | | COM | COL | 1 | 2 | 3 | 4 | 5 | 6 | 7 | 8 | 9 | 10 | L1 | L2 |
| | 363-PC | 1440 | 1583 | 1455 | 1503 | 1550 | 1597 | 1644 | 1691 | 1739 | 1786 | 1833 | 1880 | 1853 | 2013 |
| | | <i>Powder Coated Steel Frame / Tight Seat & Back / 500 lbs. Weight Capacity</i> | | | | | | | | | | | | | |
| | 363-B | 1668 | 1835 | 1671 | 1718 | 1766 | 1813 | 1860 | 1907 | 1955 | 2002 | 2049 | 2096 | 2057 | 2217 |
| | | <i>Brushed Stainless Steel Frame / Tight Seat & Back / 500 lbs. Weight Capacity</i> | | | | | | | | | | | | | |

DESCRIPTION:

- Seat: High Density Polyurethane Foam Over Strap Webbing
- Back: High Density Polyurethane Foam Over Hardwood Frame
- Wallsaver Legs
- Powder Coated Steel Frame (Luster Grey Standard)
- Brushed Stainless Steel Frame
- Top Stitching Standard
- 10 Year Warranty

OPTIONS:

- SPAC-2 Polyester Arm Caps For 90° Square Arm Units \$254 Pair
- WCA White Solid Surface Arm Caps (360-365 Chairs Only) \$250 Pair
- SGS Soft Ganging Straps \$34 Per Seat
- Upholstered Arm Panels Available (Call For Pricing)
- Removable Velcro Seat Covers Over Antimicrobial Moisture Barrier:
 - 350-R (Item #: 350/352/360/362) \$123 List
 - 351-R (Item #: 351/353/361/363) \$128 List
 - 355-R (Item #: 355/365) \$133 List
- Contact Factory For Additional Powder Coat Frame Colors (Minimum Quantity 5)

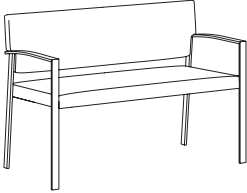
| GUEST | ITEM #: | SPECIFICATIONS GRADES LIST PRICES: | | | | | | | | | | | | | |
|--|---|--|------|------|------------------------|------|------|-----------------------|------|------|------|------|------|------|------|
|  | TWO PLACE SOFA / SQUARE ARM 365-PC 365-B | <i>Overall: 46.5"w 24"d 33"h</i> | | | <i>Arm: 26"h</i> | | | <i>COM: 3.25 yds.</i> | | | | | | | |
| | | <i>Seat: 21"/42"w 19"d 19"h</i> | | | <i>Weight: 45 lbs.</i> | | | <i>COL: 59 sq.ft.</i> | | | | | | | |
| | | COM | COL | 1 | 2 | 3 | 4 | 5 | 6 | 7 | 8 | 9 | 10 | L1 | L2 |
| | | 1885 | 2074 | 1944 | 2025 | 2106 | 2187 | 2268 | 2349 | 2430 | 2511 | 2592 | 2673 | 2644 | 2919 |
| <i>Powder Coated Steel Frame / Tight Seat & Back / 500 lb. Weight Capacity</i> | | | | | | | | | | | | | | | |
| | | 2114 | 2325 | 2160 | 2241 | 2322 | 2403 | 2484 | 2565 | 2646 | 2727 | 2808 | 2889 | 2848 | 3123 |
| <i>Brushed Stainless Steel Frame / Tight Seat & Back / 500 lb. Weight Capacity</i> | | | | | | | | | | | | | | | |

FINISHES



Brushed
Stainless

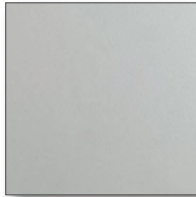

Powder Coated
Luster Grey

| ARM CAPS / STRAPS / COVERS | OPTION #: | SPECIFICATIONS LIST PRICES AVAILABILITY: |
|---|---------------|--|
| POLYESTER ARM CAPS | | |
|  | SPAC-1 | <p><i>Overall: 1.5"w 19.25"d .25"h</i></p> <hr/> <p>Polyester Arm Caps For Rounded Arm Units - \$172 (Set Of 2) <i>(Specify Finish)</i></p> <p>Available: Steel Rounded Arm Chairs: 350, 351, 352, 353, 355</p> |
| | SPAC-2 | <p>Polyester Arm Caps For 90° Square Arm Units - \$254 (Set Of 2) <i>(Specify Finish)</i></p> <p>Available: Steel 90° Square Arm Chairs: 360, 361, 362, 363, 365</p> |
| WHITE SOLID SURFACE ARM CAPS | | |
|  | WCA | <p><i>Overall: 1.375"w 14"d .4375"h</i></p> <hr/> <p>\$250 (Set Of 2) <i>(Available Only In White)</i></p> <p>Available: Steel 90° Square Arm Chairs: 360, 361, 362, 363, 365</p> |
| GANGING STRAPS | | |
|  | SGS | <p><i>Overall: 4"w 2"d</i></p> <hr/> <p>\$34 Per Seat <i>Black Velcro Soft Ganging Straps</i></p> <p>Available: Steel Chairs</p> |
| REMOVABLE COVERS | | |
|  | | <p><i>Overall: n/a</i></p> <hr/> <p>350-R \$123 (350/352/360/362 Chairs)</p> <p>351-R \$128 (351/353/361/363 Chairs)</p> <p>355-R \$133 (355/365 Chairs) <i>Removable Velcro Seat Covers Over Antimicrobial Moisture Barrier.</i></p> <p>Available: Steel Chairs</p> |

| CONTRASTING COVERS | OPTION #: | SPECIFICATIONS LIST PRICES AVAILABILITY: |
|--|---|--|
| <p data-bbox="87 178 293 205">CONTRASTING COVERS</p>  | <p data-bbox="570 178 678 205"><i>Overall: n/a</i></p> <hr/> <p data-bbox="521 268 553 296">CC</p> <p data-bbox="570 268 630 296">\$129</p> <p data-bbox="570 296 1479 369"><i>NOTE: If Two Or More Upholsteries Or Leathers Are Used On Any Piece Of Furniture, Then A Contrast Charge Will Apply Per Order. When Using Trinity Upholstery, The Higher Priced Upholstery Grade Will Be Used In Pricing, Unless It's Trinity Leather With Fabric Contrast Welt, Or COM With Trinity Contrast Welt, Then Contact Customer Service For Pricing.</i></p> <p data-bbox="570 415 756 443">Available: Steel Chairs</p> | |

Edge

LOUNGE / GUEST

Effective: March 1, 2025

T R I N I T Y

Date:

Page:

Modification:

Description:

DESCRIPTION:

- Upholstery Frames: Hardwood & Plywood
- Seat: High Density Polyurethane Foam Over Sheet Webbing
- Back: High Density Polyurethane Foam Over Hardwood Frame
- Exposed Wood Frame: Solid Maple
- Lumbar Support
- 10 Year Warranty

OPTIONS:

- Feather Down & Polyester Pillows Available (See Page 5)
- Specify Exposed Wood Finish (See Page 6)

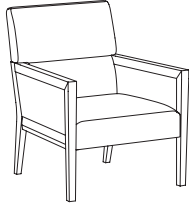
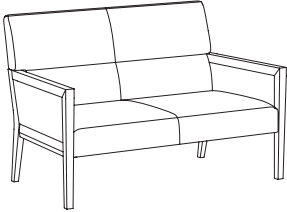
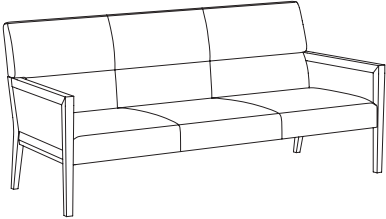
| LOUNGE | | ITEM #: | SPECIFICATIONS GRADES LIST PRICES: | | | | | | | | | | | | |
|---|-------|--|--|---|------|------|------|------|------|------|------|------|------|------|------|
|  | 371-P | Overall: 27"w 30.25"d 34.5"h Seat: 23.5"w 21"d 17.5"h | Arm: 23"h Weight: 35 lbs. | COM: 3.25 yds. COL: 59 sq.ft. | | | | | | | | | | | |
| | | COM | COL | 1 | 2 | 3 | 4 | 5 | 6 | 7 | 8 | 9 | 10 | L1 | L2 |
| | | 1485 | 1634 | 1569 | 1652 | 1734 | 1817 | 1899 | 1982 | 2064 | 2147 | 2229 | 2311 | 2433 | 2729 |
| Tight Seat & Back / 750 lb. Weight Capacity | | | | | | | | | | | | | | | |
|  | 372-P | Overall: 51"w 30.25"d 34.5"h Seat: 47.5"w 21"d 17.5"h | Arm: 23"h Weight: 65 lbs. | COM: 5.25 yds. COL: 95 sq.ft. | | | | | | | | | | | |
| | | COM | COL | 1 | 2 | 3 | 4 | 5 | 6 | 7 | 8 | 9 | 10 | L1 | L2 |
| | | 2063 | 2269 | 2225 | 2363 | 2500 | 2637 | 2775 | 2912 | 3050 | 3187 | 3325 | 3462 | 3661 | 4156 |
| Tight Seat & Back / 750 lb. Weight Capacity | | | | | | | | | | | | | | | |
|  | 373-P | Overall: 76.5"w 30.25"d 34.5"h Seat: 73"w 21"d 17.5"h | Arm: 23"h Weight: 95 lbs. | COM: 7.25 yds. COL: 131 sq.ft. | | | | | | | | | | | |
| | | COM | COL | 1 | 2 | 3 | 4 | 5 | 6 | 7 | 8 | 9 | 10 | L1 | L2 |
| | | 2565 | 2821 | 2810 | 3002 | 3195 | 3387 | 3579 | 3772 | 3964 | 4157 | 4349 | 4541 | 2676 | 2714 |
| Tight Seat & Back / 750 lb. Weight Capacity | | | | | | | | | | | | | | | |

DESCRIPTION:

- Upholstery Frames: Hardwood & Plywood
- Seat: High Density Polyurethane Foam Over Sheet Webbing
- Back: High Density Polyurethane Foam Over Hardwood Frame
- Exposed Wood Frame: Solid Maple
- Lumbar Support
- 10 Year Warranty

OPTIONS:

Feather Down & Polyester Pillows Available (See Page 5)
Specify Exposed Wood Finish (See Page 6)

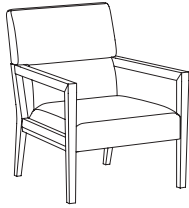
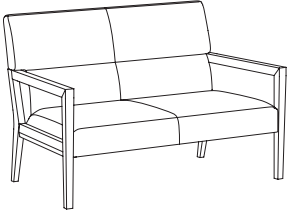
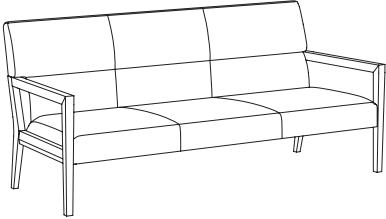
| LOUNGE | | ITEM #: | SPECIFICATIONS GRADES LIST PRICES: | | | | | | | | | | | | | |
|---|-----------------------------|---------|--|-----------------|------|-----------|-----------------|------|---------------|------|------|------|------|------|------|------|
|  | LOUNGE CHAIR / OPEN ARM | 374-P | Overall: 27"w 30.25"d 34.5"h | | | Arm: 23"h | | | COM: 2.5 yds. | | | | | | | |
| | Seat: 23.5"w 21"d 17.5"h | | | Weight: 33 lbs. | | | COL: 45 sq.ft. | | | | | | | | | |
| | COM | | COL | 1 | 2 | 3 | 4 | 5 | 6 | 7 | 8 | 9 | 10 | L1 | L2 | |
| | | | 1359 | 1495 | 1409 | 1471 | 1532 | 1594 | 1656 | 1718 | 1780 | 1842 | 1904 | 1965 | 2065 | 2287 |
| | | | <i>Tight Seat & Back / 750 lb. Weight Capacity</i> | | | | | | | | | | | | | |
|  | TWO PLACE SOFA / OPEN ARM | 375-P | Overall: 51"w 30.25"d 34.5"h | | | Arm: 23"h | | | COM: 4.5 yds. | | | | | | | |
| | Seat: 47.5"w 21"d 17.5"h | | | Weight: 63 lbs. | | | COL: 81 sq.ft. | | | | | | | | | |
| | COM | | COL | 1 | 2 | 3 | 4 | 5 | 6 | 7 | 8 | 9 | 10 | L1 | L2 | |
| | | | 1940 | 2134 | 2068 | 2185 | 2302 | 2418 | 2535 | 2652 | 2769 | 2886 | 3003 | 3119 | 3297 | 3717 |
| | | | <i>Tight Seat & Back / 750 lb. Weight Capacity</i> | | | | | | | | | | | | | |
|  | THREE PLACE SOFA / OPEN ARM | 376-P | Overall: 76.5"w 30.25"d 34.5"h | | | Arm: 23"h | | | COM: 6.5 yds. | | | | | | | |
| | Seat: 73"w 21"d 17.5"h | | | Weight: 93 lbs. | | | COL: 117 sq.ft. | | | | | | | | | |
| | COM | | COL | 1 | 2 | 3 | 4 | 5 | 6 | 7 | 8 | 9 | 10 | L1 | L2 | |
| | | | 2439 | 2682 | 2649 | 2821 | 2993 | 3165 | 3336 | 3508 | 3680 | 3852 | 4024 | 4195 | 5688 | 5860 |
| | | | <i>Tight Seat & Back / 750 lb. Weight Capacity</i> | | | | | | | | | | | | | |

DESCRIPTION:

- Upholstery Frames: Hardwood & Plywood
- Seat: High Density Polyurethane Foam Over Sheet Webbing
- Back: High Density Polyurethane Foam Over Hardwood Frame
- Exposed Wood Frame: Solid Maple
- Wallsaver Legs
- 10 Year Warranty

OPTIONS:

Specify Exposed Wood Finish (See Page 6)

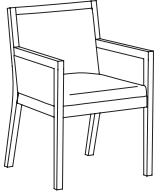
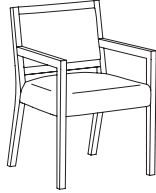
| GUEST | ITEM #: | SPECIFICATIONS GRADES LIST PRICES: | | | | | | | | | | | | | |
|---|------------|---|------------|----------|------------------------|----------|----------|---|----------|----------|----------|----------|-----------|-----------|-----------|
| SIDE CHAIR / CLOSED ARM / CLOSED BACK  | | Overall: 22"w 24"d 33"h | | | Arm: 25"h | | | COM: 2 yds. (380) / 2 yds. (381) | | | | | | | |
| | | Seat: 19.5"w 17.75"d 18.75"h | | | Weight: 26 lbs. | | | COL: 36 sq.ft. (380) / 36 sq.ft. (381) | | | | | | | |
| | | COM | COL | 1 | 2 | 3 | 4 | 5 | 6 | 7 | 8 | 9 | 10 | L1 | L2 |
| | 380 | 1022 | 1124 | 1062 | 1110 | 1159 | 1207 | 1255 | 1303 | 1351 | 1399 | 1447 | 1495 | 1550 | 1723 |
| | | <i>Upholstered Back / Tight Seat & Back / 350 lb. Weight Capacity</i> | | | | | | | | | | | | | |
| | 381 | 1058 | 1163 | 1096 | 1144 | 1192 | 1241 | 1289 | 1337 | 1385 | 1433 | 1481 | 1529 | 1582 | 1755 |
| | | <i>Wood Back / Tight Seat & Back / 350 lb. Weight Capacity</i> | | | | | | | | | | | | | |
| SIDE CHAIR / OPEN ARM / OPEN BACK  | | Overall: 22"w 24"d 33"h | | | Arm: 25"h | | | COM: 1.5 yds. (384) / 1.25 yds. (385) | | | | | | | |
| | | Seat: 19.5"w 17.75"d 18.75"h | | | Weight: 17 lbs. | | | COL: 27 sq.ft. (384) / 23 sq.ft. (385) | | | | | | | |
| | | COM | COL | 1 | 2 | 3 | 4 | 5 | 6 | 7 | 8 | 9 | 10 | L1 | L2 |
| | 384 | 939 | 1033 | 970 | 1012 | 1053 | 1094 | 1135 | 1177 | 1218 | 1259 | 1300 | 1341 | 1392 | 1541 |
| | | <i>Upholstered Back / Tight Seat & Back / 350 lb. Weight Capacity</i> | | | | | | | | | | | | | |
| | 385 | 962 | 1058 | 973 | 992 | 1019 | 1047 | 1074 | 1102 | 1129 | 1157 | 1184 | 1212 | 1249 | 1348 |
| | | <i>Wood Back / Tight Seat & Back / 350 lb. Weight Capacity</i> | | | | | | | | | | | | | |

DESCRIPTION:

- Exposed Frames: Solid Maple, Self Edge, Vertical Direction
- Veneer Top: Maple
- 10 Year Warranty

OPTIONS:

Specify Exposed Wood Finish / Laminate (See Page 6)

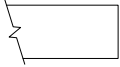

Square Edge Profile Standard

TABLES

ROUND OCCASIONAL TABLE



322D23-V

322D23-C

322D23-G

Overall: 22" Diameter 23"h
Weight: 45 lbs.

COM COL 1 2 3 4 5 6 7 8 9 10 L1 L2

1336
Veneer Face / Self Edge

1455
Solid Surface Face / Self Edge

CALL
Etched Tempered Glass / Eased Edge

SQUARE OCCASIONAL TABLE



3242423-V

3242423-C

3242423-G

Overall: 24"w 24"d 23"h
Weight: 47 lbs.

COM COL 1 2 3 4 5 6 7 8 9 10 L1 L2

1199
Veneer Face / Self Edge

1688
Solid Surface Face / Self Edge

CALL
Etched Tempered Glass / Eased Edge

ROUND COFFEE TABLE

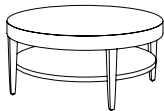

336D16-V

336D16-C

336D16-G

Overall: 36" Diameter 16"h
Weight: 65 lbs.

COM COL 1 2 3 4 5 6 7 8 9 10 L1 L2

2190
Veneer Face / Self Edge

2674
Solid Surface Face / Self Edge

CALL
Etched Tempered Glass / Eased Edge

SQUARE OCCASIONAL TABLE

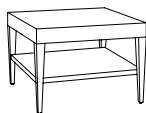

3242416-V

3242416-C

3242416-G



Overall: 24"w 24"d 16"h
Weight: 40 lbs.

COM COL 1 2 3 4 5 6 7 8 9 10 L1 L2

1158
Veneer Face / Self Edge

1659
Solid Surface Face / Self Edge

CALL
Etched Tempered Glass / Eased Edge

| COVERS | OPTION #: | SPECIFICATIONS LIST PRICES AVAILABILITY: |
|---|--|--|
| <p data-bbox="87 178 289 205">POLYESTER ARM CAPS</p>  <p data-bbox="87 480 285 508">RPAC-3 Polyester Arm Cap</p> | <p data-bbox="570 178 816 205">Overall: 3.625"w 30.25"d .5"h</p> <hr/> <p data-bbox="570 268 946 323">RPAC-3 \$173 (Set Of 2) Black Polyester Arm Cap (Additional Colors Available)</p> <p data-bbox="570 344 802 371">Available: Edge Guest Chairs</p> <hr/> <p data-bbox="570 642 678 669">Overall: n/a</p> | |
| <p data-bbox="87 642 293 669">CONTRASTING COVERS</p>  | <p data-bbox="570 730 1479 831">CC \$129 <i>NOTE: If Two Or More Upholsteries Or Leathers Are Used On Any Piece Of Furniture, Then A Contrast Charge Will Apply Per Order. When Using Trinity Upholstery, The Higher Priced Upholstery Grade Will Be Used In Pricing, Unless It's Trinity Leather With Fabric Contrast Welt, Or COM With Trinity Contrast Welt, Then Contact Customer Service For Pricing.</i></p> <p data-bbox="570 877 781 905">Available: Edge Collection</p> | |

Traditional

EXECUTIVE / GUEST / LOUNGE / TABLES

Effective: March 1, 2025

T R I N I T Y

Date:

Page:

Modification:

Description:

DESCRIPTION:

- Upholstery Frames: Hardwood & Plywood
- Seat: High Density Polyurethane Foam Over Woven Rubber Webbing
- Back: High Density Polyurethane Foam Over Sinuous Wire Springs
- Upholstered Arms: Polyurethane Foam Over Hardwood
- Exposed Arms: Solid Cherry, Lacquer Finished
- Classic Base Standard
- 10 Year Warranty

OPTIONS:

Specify Exposed Wood Finish (See Page 6)
 Base & Caster Options Available (See Traditional Options Pages)
 Brass or Pewter Nail Head Trim (See Traditional Options Pages)

Note: Trinity Must Approve Specific Fabrics / Leathers Used For Tufting.

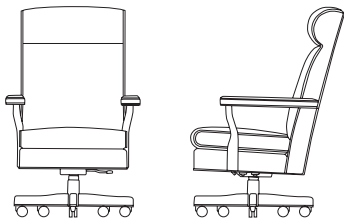
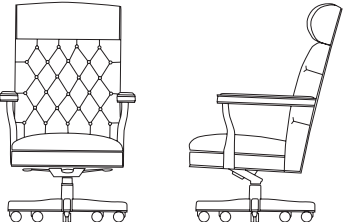
| JUDGES / CHAMBERLAIN | ITEM #: | SPECIFICATIONS GRADES LIST PRICES: | | | | | | | | | | | | | |
|--|---------|--|------------|------------------------|----------|-------------------------|----------|----------|----------|----------|----------|----------|-----------|-----------|-----------|
| <p>HIGH BACK JUDGES CHAIR / OPEN WOOD UPHOLSTERED ARM / LOOSE CUSHION</p>  | 400-3 | Overall: 28.25"w 33"d 48"-52"h | | Arm: 30"-33"h | | COM: 3.75 yds. | | | | | | | | | |
| | | Seat: 24.75"w 20"d 21"-24"h | | Weight: 85 lbs. | | COL: 67.5 sq.ft. | | | | | | | | | |
| | | COM | COL | 1 | 2 | 3 | 4 | 5 | 6 | 7 | 8 | 9 | 10 | L1 | L2 |
| | | 1886 | 2074 | 2102 | 2210 | 2319 | 2427 | 2535 | 2643 | 2752 | 2860 | 2968 | 3076 | 3246 | 3636 |
| <i>Tilt Swivel Infinite Lock / Pneumatic Seat Height Adjustment / 350 lb. Weight Capacity</i> | | | | | | | | | | | | | | | |
| <p>HIGH BACK JUDGES CHAIR / OPEN WOOD UPHOLSTERED ARM / TUFTED BACK / TIGHT CUSHION</p>  | 401-3 | Overall: 28.25"w 33"d 48"-52"h | | Arm: 30"-33"h | | COM: 3.75 yds. | | | | | | | | | |
| | | Seat: 24.75"w 20"d 21"-24"h | | Weight: 85 lbs. | | COL: 67.5 sq.ft. | | | | | | | | | |
| | | COM | COL | 1 | 2 | 3 | 4 | 5 | 6 | 7 | 8 | 9 | 10 | L1 | L2 |
| | | 2048 | 2253 | 2265 | 2373 | 2481 | 2589 | 2698 | 2806 | 2914 | 3022 | 3131 | 3239 | 3427 | 3817 |
| <i>Tilt Swivel Infinite Lock / Pneumatic Seat Height Adjustment / 350 lb. Weight Capacity</i> | | | | | | | | | | | | | | | |
| | 401-4 | 2065 | 2272 | 2282 | 2390 | 2498 | 2607 | 2715 | 2823 | 2931 | 3040 | 3148 | 3256 | 3444 | 3834 |
| <i>Knee Tilt Swivel Infinite Lock / Pneumatic Seat Height Adjustment / 350 lb. Weight Capacity</i> | | | | | | | | | | | | | | | |

DESCRIPTION:

- Upholstery Frames: Hardwood & Plywood
- Seat: High Density Polyurethane Foam Over Woven Rubber Webbing
- Back: High Density Polyurethane Foam Over Sinuous Wire Springs
- Upholstered Arms: Polyurethane Foam Over Hardwood
- Exposed Arms: Solid Cherry, Lacquer Finished
- Classic Base Standard
- 10 Year Warranty

OPTIONS:

Specify Exposed Wood Finish (See Page 6)
 Base & Caster Options Available (See Traditional Options Pages)
 Brass or Pewter Nail Head Trim (See Traditional Options Pages)

Note: Trinity Must Approve Specific Fabrics / Leathers Used For Tufting.

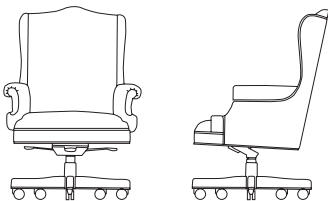
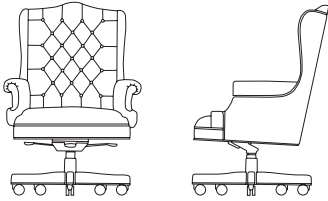
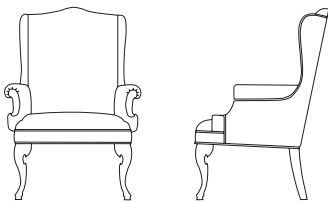
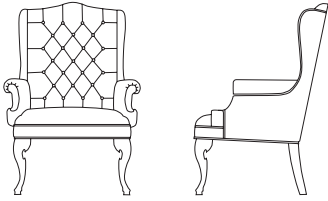
| BARRISTER | | ITEM #: | SPECIFICATIONS GRADES LIST PRICES: | | | | | | | | | | | | | |
|---|--|--------------|--|------------|----------|--|----------|----------|---|----------|----------|----------|----------|-----------|-----------|-----------|
|  | | | Overall: 31"w 32"d 44"-47"h Seat: 21"w 19.5"d 19"-22"h | | | Arm: 28"-31"h Weight: 80 lbs. | | | COM: 5 yds. COL: 90 sq.ft. | | | | | | | |
| | | | COM | COL | 1 | 2 | 3 | 4 | 5 | 6 | 7 | 8 | 9 | 10 | L1 | L2 |
| | | 410-3 | 1735 | 1909 | 2010 | 2147 | 2284 | 2421 | 2558 | 2695 | 2832 | 2969 | 3106 | 3244 | 3437 | 3931 |
| | | | <i>Tilt Swivel Infinite Lock / Pneumatic Seat Height Adjustment / 350 lb. Weight Capacity</i> | | | | | | | | | | | | | |
| | | 410-4 | 1764 | 1941 | 2038 | 2176 | 2313 | 2450 | 2587 | 2724 | 2861 | 2998 | 3135 | 3272 | 3466 | 3960 |
| | | | <i>Knee Tilt Swivel w/ Infinite Lock / Pneumatic Seat Height Adjustment / 350 lb. Weight Capacity</i> | | | | | | | | | | | | | |
|  | | | Overall: 31"w 32"d 44"-47"h Seat: 21"w 19.5"d 19"-22"h | | | Arm: 28"-31"h Weight: 80 lbs. | | | COM: 5.25 yds. COL: 94.5 sq.ft. | | | | | | | |
| | | | COM | COL | 1 | 2 | 3 | 4 | 5 | 6 | 7 | 8 | 9 | 10 | L1 | L2 |
| | | 411-3 | 2196 | 2415 | 2499 | 2650 | 2802 | 2953 | 3105 | 3256 | 3408 | 3559 | 3711 | 3863 | 4127 | 4672 |
| | | | <i>Tilt Swivel Infinite Lock / Pneumatic Seat Height Adjustment / Tight Seat & Tufted Back / 350 lb. Weight Capacity</i> | | | | | | | | | | | | | |
| | | 411-4 | 2236 | 2460 | 2539 | 2691 | 2842 | 2994 | 3145 | 3297 | 3448 | 3600 | 3751 | 3903 | 4167 | 4713 |
| | | | <i>Knee Tilt Swivel w/ Infinite Lock / Pneumatic Seat Height Adjustment / Tight Seat & Tufted Back / 350 lb. Weight Capacity</i> | | | | | | | | | | | | | |
|  | | | Overall: 31"w 32"d 44"h Seat: 21"w 19.5"d 20"h | | | Arm: 28"h Weight: 62 lbs. | | | COM: 5 yds. (415-P) / 5.25 yds. (415-T) COL: 90 sq.ft. (415-P) / 94.5 sq.ft. (415-T) | | | | | | | |
| | | | COM | COL | 1 | 2 | 3 | 4 | 5 | 6 | 7 | 8 | 9 | 10 | L1 | L2 |
| | | 415-P | 1605 | 1765 | 1879 | 2016 | 2153 | 2290 | 2427 | 2565 | 2702 | 2839 | 2976 | 3113 | 3307 | 3800 |
| | | | <i>Tight Seat & Back / 350 lb. Weight Capacity</i> | | | | | | | | | | | | | |
| | | 415-T | 1959 | 2155 | 2262 | 2414 | 2565 | 2717 | 2868 | 3020 | 3171 | 3323 | 3474 | 3626 | 3890 | 4436 |
| | | | <i>Tight Seat & Tufted Back / 350 lb. Weight Capacity</i> | | | | | | | | | | | | | |
|  | | | | | | | | | | | | | | | | |
| | | | | | | | | | | | | | | | | |

DESCRIPTION:

- Upholstery Frames: Hardwood & Plywood
- Seat: High Density Polyurethane Foam Over Woven Rubber Webbing
- Back: High Density Polyurethane Foam Over Polypropylene Webbing
- Upholstered Arms: Polyurethane Foam Over Hardwood
- Exposed Arms: Solid Cherry, Lacquer Finished
- Classic Base Standard
- 10 Year Warranty

OPTIONS:

- CCM Concentric Arm Medalion (430 Model)..... N/C
- Specify Exposed Wood Finish (See Page 6)
 Base & Caster Options Available (See Traditional Options Pages)
 Brass or Pewter Nail Head Trim (See Traditional Options Pages)

Note: Trinity Must Approve Specific Fabrics / Leathers Used For Tufting.

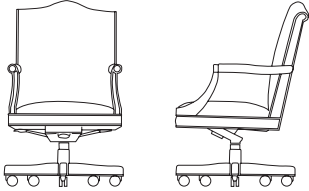
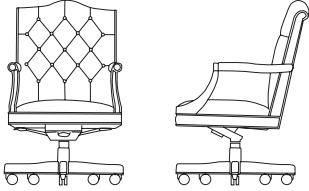
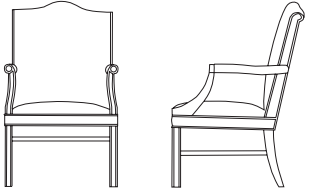
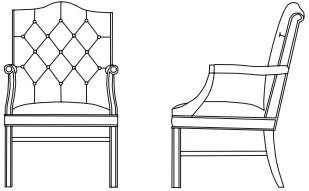
| WASHINGTON | ITEM #: | SPECIFICATIONS GRADES LIST PRICES: | | | | | | | | | | | | | | | |
|---|--------------|---|------------|----------|--|----------|----------|---|----------|----------|----------|----------|-----------|-----------|-----------|--|--|
| <p>MEDIUM BACK CHAIR / OPEN WOOD UPHOLSTERED ARM</p>  | | Overall: 24"w 29"d 40"-43"h Seat: 20"w 19"d 19"-22"h | | | Arm: 27"-30"h Weight: 60 lbs. | | | COM: 2.75 yds. COL: 49.5 sq.ft. | | | | | | | | | |
| | | COM | COL | 1 | 2 | 3 | 4 | 5 | 6 | 7 | 8 | 9 | 10 | L1 | L2 | | |
| | 430-2 | 1683 | 1851 | 1851 | 1935 | 2019 | 2103 | 2187 | 2271 | 2355 | 2440 | 2524 | 2608 | 2729 | 3032 | | |
| | | <i>Tilt Swivel w/ Lock / Pneumatic Seat Height Adjustment / 350 lb. Weight Capacity</i> | | | | | | | | | | | | | | | |
| | 430-4 | 1733 | 1906 | 1901 | 1985 | 2069 | 2154 | 2238 | 2322 | 2406 | 2490 | 2574 | 2658 | 2780 | 3082 | | |
| | | <i>Knee Tilt Swivel w/ Infinite Lock / Pneumatic Seat Height Adjustment / 350 lb. Weight Capacity</i> | | | | | | | | | | | | | | | |
| <p>MEDIUM BACK CHAIR / OPEN WOOD UPHOLSTERED ARM / TUFTED BACK</p>  | | Overall: 24"w 29"d 40"-43"h Seat: 20"w 19"d 19"-22"h | | | Arm: 27"-30"h Weight: 60 lbs. | | | COM: 3 yds. COL: 54 sq.ft. | | | | | | | | | |
| | | COM | COL | 1 | 2 | 3 | 4 | 5 | 6 | 7 | 8 | 9 | 10 | L1 | L2 | | |
| | 431-2 | 1967 | 2164 | 2122 | 2199 | 2276 | 2353 | 2430 | 2507 | 2584 | 2661 | 2738 | 2816 | 2962 | 3240 | | |
| | | <i>Tilt Swivel w/ Lock / Pneumatic Seat Height Adjustment / 350 lb. Weight Capacity</i> | | | | | | | | | | | | | | | |
| | 431-4 | 2018 | 2220 | 2172 | 2249 | 2326 | 2403 | 2480 | 2558 | 2635 | 2712 | 2789 | 2866 | 3012 | 3290 | | |
| | | <i>Knee Tilt Swivel w/ Infinite Lock / Pneumatic Seat Height Adjustment / 350 lb. Weight Capacity</i> | | | | | | | | | | | | | | | |
| <p>ARM CHAIR / EXPOSED WOOD OPEN UPHOLSTERED ARM</p>  <p>435-P</p>  <p>435-T</p> | | Overall: 24"w 29"d 40"h Seat: 20"w 19"d 19"h | | | Arm: 27"h Weight: 45 lbs. | | | COM: 2.75 yds. (435-P) / 3 yds. (435-T) COL: 49.5 sq.ft. (435-P) / 54 sq.ft. (435-T) | | | | | | | | | |
| | | COM | COL | 1 | 2 | 3 | 4 | 5 | 6 | 7 | 8 | 9 | 10 | L1 | L2 | | |
| | 435-P | 1565 | 1721 | 1733 | 1817 | 1901 | 1985 | 2069 | 2154 | 2238 | 2322 | 2406 | 2490 | 2611 | 2914 | | |
| | | <i>Tight Seat & Back / 350 lb. Weight Capacity</i> | | | | | | | | | | | | | | | |
| | 435-T | 1794 | 1973 | 1962 | 2046 | 2130 | 2214 | 2298 | 2382 | 2466 | 2551 | 2635 | 2719 | 2870 | 3173 | | |
| | | <i>Tight Seat / Tufted Back / 350 lb. Weight Capacity</i> | | | | | | | | | | | | | | | |

DESCRIPTION:

- Upholstery Frames: Hardwood & Plywood
- Seat: High Density Polyurethane Foam Over Woven Rubber Webbing
- Back: High Density Polyurethane Foam Over Polypropylene Webbing
- Upholstered Arms: Polyurethane Foam Over Hardwood
- Exposed Arms: Solid Cherry, Lacquer Finished
- Classic Base Standard (Executive Chairs)
- 10 Year Warranty

OPTIONS:

Specify Exposed Wood Finish (See Page 6)
 Base & Caster Options Available (See Traditional Options Pages)
 Brass or Pewter Nail Head Trim (See Traditional Options Pages)

Note: Trinity Must Approve Specific Fabrics / Leathers Used For Tufting.

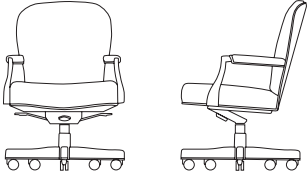
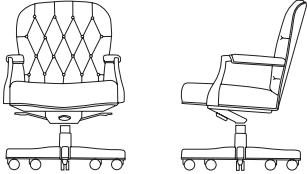
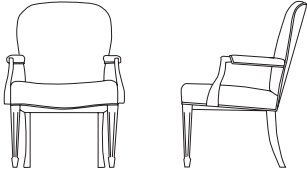
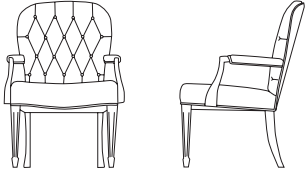
| GEORGETOWN | | ITEM #: | SPECIFICATIONS GRADES LIST PRICES: | | | | | | | | | | | | | |
|---|--|--------------|--|------------|----------|------------------------|----------|----------|---|----------|----------|----------|----------|-----------|-----------|-----------|
| LOW BACK CHAIR / OPEN WOOD UPHOLSTERED ARM / FULLY UPHOLSTERED | | | Overall: 25"w 26"d 36"-39"h | | | Arm: 25"-28"h | | | COM: 2.25 yds. | | | | | | | |
| | | | Seat: 21.5"w 18"d 18"-21"h | | | Weight: 55 lbs. | | | COL: 40.5 sq.ft. | | | | | | | |
|  | | | COM | COL | 1 | 2 | 3 | 4 | 5 | 6 | 7 | 8 | 9 | 10 | L1 | L2 |
| | | 440-2 | 1411 | 1552 | 1523 | 1579 | 1635 | 1691 | 1747 | 1803 | 1859 | 1915 | 1971 | 2027 | 2118 | 2320 |
| | | | <i>Tilt Swivel w/ Lock / Pneumatic Seat Height Adjustment / 350 lb. Weight Capacity</i> | | | | | | | | | | | | | |
| | | 440-4 | 1467 | 1613 | 1579 | 1635 | 1691 | 1747 | 1803 | 1859 | 1915 | 1971 | 2027 | 2083 | 2175 | 2376 |
| | | | <i>Knee Tilt Swivel w/ Infinite Lock / Pneumatic Seat Height Adjustment / 350 lb. Weight Capacity</i> | | | | | | | | | | | | | |
| LOW BACK CHAIR / OPEN WOOD UPHOLSTERED ARM / TIGHT SEAT & TUFTED BACK | | | Overall: 25"w 26"d 36"-39"h | | | Arm: 25"-28"h | | | COM: 2.25 yds. | | | | | | | |
| | | | Seat: 21.5"w 18"d 18"-21"h | | | Weight: 55 lbs. | | | COL: 40.5 sq.ft. | | | | | | | |
|  | | | COM | COL | 1 | 2 | 3 | 4 | 5 | 6 | 7 | 8 | 9 | 10 | L1 | L2 |
| | | 441-2 | 1619 | 1781 | 1788 | 1872 | 1956 | 2040 | 2124 | 2208 | 2292 | 2376 | 2461 | 2545 | 2690 | 2993 |
| | | | <i>Tilt Swivel w/ Lock / Pneumatic Seat Height Adjustment / Tight Seat & Tufted Back / 350 lb. Weight Capacity</i> | | | | | | | | | | | | | |
| | | 441-4 | 1670 | 1837 | 1838 | 1922 | 2006 | 2090 | 2175 | 2259 | 2343 | 2427 | 2511 | 2595 | 2741 | 3044 |
| | | | <i>Knee Tilt Swivel w/ Infinite Lock / Pneumatic Seat Height Adjustment / Tight Seat & Tufted Back / 350 lb. Weight Capacity</i> | | | | | | | | | | | | | |
| ARM CHAIR / OPEN WOOD UPHOLSTERED ARM | | | Overall: 25"w 26"d 36"h | | | Arm: 26"h | | | COM: 2.25 yds. (445-P) / 2.5 yds. (445-T) | | | | | | | |
| | | | Seat: 21.5"w 18"d 20"h | | | Weight: 45 lbs. | | | COL: 40.5 sq.ft. (445-P) / 45 sq.ft. (445-T) | | | | | | | |
|  | | | COM | COL | 1 | 2 | 3 | 4 | 5 | 6 | 7 | 8 | 9 | 10 | L1 | L2 |
| | | 445-P | 1315 | 1446 | 1469 | 1546 | 1623 | 1700 | 1777 | 1854 | 1932 | 2009 | 2086 | 2163 | 2270 | 2548 |
| | | | <i>Tight Seat & Back / 350 lb. Weight Capacity</i> | | | | | | | | | | | | | |
| | | 445-T | 1521 | 1674 | 1690 | 1774 | 1858 | 1942 | 2026 | 2110 | 2194 | 2278 | 2363 | 2447 | 2592 | 2895 |
| | | | <i>Tight Seat & Tufted Back / 350 lb. Weight Capacity</i> | | | | | | | | | | | | | |
|  | | | | | | | | | | | | | | | | |
| | | 445-P | | | | | | | | | | | | | | |
| | | 445-T | | | | | | | | | | | | | | |

DESCRIPTION:

- Upholstery Frames: Hardwood & Plywood
- Seat: High Density Polyurethane Foam Over Woven Rubber Webbing
- Back: High Density Polyurethane Foam Over Polypropylene Webbing (Item #: 448 - Strap Webbing)
- Upholstered Arms: Polyurethane Foam Over Hardwood
- Exposed Arms / Legs: Solid Maple, Lacquer Finished (#446, #447, #448)
- Classic Base Standard
- 10 Year Warranty

OPTIONS:

- Specify Exposed Wood Finish (See Page 6)
- Base & Caster Options Available (See Traditional Options Pages)
- Brass or Pewter Nail Head Trim (See Traditional Options Pages)

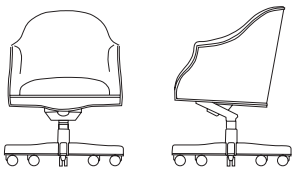
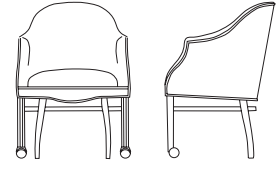
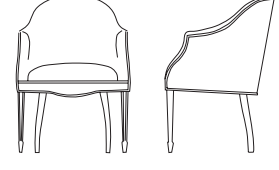
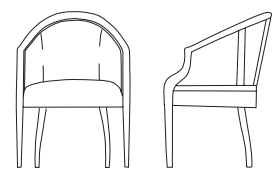
| FAIRFORD / BARREL CHAIR | | ITEM #: | SPECIFICATIONS GRADES LIST PRICES: | | | | | | | | | | | | | |
|---|--|--------------|---|------------|----------|------------------------|----------|----------|-------------------------|----------|----------|----------|----------|-----------|-----------|-----------|
|  | | | Overall: 24.5"w 26"d 32.5"-36"h | | | Arm: 26.5"-30"h | | | COM: 3.25 yds. | | | | | | | |
| | | | Seat: 20"w 18"d 18.5"-21.5"h | | | Weight: 45 lbs. | | | COL: 58.5 sq.ft. | | | | | | | |
| | | | COM | COL | 1 | 2 | 3 | 4 | 5 | 6 | 7 | 8 | 9 | 10 | L1 | L2 |
| | | 442-2 | 1509 | 1600 | 1628 | 1715 | 1801 | 1888 | 1975 | 2061 | 2148 | 2234 | 2321 | 2407 | 2534 | 2846 |
| | | | <i>Tilt Swivel w/ Lock / Pneumatic Seat Height Adjustment / 350 lb. Weight Capacity</i> | | | | | | | | | | | | | |
| | | 442-4 | 1569 | 1664 | 1686 | 1772 | 1859 | 1946 | 2032 | 2119 | 2205 | 2292 | 2379 | 2465 | 2592 | 2903 |
| | | | <i>Knee Tilt Swivel w/ Infinite Lock / Pneumatic Seat Height Adjustment / 350 lb. Weight Capacity</i> | | | | | | | | | | | | | |
|  | | | Overall: 24.5"w 24.5"d 34"h | | | Arm: 27"h | | | COM: 3.25 yds. | | | | | | | |
| | | | Seat: 20"w 18"d 18"h | | | Weight: 45 lbs. | | | COL: 58.5 sq.ft. | | | | | | | |
| | | | COM | COL | 1 | 2 | 3 | 4 | 5 | 6 | 7 | 8 | 9 | 10 | L1 | L2 |
| | | 446 | 1245 | 1320 | 1369 | 1453 | 1537 | 1621 | 1705 | 1789 | 1873 | 1957 | 2042 | 2126 | 2249 | 2551 |
| | | | <i>Tight Seat & Back / Front Casters / 350 lb. Weight Capacity</i> | | | | | | | | | | | | | |
|  | | | Overall: 24.5"w 24.5"d 34"h | | | Arm: 27"h | | | COM: 3.25 yds. | | | | | | | |
| | | | Seat: 20"w 18"d 18"h | | | Weight: 45 lbs. | | | COL: 58.5 sq.ft. | | | | | | | |
| | | | COM | COL | 1 | 2 | 3 | 4 | 5 | 6 | 7 | 8 | 9 | 10 | L1 | L2 |
| | | 447 | 1287 | 1365 | 1409 | 1493 | 1578 | 1662 | 1746 | 1830 | 1914 | 1998 | 2082 | 2166 | 2176 | 2478 |
| | | | <i>Tight Seat & Back / 350 lb. Weight Capacity</i> | | | | | | | | | | | | | |
|  | | | Overall: 25.5"w 23"d 31"h | | | Arm: 26"h | | | COM: 2.25 yds. | | | | | | | |
| | | | Seat: 21"w 18.75"d 19"h | | | Weight: 45 lbs. | | | COL: 40.5 sq.ft. | | | | | | | |
| | | | COM | COL | 1 | 2 | 3 | 4 | 5 | 6 | 7 | 8 | 9 | 10 | L1 | L2 |
| | | 448 | 1593 | 1690 | 1652 | 1710 | 1767 | 1825 | 1883 | 1940 | 1998 | 2056 | 2114 | 2171 | 2287 | 2495 |
| | | | <i>Tight Seat & Back / 350 lb. Weight Capacity</i> | | | | | | | | | | | | | |

Standard With Brass Nail Head Trim

DESCRIPTION:

- Upholstery Frames: Hardwood & Plywood
- Seat: High Density Polyurethane Foam Over Woven Rubber Webbing
- Back: High Density Polyurethane Foam Over Polypropylene Webbing
- Upholstered Arms: Polyurethane Foam Over Hardwood
- Exposed Arms: Solid Cherry, Lacquer Finished (#450 / #455 Arms Are Solid Steam Bent Cherry)
- Classic Base Standard (450-2 & 450-4)
- 10 Year Warranty

OPTIONS:

Specify Exposed Wood Finish (See Page 6)
 Base & Caster Options Available (See Traditional Options Pages)
 Brass or Pewter Nail Head Trim (See Traditional Options Pages)

Note: Trinity Must Approve Specific Fabrics / Leathers Used For Tufting.

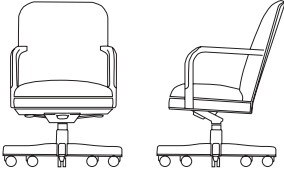
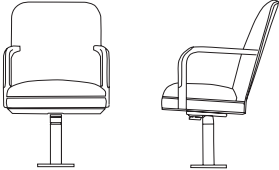
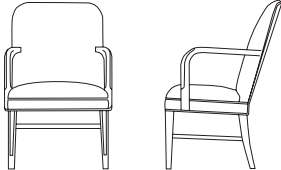
| RALEIGH | ITEM #: | SPECIFICATIONS GRADES LIST PRICES: | | | | | | | | | | | | | |
|--|--------------|--|------------|------------------------|----------|---|----------|----------|----------|----------|----------|----------|-----------|-----------|-----------|
| LOW BACK CHAIR / OPEN WOOD UPHOLSTERED ARM  | | Overall: 24.5"w 26"d 37"-40"h | | Arm: 27"-30"h | | COM: 2.5 yds. | | | | | | | | | |
| | | Seat: 21"w 18"d 18"-21"h | | Weight: 60 lbs. | | COL: 45 sq.ft. | | | | | | | | | |
| | | COM | COL | 1 | 2 | 3 | 4 | 5 | 6 | 7 | 8 | 9 | 10 | L1 | L2 |
| | 450-2 | 1561 | 1718 | 1702 | 1772 | 1842 | 1912 | 1982 | 2052 | 2122 | 2192 | 2262 | 2333 | 2441 | 2694 |
| | | <i>Tilt Swivel w/ Lock / Pneumatic Seat Height Adjustment / 350 lb. Weight Capacity</i> | | | | | | | | | | | | | |
| | 450-4 | 1618 | 1779 | 1758 | 1828 | 1898 | 1968 | 2038 | 2108 | 2178 | 2248 | 2319 | 2389 | 2497 | 2750 |
| | | <i>Knee Tilt Swivel w/ Infinite Lock / Pneumatic Seat Height Adjustment / 350 lb. Weight Capacity</i> | | | | | | | | | | | | | |
| LOW BACK JURY CHAIR / OPEN WOOD UPHOLSTERED ARM  | | Overall: 24.5"w 26"d 37"-40"h | | Arm: 27"-30"h | | COM: 2.5 yds. | | | | | | | | | |
| | | Seat: 21"w 18"d 18"-21"h | | Weight: 60 lbs. | | COL: 45 sq.ft. | | | | | | | | | |
| | | COM | COL | 1 | 2 | 3 | 4 | 5 | 6 | 7 | 8 | 9 | 10 | L1 | L2 |
| | 450-5 | 1573 | 1730 | 1713 | 1783 | 1853 | 1923 | 1993 | 2063 | 2133 | 2204 | 2274 | 2344 | 2516 | 2768 |
| | | <i>Jury Base / Pneumatic Seat Height Adjustment / Self-Centering 360° Rotation / 350 lb. Weight Capacity</i> | | | | | | | | | | | | | |
| ARM CHAIR / OPEN WOOD ARM  | | Overall: 23.25"w 26"d 37"h | | Arm: 27"h | | COM: 2.5 yds. (455-P) / 3 yds. (455-T) | | | | | | | | | |
| | | Seat: 20"w 18"d 19"h | | Weight: 40 lbs. | | COL: 45 sq.ft. (455-P) / 54 sq.ft. (455-T) | | | | | | | | | |
| | | COM | COL | 1 | 2 | 3 | 4 | 5 | 6 | 7 | 8 | 9 | 10 | L1 | L2 |
| | 455-P | 1316 | 1448 | 1456 | 1527 | 1597 | 1667 | 1737 | 1807 | 1877 | 1947 | 2017 | 2087 | 2188 | 2440 |
| | | <i>Tight Seat & Back / 350 lb. Weight Capacity</i> | | | | | | | | | | | | | |

DESCRIPTION:

- Upholstery Frames: Hardwood & Plywood
- Seat: High Density Polyurethane Foam Over Woven Rubber Webbing
- Back: High Density Polyurethane Foam Over Polypropylene Webbing
- Classic Base Standard (451-2 & 451-4)
- 10 Year Warranty

OPTIONS:

Specify Exposed Wood Finish (See Page 6)
 Base & Caster Options Available (See Traditional Options Pages)
 Brass or Pewter Nail Head Trim (See Traditional Options Pages)

Note: Trinity Must Approve Specific Fabrics / Leathers Used For Tufting.

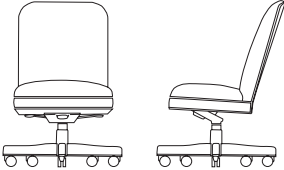
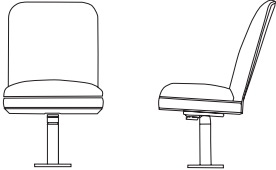
| RALEIGH | | ITEM #: | SPECIFICATIONS GRADES LIST PRICES: | | | | | | | | | | | | | | | | |
|--|--|---|---|--|---|------------|------------|----------|----------|----------|----------|----------|----------|----------|----------|----------|-----------|-----------|-----------|
|  | | LOW BACK ARMLESS CHAIR 451-2 451-4 | Overall: 24.5"w 26"d 37"-40"h Seat: 21"w 18"d 18"-21"h | Arm: n/a Weight: 60 lbs. | COM: 2.5 yds. COL: 45 sq.ft. | COM | COL | 1 | 2 | 3 | 4 | 5 | 6 | 7 | 8 | 9 | 10 | L1 | L2 |
| | | | 1281 1409 1435 1512 1590 1667 1744 1821 1898 1975 2052 2129 2243 2521 <i>Tilt Swivel w/ Lock / Pneumatic Seat Height Adjustment / 350 lb. Weight Capacity</i> | 1337 1471 1491 1568 1646 1723 1800 1877 1954 2031 2108 2185 2299 2577 <i>Knee Tilt Swivel w/ Infinite Lock / Pneumatic Seat Height Adjustment / 350 lb. Weight Capacity</i> | | | | | | | | | | | | | | | |
| | | | | | | | | | | | | | | | | | | | |
|  | | LOW BACK ARMLESS JURY CHAIR 451-5 | Overall: 24.5"w 26"d 37"-40"h Seat: 21"w 18"d 18"-21"h | Arm: n/a Weight: 60 lbs. | COM: 2.5 yds. COL: 45 sq.ft. | COM | COL | 1 | 2 | 3 | 4 | 5 | 6 | 7 | 8 | 9 | 10 | L1 | L2 |
| | | | 1292 1422 1447 1524 1601 1678 1755 1832 1909 1986 2063 2140 2254 2532 <i>Jury Base / Pneumatic Seat Height Adjustment / Self-Centering 360° Rotation / 350 lb. Weight Capacity</i> | | | | | | | | | | | | | | | | |
| | | | | | | | | | | | | | | | | | | | |

DESCRIPTION:

- Upholstery Frames: Hardwood & Plywood (Hardwood Only On #456)
- Seat: High Density Polyurethane Foam Over Woven Rubber Webbing
- Back: High Density Polyurethane Foam Over Polypropylene Webbing
- Upholstered Arms: Polyurethane Foam Over Hardwood
- Exposed Arms: Solid Maple, Lacquer Finished
- Nail Head Trim Optional (#456 Captain's Chair)
- 10 Year Warranty

OPTIONS:

Specify Exposed Wood Finish (See Page 6)
 Base & Caster Options Available (See Traditional Options Pages)
 Brass or Pewter Nail Head Trim (See Traditional Options Pages)

Note: Trinity Must Approve Specific Fabrics / Leathers Used For Tufting.

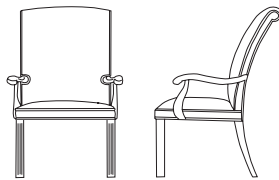
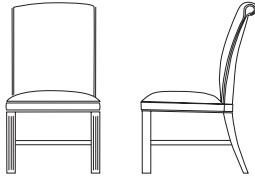
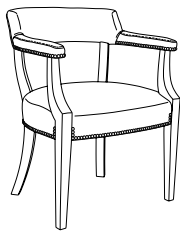
| YORK / CAPTAIN'S CHAIR | | ITEM #: | SPECIFICATIONS GRADES LIST PRICES: | | | | | | | | | | | | | | | | |
|---|-----|--|---|--|------|------|------|------|------|------|------|------|------|------|------|----|----|----|--|
| <p>ARM CHAIR / OPEN WOOD ARM</p>  | 452 | <p>Overall: 27.5"w 28"d 40"h</p> <p>Seat: 23"w 18.5"d 20"h</p> | <p>Arm: 26"h</p> <p>Weight: 45 lbs.</p> | <p>COM: 3 yds.</p> <p>COL: 54 sq.ft.</p> | COM | COL | 1 | 2 | 3 | 4 | 5 | 6 | 7 | 8 | 9 | 10 | L1 | L2 | |
| | | 1390 | 1529 | 1544 | 1621 | 1698 | 1775 | 1852 | 1929 | 2006 | 2084 | 2161 | 2238 | 2336 | 2614 | | | | |
| | | Tight Seat & Back / 350 lb. Weight Capacity | | | | | | | | | | | | | | | | | |
| <p>ARMLESS SIDE CHAIR</p>  | 453 | <p>Overall: 22"w 28"d 40"h</p> <p>Seat: 22"w 18.5"d 20"h</p> | <p>Arm: n/a</p> <p>Weight: 40 lbs.</p> | <p>COM: 3 yds.</p> <p>COL: 54 sq.ft.</p> | COM | COL | 1 | 2 | 3 | 4 | 5 | 6 | 7 | 8 | 9 | 10 | L1 | L2 | |
| | | 1096 | 1206 | 1251 | 1328 | 1405 | 1482 | 1559 | 1636 | 1713 | 1790 | 1867 | 1945 | 2042 | 2320 | | | | |
| | | Tight Seat & Back / 350 lb. Weight Capacity | | | | | | | | | | | | | | | | | |
| <p>CAPTAIN'S CHAIR</p>  <p>Brass Or Pewter Nail Head Trim Optional</p> | 456 | <p>Overall: 27"w 24"d 32"h</p> <p>Seat: 20"w 19"d 18"h</p> | <p>Arm: 27"h</p> <p>Weight: 40 lbs.</p> | <p>COM: 2 yds.</p> <p>COL: 39 sq.ft.</p> | COM | COL | 1 | 2 | 3 | 4 | 5 | 6 | 7 | 8 | 9 | 10 | L1 | L2 | |
| | | 940 | 1034 | 1020 | 1061 | 1101 | 1141 | 1181 | 1221 | 1261 | 1301 | 1341 | 1381 | 1450 | 1594 | | | | |
| | | Tight Seat & Back / 350 lb. Weight Capacity | | | | | | | | | | | | | | | | | |

DESCRIPTION:

- Upholstery Frames: Hardwood & Plywood
- Seat: High Density Polyurethane Foam Over Eight-Way Hand Tied Coil Springs
- Back: High Density Polyurethane Foam Over Sinuous Wire Springs
- Upholstered Arms: Polyurethane Foam Over Hardwood
- Exposed Legs: Solid Cherry, Lacquer Finished
- 10 Year Warranty

OPTIONS:

- Feather Down & Polyester Pillows Available (See Page 5)
- Specify Exposed Wood Finish (See Page 6)
- Brass or Pewter Nail Head Trim (See Traditional Options Pages)

Note: Trinity Must Approve Specific Fabrics / Leathers Used For Tufting.

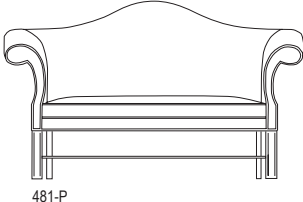
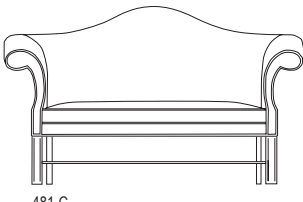
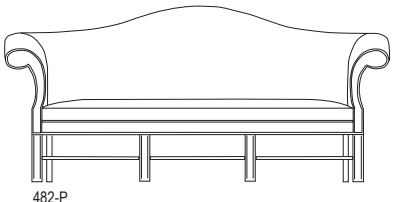
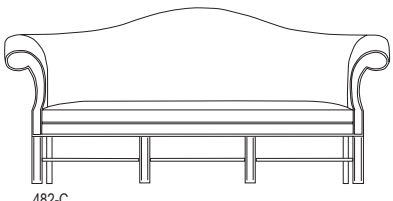
| RICHMOND | | ITEM #: | SPECIFICATIONS GRADES LIST PRICES: | | | | | | | | | | | | | |
|---|--|--------------|--|------------|----------|-------------------------|----------|----------|--|----------|----------|----------|----------|-----------|-----------|-----------|
| TWO PLACE SOFA / STRAIGHT FLUTED LEG | | | Overall: 59"w 34"d 35.5"h | | | Arm: 32"h | | | COM: 7 yds. (481-P) / 8 yds. (481-C) / 7.5 yds. (481-T) | | | | | | | |
| | | | Seat: 44"w 20.5"d 18"h | | | Weight: 105 lbs. | | | COL: 126 sq.ft. (481-P) / 144 sq.ft. (481-C) / 135 sq.ft. (481-T) | | | | | | | |
| | | | COM | COL | 1 | 2 | 3 | 4 | 5 | 6 | 7 | 8 | 9 | 10 | L1 | L2 |
|  | | 481-P | 2422 | 2569 | 2754 | 2964 | 3173 | 3382 | 3591 | 3801 | 4010 | 4219 | 4428 | 4638 | 4890 | 5643 |
| | | | <i>Tight Seat & Back / 750 lb. Weight Capacity</i> | | | | | | | | | | | | | |
|  | | 481-C | 2337 | 2478 | 2701 | 2924 | 3148 | 3372 | 3595 | 3819 | 4043 | 4266 | 4490 | 4714 | 5173 | 5978 |
| | | | <i>Reversible Loose Cushion / Tight Back / 750 lb. Weight Capacity</i> | | | | | | | | | | | | | |
| THREE PLACE SOFA / STRAIGHT FLUTED LEG | | | Overall: 88"w 34"d 38.5"h | | | Arm: 32"h | | | COM: 9 yds. (482-P) / 10.75 yds. (482-C) / 9.75 yds. (482-T) | | | | | | | |
| | | | Seat: 73"w 20.5"d 18"h | | | Weight: 140 lbs. | | | COL: 162 sq.ft. (482-P) / 193.5 sq.ft. (482-C) / 175.5 sq.ft. (482-T) | | | | | | | |
| | | | COM | COL | 1 | 2 | 3 | 4 | 5 | 6 | 7 | 8 | 9 | 10 | L1 | L2 |
|  | | 482-P | 3109 | 3298 | 3532 | 3799 | 4066 | 4333 | 4600 | 4867 | 5134 | 5401 | 5668 | 5935 | 6248 | 7210 |
| | | | <i>Tight Seat & Back / 750 lb. Weight Capacity</i> | | | | | | | | | | | | | |
|  | | 482-C | 2893 | 3069 | 3382 | 3678 | 3973 | 4269 | 4565 | 4861 | 5157 | 5453 | 5749 | 6044 | 6800 | 7865 |
| | | | <i>Reversible Loose Cushion / Tight Back / 750 lb. Weight Capacity</i> | | | | | | | | | | | | | |

DESCRIPTION:

- Upholstery Frames: Hardwood & Plywood
- Seat: High Density Polyurethane Foam Over Eight-Way Hand Tied Coil Springs
- Back: High Density Polyurethane Foam Over Sinuous Wire Springs
- Loose Cushions: High Density Polydacron
- Integral Exposed Wood Legs: Solid Cherry
- Leather / Vinyl Cushions Are Not Reversible
- 10 Year Warranty

OPTIONS:

PM1 Power/Data Module (1-Power / 1-USB 2 Port Simplex Charger)\$859
 (Additional Power/Data Modules Available - See Traditional Options)

Feather Down & Polyester Pillows Available (See Page 5)
 Specify Exposed Wood Finish (See Page 6)
 Brass or Pewter Nail Head Trim (See Traditional Options Pages)

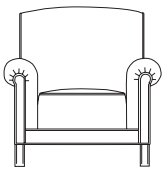
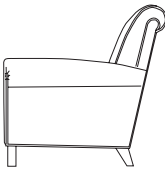
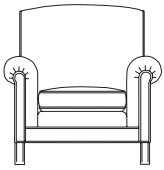
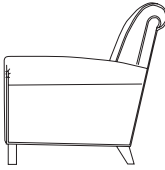
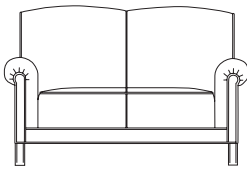
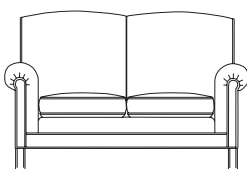
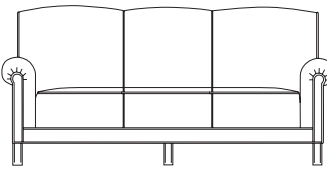
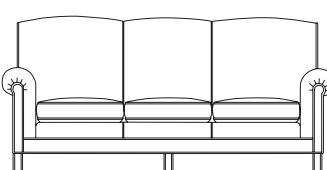
| DAVENPORT | | ITEM #: | SPECIFICATIONS GRADES LIST PRICES: | | | | | | | | | | | | | |
|---|--|--------------|---|------------|----------|-------------------------|----------|----------|---|----------|----------|----------|----------|-----------|-----------|-----------|
| LOUNGE CHAIR | | | Overall: 34.5"w 37"d 34.5"h | | | Arm: 24"h | | | COM: 5 yds. (486-P) / 5.5 yds. (486-C) | | | | | | | |
| | | | Seat: 21.5"w 21"d 18"h | | | Weight: 75 lbs. | | | COL: 90 sq.ft. (486-P) / 99 sq.ft. (486-C) | | | | | | | |
| | | | COM | COL | 1 | 2 | 3 | 4 | 5 | 6 | 7 | 8 | 9 | 10 | L1 | L2 |
|   | | 486-P | 1698 | 1867 | 1978 | 2118 | 2258 | 2399 | 2539 | 2679 | 2819 | 2959 | 3100 | 3240 | 3429 | 3933 |
| | | | <i>Tight Seat & Back / 500 lb. Weight Capacity</i> | | | | | | | | | | | | | |
|   | | 486-C | 1662 | 1828 | 1984 | 2145 | 2307 | 2468 | 2629 | 2790 | 2951 | 3113 | 3274 | 3435 | 3707 | 4287 |
| | | | <i>Reversible Loose Seat Cushion / Tight Back / 500 lb. Weight Capacity</i> | | | | | | | | | | | | | |
| TWO PLACE SOFA | | | Overall: 65.5"w 37"d 34.5"h | | | Arm: 24"h | | | COM: 7.75 yds. (487-P) / 8.5 yds. (487-C) | | | | | | | |
| | | | Seat: 52.5"w 21"d 18"h | | | Weight: 110 lbs. | | | COL: 139.5 sq.ft. (487-P) / 153 sq.ft. (487-C) | | | | | | | |
| | | | COM | COL | 1 | 2 | 3 | 4 | 5 | 6 | 7 | 8 | 9 | 10 | L1 | L2 |
|  | | 487-P | 2485 | 2734 | 2920 | 3137 | 3354 | 3572 | 3789 | 4006 | 4223 | 4441 | 4658 | 4875 | 5156 | 5938 |
| | | | <i>Tight Seat & Back / 750 lb. Weight Capacity</i> | | | | | | | | | | | | | |
|  | | 487-C | 2099 | 2309 | 2562 | 2793 | 3024 | 3256 | 3487 | 3718 | 3950 | 4181 | 4412 | 4644 | 5273 | 6106 |
| | | | <i>Reversible Loose Seat Cushions / Tight Back / 750 lb. Weight Capacity</i> | | | | | | | | | | | | | |
| THREE PLACE SOFA | | | Overall: 82.5"w 37"d 34.5"h | | | Arm: 24"h | | | COM: 9 yds. (488-P) / 10 yds. (488-C) | | | | | | | |
| | | | Seat: 69.5"w 21"d 18"h | | | Weight: 160 lbs. | | | COL: 162 sq.ft. (488-P) / 180 sq.ft. (488-C) | | | | | | | |
| | | | COM | COL | 1 | 2 | 3 | 4 | 5 | 6 | 7 | 8 | 9 | 10 | L1 | L2 |
|  | | 488-P | 3051 | 3356 | 3541 | 3787 | 4032 | 4277 | 4523 | 4768 | 5013 | 5259 | 5504 | 5749 | 6070 | 6954 |
| | | | <i>Tight Seat & Back / 1000 lb. Weight Capacity</i> | | | | | | | | | | | | | |
|  | | 488-C | 2621 | 2883 | 3167 | 3441 | 3714 | 3987 | 4261 | 4534 | 4808 | 5081 | 5354 | 5628 | 6527 | 7511 |
| | | | <i>Reversible Loose Seat Cushions / Tight Back / 1000 lb. Weight Capacity</i> | | | | | | | | | | | | | |

DESCRIPTION:

- Upholstery Frames: Hardwood & Plywood
- Seat: High Density Polyurethane Foam Over Eight-Way Hand Tied Coil Springs
- Back: High Density Polyurethane Foam Over Sinuous Wire Springs
- Loose Cushions: High Density Polydacron
- Integral Exposed Wood Legs: Solid Cherry
- Leather / Vinyl Cushions Are Not Reversible
- Brass Ferrules Standard
- 10 Year Warranty

OPTIONS:

PM1 Power/Data Module (1-Power / 1-USB 2 Port Simplex Charger)\$859
 (Additional Power/Data Modules Available - See Traditional Options)

Feather Down & Polyester Pillows Available (See Page 5)
 Specify Exposed Wood Finish (See Page 6)
 Brass Nail Head Trim (See Traditional Options Pages)

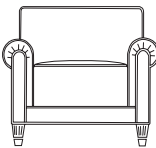
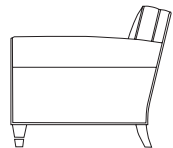
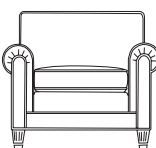
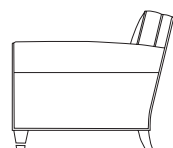
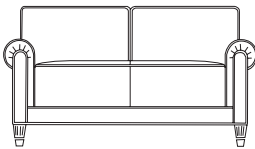
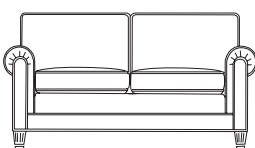
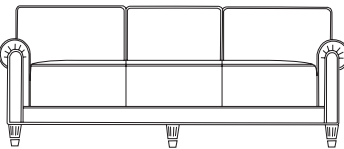
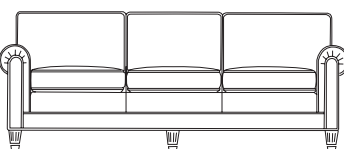
| RANDOLPH | | ITEM #: | SPECIFICATIONS GRADES LIST PRICES: | | | | | | | | | | | | | |
|---|--|--------------|--|------------|----------|-------------------------|----------|----------|---|----------|----------|----------|----------|-----------|-----------|-----------|
| LOUNGE CHAIR | | | Overall: 35"w 34"d 31"h | | | Arm: 23"h | | | COM: 4.75 yds. (490-P) / 5.25 yds. (490-C) | | | | | | | |
| | | | Seat: 21.5"w 20.5"d 17.5"h | | | Weight: 65 lbs. | | | COL: 85.5 sq.ft. (490-P) / 94.5 sq.ft. (490-C) | | | | | | | |
|   | | 490-P | COM | COL | 1 | 2 | 3 | 4 | 5 | 6 | 7 | 8 | 9 | 10 | L1 | L2 |
| | | | 1901 | 2091 | 2167 | 2301 | 2434 | 2567 | 2700 | 2833 | 2967 | 3100 | 3233 | 3366 | 3562 | 4041 |
| | | | <i>Tight Seat & Back / 500 lb. Weight Capacity</i> | | | | | | | | | | | | | |
|   | | 490-C | 1943 | 2138 | 2238 | 2385 | 2532 | 2679 | 2827 | 2974 | 3121 | 3268 | 3415 | 3563 | 3777 | 4307 |
| | | | <i>Reversible Loose Seat Cushion / Tight Back / 500 lb. Weight Capacity</i> | | | | | | | | | | | | | |
| | | | <i>Brass Nail Head Trim Available On Arm Fronts Only</i> | | | | | | | | | | | | | |
| TWO PLACE SOFA | | | Overall: 58.5"w 34"d 31"h | | | Arm: 23"h | | | COM: 6.75 yds. (491-P) / 7.25 yds. (491-C) | | | | | | | |
| | | | Seat: 44"w 20.5"d 17.5"h | | | Weight: 100 lbs. | | | COL: 121.5 sq.ft. (491-P) / 130.5 sq.ft. (491-C) | | | | | | | |
|  | | 491-P | COM | COL | 1 | 2 | 3 | 4 | 5 | 6 | 7 | 8 | 9 | 10 | L1 | L2 |
| | | | 2522 | 2774 | 2901 | 3090 | 3279 | 3468 | 3658 | 3847 | 4036 | 4225 | 4415 | 4604 | 4869 | 5550 |
| | | | <i>Tight Seat & Back / 750 lb. Weight Capacity</i> | | | | | | | | | | | | | |
|  | | 491-C | 2606 | 2867 | 3027 | 3237 | 3447 | 3658 | 3868 | 4078 | 4288 | 4499 | 4709 | 4919 | 5218 | 5975 |
| | | | <i>Reversible Loose Seat Cushion / Tight Back / 750 lb. Weight Capacity</i> | | | | | | | | | | | | | |
| | | | <i>Brass Nail Head Trim Available On Arm Fronts Only</i> | | | | | | | | | | | | | |
| THREE PLACE SOFA | | | Overall: 78.5"w 34"d 31"h | | | Arm: 23"h | | | COM: 8 yds. (492-P) / 9.5 yds. (492-C) | | | | | | | |
| | | | Seat: 64"w 20.5"d 17.5"h | | | Weight: 147 lbs. | | | COL: 144 sq.ft. (492-P) / 171 sq.ft. (492-C) | | | | | | | |
|  | | 492-P | COM | COL | 1 | 2 | 3 | 4 | 5 | 6 | 7 | 8 | 9 | 10 | L1 | L2 |
| | | | 3198 | 3518 | 3647 | 3871 | 4095 | 4320 | 4544 | 4768 | 4993 | 5217 | 5441 | 5666 | 5979 | 6786 |
| | | | <i>Tight Seat & Back / 1000 lb. Weight Capacity</i> | | | | | | | | | | | | | |
|  | | 492-C | 3348 | 3682 | 3866 | 4126 | 4385 | 4644 | 4904 | 5163 | 5423 | 5682 | 5941 | 6201 | 6565 | 7499 |
| | | | <i>Reversible Loose Seat Cushion / Tight Back / 1000 lb. Weight Capacity</i> | | | | | | | | | | | | | |
| | | | <i>Brass Nail Head Trim Available On Arm Fronts Only</i> | | | | | | | | | | | | | |

DESCRIPTION:

- Upholstery Frames: Hardwood & Plywood
- Seat: High Density Polyurethane Foam Over Eight-Way Hand Tied Coil Springs
- Back: High Density Polyurethane Foam Over Sinuous Wire Springs
- Loose Cushions: High Density Polydacron
- Integral Exposed Wood Legs: Solid Cherry
- Leather / Vinyl Cushions Are Not Reversible
- Brass Nail Head Trim / Brass Ferrules Standard
- 10 Year Warranty

OPTIONS:







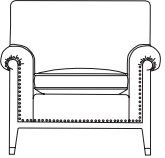
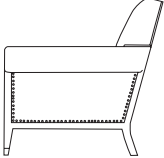
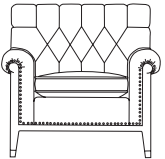
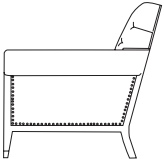
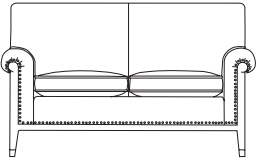
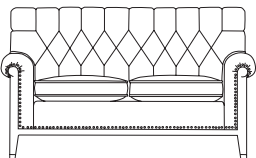
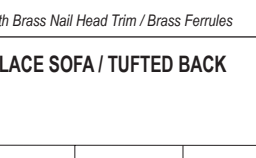
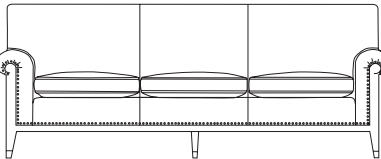
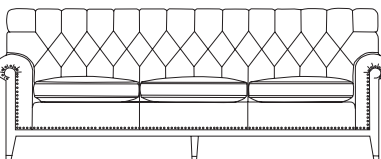

PM1 Power/Data Module (1-Power / 1-USB 2 Port Simplex Charger)\$859
 (Additional Power/Data Modules Available - See Traditional Options)





Feather Down & Polyester Pillows Available (See Page 5)
 Specify Exposed Wood Finish (See Page 6)

Note: Trinity Must Approve Specific Fabrics / Leathers Used For Tufting.

| RAYBURN | | ITEM #: | SPECIFICATIONS GRADES LIST PRICES: | | | | | | | | | | | | | | |
|--|--|--------------|--|------------|----------|-------------------------|----------|----------|--|----------|----------|----------|----------|-----------|-----------|-----------|--|
| LOUNGE CHAIR / TUFTED BACK | | | Overall: 34.5"w 34"d 34"h | | | Arm: 23"h | | | COM: 4.75 yds. (493-P) / 6.25 yds. (493-C) / 6.5 yds. (493-T) | | | | | | | | |
| | | | Seat: 21.5"w 20"d 18"h | | | Weight: 65 lbs. | | | COL: 85.5 sq.ft. (493-P) / 112.5 sq.ft. (493-C) / 117 sq.ft. (493-T) | | | | | | | | |
| | | | COM | COL | 1 | 2 | 3 | 4 | 5 | 6 | 7 | 8 | 9 | 10 | L1 | L2 | |
|  493-C | | 493-C | 2116 | 2327 | 2424 | 2579 | 2733 | 2887 | 3041 | 3195 | 3350 | 3504 | 3658 | 3812 | 4165 | 4721 | |
| | | | <i>Reversible Loose Seat Cushion / Tight Back / 500 lb. Weight Capacity</i> | | | | | | | | | | | | | | |
|  493-T | | 493-T | 2412 | 2653 | 2721 | 2875 | 3029 | 3183 | 3337 | 3492 | 3646 | 3800 | 3954 | 4109 | 4331 | 4886 | |
| | | | <i>Reversible Loose Seat Cushion / Tufted Back / 500 lb. Weight Capacity</i> | | | | | | | | | | | | | | |
|  493-C | | | | | | | | | | | | | | | | | |
|  493-T | | | | | | | | | | | | | | | | | |
| Standard With Brass Nail Head Trim / Brass Ferrules | | | | | | | | | | | | | | | | | |
| TWO PLACE SOFA / TUFTED BACK | | | Overall: 64"w 34"d 34"h | | | Arm: 23"h | | | COM: 6.5 yds. (494-P) / 8 yds. (494-C) / 8.75 yds. (494-T) | | | | | | | | |
| | | | Seat: 51"w 20"d 18"h | | | Weight: 100 lbs. | | | COL: 117 sq.ft. (494-P) / 144 sq.ft. (494-C) / 157.5 sq.ft. (494-T) | | | | | | | | |
| | | | COM | COL | 1 | 2 | 3 | 4 | 5 | 6 | 7 | 8 | 9 | 10 | L1 | L2 | |
|  494-C | | 494-C | 2716 | 2987 | 3151 | 3368 | 3585 | 3802 | 4020 | 4237 | 4454 | 4672 | 4889 | 5106 | 5801 | 6583 | |
| | | | <i>Reversible Loose Seat Cushions / Tight Back / 750 lb. Weight Capacity</i> | | | | | | | | | | | | | | |
|  494-T | | 494-T | 3627 | 3990 | 4090 | 4321 | 4553 | 4784 | 5015 | 5247 | 5478 | 5709 | 5941 | 6172 | 6522 | 7354 | |
| | | | <i>Reversible Loose Seat Cushions / Tufted Back / 750 lb. Weight Capacity</i> | | | | | | | | | | | | | | |
|  494-T | | | | | | | | | | | | | | | | | |
| Standard With Brass Nail Head Trim / Brass Ferrules | | | | | | | | | | | | | | | | | |
| THREE PLACE SOFA / TUFTED BACK | | | Overall: 89"w 34"d 34"h | | | Arm: 23"h | | | COM: 9.25 yds. (495-P) / 10.25 yds. (495-C) / 11 yds. (495-T) | | | | | | | | |
| | | | Seat: 76"w 20"d 18"h | | | Weight: 170 lbs. | | | COL: 166.5 sq.ft. (495-P) / 184.5 sq.ft. (495-C) / 198 sq.ft. (495-T) | | | | | | | | |
| | | | COM | COL | 1 | 2 | 3 | 4 | 5 | 6 | 7 | 8 | 9 | 10 | L1 | L2 | |
|  495-C | | 495-C | 3350 | 3685 | 3896 | 4170 | 4443 | 4716 | 4990 | 5263 | 5537 | 5810 | 6083 | 6357 | 7454 | 8438 | |
| | | | <i>Reversible Loose Seat Cushions / Tight Back / 1000 lb. Weight Capacity</i> | | | | | | | | | | | | | | |
|  495-T | | 495-T | 4791 | 5270 | 5394 | 5695 | 5997 | 6298 | 6600 | 6901 | 7203 | 7504 | 7805 | 8107 | 8579 | 9664 | |
| | | | <i>Reversible Loose Seat Cushions / Tufted Back / 1000 lb. Weight Capacity</i> | | | | | | | | | | | | | | |
| 495-T | | | | | | | | | | | | | | | | | |
| Standard With Brass Nail Head Trim / Brass Ferrules | | | | | | | | | | | | | | | | | |

| BASES | OPTION #: | SPECIFICATIONS LIST PRICES AVAILABILITY: | | | | | | | | |
|---|------------------|--|-----------------------------------|------------------|--|------------------|---|-----------------|-----------------------|------------------|
| <p>TRANSITIONAL WOOD BASE</p>  | <p>TWB</p> | <p>Overall: 25"w 25"d 5.5"h</p> <hr/> <p>No Charge Solid Hardwood Cap, Steel Reinforced 5 Prong Base With 55mm Black Dual Wheel Casters.</p> <p>OPTIONS:</p> <table border="0"> <tr> <td>C1 Carpet Caster - 2" Metal Balls</td> <td>\$164 (Set Of 5)</td> </tr> <tr> <td>C2 Antique Bronze Hooded Caster - 2" Rubber Ball</td> <td>\$151 (Set Of 5)</td> </tr> <tr> <td>C3 Brass Hooded Black Caster - 2" Dual Wheels</td> <td>\$84 (Set Of 5)</td> </tr> </table> <p>Available: Traditional Executive Seating</p> | C1 Carpet Caster - 2" Metal Balls | \$164 (Set Of 5) | C2 Antique Bronze Hooded Caster - 2" Rubber Ball | \$151 (Set Of 5) | C3 Brass Hooded Black Caster - 2" Dual Wheels | \$84 (Set Of 5) | | |
| C1 Carpet Caster - 2" Metal Balls | \$164 (Set Of 5) | | | | | | | | | |
| C2 Antique Bronze Hooded Caster - 2" Rubber Ball | \$151 (Set Of 5) | | | | | | | | | |
| C3 Brass Hooded Black Caster - 2" Dual Wheels | \$84 (Set Of 5) | | | | | | | | | |
| <p>CLASSIC WOOD BASE</p>  | <p>CWB</p> | <p>Overall: 28"w 28"d 5"h</p> <hr/> <p>Standard Traditional Base - No Charge Solid Hardwood Cap, Steel Reinforced 5 Prong Base With 55mm Black Dual Wheel Casters.</p> <p>OPTIONS:</p> <table border="0"> <tr> <td>C1 Carpet Caster - 2" Metal Balls</td> <td>\$164 (Set Of 5)</td> </tr> <tr> <td>C2 Antique Bronze Hooded Caster - 2" Rubber Ball</td> <td>\$151 (Set Of 5)</td> </tr> <tr> <td>C3 Brass Hooded Black Caster - 2" Dual Wheels</td> <td>\$84 (Set Of 5)</td> </tr> <tr> <td>SP Brass Scuff Plates</td> <td>\$121 (Set Of 5)</td> </tr> </table> <p>Available: Traditional Executive Seating</p> | C1 Carpet Caster - 2" Metal Balls | \$164 (Set Of 5) | C2 Antique Bronze Hooded Caster - 2" Rubber Ball | \$151 (Set Of 5) | C3 Brass Hooded Black Caster - 2" Dual Wheels | \$84 (Set Of 5) | SP Brass Scuff Plates | \$121 (Set Of 5) |
| C1 Carpet Caster - 2" Metal Balls | \$164 (Set Of 5) | | | | | | | | | |
| C2 Antique Bronze Hooded Caster - 2" Rubber Ball | \$151 (Set Of 5) | | | | | | | | | |
| C3 Brass Hooded Black Caster - 2" Dual Wheels | \$84 (Set Of 5) | | | | | | | | | |
| SP Brass Scuff Plates | \$121 (Set Of 5) | | | | | | | | | |
| <p>TAPERED RESIN BASE</p>  | <p>TRB</p> | <p>Overall: 25.5"w 25.5"d 5"h</p> <hr/> <p>\$47 Deduct Black Reinforced Nylon 5 Prong Base With 55mm Black Dual Wheel Casters.</p> <p>Available: Traditional Executive Seating</p> | | | | | | | | |
| <p>JURY BASE</p>  | <p>JRB</p> | <p>Overall: 8.5" Diameter 3.75"h</p> <hr/> <p>\$200 360° Rotation, Self Centering With Pneumatic Height Adjustment</p> <p>OPTIONS: No Rotation</p> <p>Available: Traditional Executive Seating</p> | | | | | | | | |

| CASTERS / SCUFF PLATES / NAIL TRIM / MEDALLIONS | OPTION #: | SPECIFICATIONS LIST PRICES AVAILABILITY: |
|---|---|--|
| <p>CASTERS</p>  <p>(C1) Carpet Caster - 2" Metal Balls</p>  <p>(C2) Antique Bronze Hooded Caster - 2" Rubber Ball</p>  <p>(C3) Brass Hooded Black Caster - 2" Dual Wheels</p>  <p>(C4) Black Sculptured Glide - 2" Flat Bottom Glide</p> | <p>Overall: 2"h</p> <p>C1 \$200 (Set Of 5) <i>Carpet Caster - 2" Metal Balls - Antique Windsor (Additional Finishes Available)</i></p> <p>C2 \$152 (Set Of 5) <i>Antique Bronze Hooded Caster - 2" Rubber Ball (Additional Finishes Available)</i></p> <p>C3 \$95 (Set Of 5) <i>Brass Hooded Black Caster - 2" Dual Wheels (Additional Finishes Available)</i></p> <p>C4 No Charge (Set Of 5) <i>Black Sculptured Glide - 2" Flat Bottom Glide</i></p> <p>C5 \$105 (Set Of 5) <i>Polished Aluminum Hooded Caster - 2" Dual Wheels</i></p> <p>Available: <i>Traditional Executive Seating</i></p>  <p>(C5) Polished Aluminum Caster - 2" Dual Wheels</p> | |
| <p>SCUFF PLATES</p>  | <p>Overall: 1"w 4"d</p> <p>SP \$121 (Set Of 5) <i>(Specify Brass Or Pewter)</i></p> <p>Available: <i>Classic Base Only</i></p> | |
| <p>NAIL HEAD TRIM</p>  | <p>Overall: .4375" Diameter</p> <p>NT-1 \$78 - Guest Chair <i>#9 French Natural Brass Standard. Pewter Nail Trim Is Available. (Specify Finish) NOTE: All Trim Is Placed Head To Head.</i></p> <p>NT-2 \$88 - Lounge Chair <i>#9 French Natural Brass Standard. Pewter Nail Trim Is Available. (Specify Finish) NOTE: All Trim Is Placed Head To Head.</i></p> <p>NT-3 \$113 - Executive Chair, Wing Back Chairs, Two Place Sofa (Love Seat) <i>#9 French Natural Brass Standard. Pewter Nail Trim Is Available. (Specify Finish) NOTE: All Trim Is Placed Head To Head.</i></p> <p>NT-4 \$147 - Three Place Sofa <i>#9 French Natural Brass Standard. Pewter Nail Trim Is Available. (Specify Finish) NOTE: All Trim Is Placed Head To Head.</i></p> <p>Available: <i>Traditional Executive, Guest, Lounge</i></p> | |
| <p>CONCENTRIC CIRCLE ARM MEDALLIONS</p>  | <p>Overall: 1.25" Diameter</p> <p>CCM No Charge <i>(Specify Finish)</i></p> <p>Available: <i>Traditional Executive Chairs</i></p> | |

| POWER / COVERS | OPTION #: | SPECIFICATIONS LIST PRICES AVAILABILITY: |
|--|---|--|
| <p>POWER / DATA MODULE</p>  <p>PM1 Power / Data Module</p>  <p>PM2 Power Module</p>  <p>USB-1 Dual Charging USB</p> | <p>PM1</p> <p>PM2</p> <p>USB-1</p> | <p>PM1 Overall: 5.25"w 1.25"d 4.25"h PM2 Overall: 2"w 2"d .125"h USB-1 Overall: 2"w 2"d .125"h</p> <p>\$859 Power/Data Module (1-Power / 1-USB 2 Port Simplex Charger Standard) <i>Vertical / Horizontal Mount Power Module. Price Varies By Socket. Contact Customer Service For Quote. (Additional Colors Available)</i></p> <p>\$238 Power Module (1-Power) <i>Spill-Proof Technology / Multiple Finish Options / Storm Color Standard (Specify Left or Right Facing)</i></p> <p>\$238 Dual Charging USB (2 Port Simplex Charger Standard) <i>Spill-Proof Technology / 2 Amps Per Port / Multiple Finish Options / Storm Color Standard (Specify Left or Right Facing)</i></p> <p>Available: Traditional Lounge</p> |
| <p>CONTRASTING COVERS</p>  | <p>CC</p> | <p>Overall: n/a</p> <p>\$129 <i>NOTE: If Two Or More Upholsteries Or Leathers Are Used On Any Piece Of Furniture, Then A Contrast Charge Will Apply Per Order. When Using Trinity Upholstery, The Higher Priced Upholstery Grade Will Be Used In Pricing, Unless It's Trinity Leather With Fabric Contrast Welt, Or COM With Trinity Contrast Welt, Then Contact Customer Service For Pricing.</i></p> <p>Available: Traditional Collection</p> |

Conrad

EXECUTIVE / GUEST

Effective: March 1, 2025

T R I N I T Y

Date:

Page:

Modification:

Description:

DESCRIPTION:

- Upholstery Frames: Plywood & Hardwood
- Seat / Back: High Density Polyurethane Foam
- Arms: High Density Polyurethane Foam Over Plywood & Hardwood
- Exposed Wood Upholstered Arms & Exposed Wood Open Arms Have Exposed Solid Maple Front Posts Finished In Lacquer
- All Arms Attached & Reinforced w/ Steel
- Black Arched Resin Base Standard
- 10 Year Warranty

OPTIONS:

Specify Exposed Wood Finish (See Page 6)
Base & Caster Options Available (See Conrad Options Pages)

Note: Trinity Must Approve Specific Fabrics / Leathers Used For Tufting.

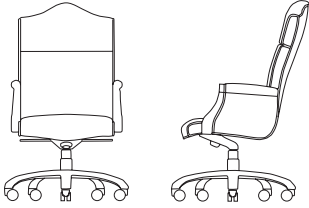
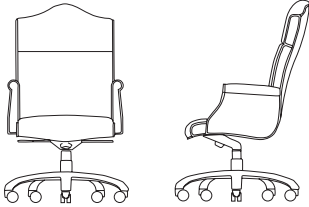
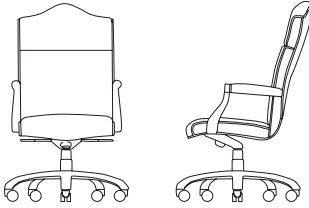
| EXECUTIVE | ITEM #: | SPECIFICATIONS GRADES LIST PRICES: | | | | | | | | | | | | | |
|---|---------------|---|------------|------------------------|----------|--|----------|----------|----------|----------|----------|----------|-----------|-----------|-----------|
|  | | Overall: 24.5"w 28"d 45"-48"h | | Arm: 25"-28"h | | COM: 3.25 yds. (500-2 / 500-4) / 3.5 yds. (500-2X) | | | | | | | | | |
| | | Seat: 20.5"w 20"d 17"-20"h | | Weight: 65 lbs. | | COL: 58.5 sq.ft. (500-2 / 500-4) / 63 sq.ft. (500-2X) | | | | | | | | | |
| | | COM | COL | 1 | 2 | 3 | 4 | 5 | 6 | 7 | 8 | 9 | 10 | L1 | L2 |
| | 500-2 | 1449 | 1593 | 1538 | 1622 | 1706 | 1790 | 1874 | 1958 | 2042 | 2127 | 2211 | 2295 | 2430 | 2733 |
| | | <i>Tilt Swivel / Pneumatic Seat Height Adjustment / 350 lb. Weight Capacity</i> | | | | | | | | | | | | | |
| | 500-2X | 1603 | 1763 | 1698 | 1789 | 1880 | 1971 | 2062 | 2153 | 2244 | 2335 | 2427 | 2518 | 2658 | 2986 |
| | | <i>Heavy Duty Construction / Overall Size Increased: W + 1.5", D + 1.5" / Tilt Swivel / Pneumatic Seat Height Adjustment / 350 lb. Wt. Capacity</i> | | | | | | | | | | | | | |
| | 500-4 | 1496 | 1646 | 1583 | 1667 | 1751 | 1835 | 1919 | 2003 | 2087 | 2171 | 2256 | 2340 | 2475 | 2777 |
| | | <i>Knee Tilt Swivel w/ Infinite Lock / Pneumatic Seat Height Adjustment / 350 lb. Weight Capacity</i> | | | | | | | | | | | | | |
|  | | Overall: 26"w 28"d 45"-48"h | | Arm: 25"-28"h | | COM: 3.5 yds. (501-2 / 501-4) / 3.5 yds. (501-2X) | | | | | | | | | |
| | | Seat: 20.5"w 20"d 17"-20"h | | Weight: 65 lbs. | | COL: 63 sq.ft. (501-2 / 501-4) / 63 sq.ft. (501-2X) | | | | | | | | | |
| | | COM | COL | 1 | 2 | 3 | 4 | 5 | 6 | 7 | 8 | 9 | 10 | L1 | L2 |
| | 501-2 | 1302 | 1432 | 1413 | 1504 | 1595 | 1686 | 1777 | 1868 | 1960 | 2051 | 2142 | 2233 | 2376 | 2704 |
| | | <i>Tilt Swivel / Pneumatic Seat Height Adjustment / 350 lb. Weight Capacity</i> | | | | | | | | | | | | | |
| | 501-2X | 1462 | 1608 | 1564 | 1655 | 1746 | 1838 | 1929 | 2020 | 2111 | 2202 | 2293 | 2384 | 2527 | 2855 |
| | | <i>Heavy Duty Construction / Overall Size Increased: W + 1.5", D + 1.5" / Tilt Swivel / Pneumatic Seat Height Adjustment / 350 lb. Wt. Capacity</i> | | | | | | | | | | | | | |
| | 501-4 | 1367 | 1503 | 1474 | 1566 | 1657 | 1748 | 1839 | 1930 | 2021 | 2112 | 2204 | 2295 | 2437 | 2766 |
| | | <i>Knee Tilt Swivel w/ Infinite Lock / Pneumatic Seat Height Adjustment / 350 lb. Weight Capacity</i> | | | | | | | | | | | | | |
|  | | Overall: 24.5"w 28"d 45"-48"h | | Arm: 25"-28"h | | COM: 2.75 yds. | | | | | | | | | |
| | | Seat: 20.5"w 20"d 17"-20"h | | Weight: 65 lbs. | | COL: 49.5 sq.ft. | | | | | | | | | |
| | | COM | COL | 1 | 2 | 3 | 4 | 5 | 6 | 7 | 8 | 9 | 10 | L1 | L2 |
| | 502-2 | 1333 | 1467 | 1401 | 1471 | 1541 | 1611 | 1681 | 1751 | 1821 | 1891 | 1962 | 2032 | 2149 | 2401 |
| | | <i>Tilt Swivel / Pneumatic Seat Height Adjustment / 350 lb. Weight Capacity</i> | | | | | | | | | | | | | |
| | 502-4 | 1399 | 1538 | 1462 | 1533 | 1603 | 1673 | 1743 | 1813 | 1883 | 1953 | 2023 | 2093 | 2211 | 2463 |
| | | <i>Knee Tilt Swivel w/ Infinite Lock / Pneumatic Seat Height Adjustment / 350 lb. Weight Capacity</i> | | | | | | | | | | | | | |

DESCRIPTION:

- Upholstery Frames: Plywood & Hardwood
- Seat / Back: High Density Polyurethane Foam
- Arms: High Density Polyurethane Foam Over Plywood & Hardwood
- Exposed Wood Upholstered Arms & Exposed Wood Open Arms Have Exposed Solid Maple Front Posts Finished In Lacquer
- All Arms Attached & Reinforced w/ Steel
- Task Arm Has Black Urethane Pad & Adjusts Vertically
- Black Arched Resin Base Standard
- 10 Year Warranty

OPTIONS:

Specify Exposed Wood Finish (See Page 6)
Base & Caster Options Available (See Conrad Options Pages)

| EXECUTIVE | ITEM #: | SPECIFICATIONS GRADES LIST PRICES: | | | | | | | | | | | | | | | | |
|-----------|---|--|---|--|---|------------|------------|----------|----------|----------|----------|----------|----------|----------|----------|--|-----------|-----------|
| | HIGH BACK CHAIR / EXPOSED WOOD UPHOLSTERED ARM / VERTICAL CHANNEL BACK | Overall: 25"w 28"d 45"-48"h Seat: 20.5"w 20"d 17"-20"h | Arm: 25"-28"h Weight: 65 lbs. | COM: 3.5 yds. (510-2 / 510-4) / 3.5 yds. (510-2X) COL: 63 sq.ft. (510-2 / 510-4) / 63 sq.ft. (510-2X) | COM | COL | 1 | 2 | 3 | 4 | 5 | 6 | 7 | 8 | 9 | 10 | L1 | L2 |
| | 510-2 | 1410 | 1551 | 1516 | 1607 | 1698 | 1789 | 1880 | 1971 | 2062 | 2154 | 2245 | 2336 | 2471 | 2799 | Tilt Swivel / Pneumatic Seat Height Adjustment / 350 lb. Weight Capacity | | |
| | 510-2X | 1468 | 1615 | 1570 | 1661 | 1753 | 1844 | 1935 | 2026 | 2117 | 2208 | 2299 | 2390 | 2527 | 2855 | Heavy Duty Construction / Overall Size Increased: W + 1.5", D + 1.5" / Tilt Swivel / Pneumatic Seat Height Adjustment / 350 lb. Wt. Capacity | | |
| | 510-4 | 1470 | 1617 | 1572 | 1663 | 1754 | 1845 | 1936 | 2027 | 2119 | 2210 | 2301 | 2392 | 2527 | 2855 | Knee Tilt Swivel w/ Infinite Lock / Pneumatic Seat Height Adjustment / 350 lb. Weight Capacity | | |
| | HIGH BACK CHAIR / FULLY UPHOLSTERED ARM / VERTICAL CHANNEL BACK | Overall: 25"w 28"d 45"-48"h Seat: 20.5"w 20"d 17"-20"h | Arm: 25"-28"h Weight: 65 lbs. | COM: 3.25 yds. (511-2 / 511-4) / 3.25 yds. (511-2X) COL: 58.5 sq.ft. (511-2 / 511-4) / 58.5 sq.ft. (511-2X) | COM | COL | 1 | 2 | 3 | 4 | 5 | 6 | 7 | 8 | 9 | 10 | L1 | L2 |
| | 511-2 | 1278 | 1406 | 1377 | 1461 | 1545 | 1629 | 1713 | 1797 | 1881 | 1966 | 2050 | 2134 | 2266 | 2569 | Tilt Swivel / Pneumatic Seat Height Adjustment / 350 lb. Weight Capacity | | |
| | 511-2X | 1336 | 1469 | 1431 | 1515 | 1599 | 1684 | 1768 | 1852 | 1936 | 2020 | 2104 | 2188 | 2323 | 2625 | Heavy Duty Construction / Overall Size Increased: W + 1.5", D + 1.5" / Tilt Swivel / Pneumatic Seat Height Adjustment / 350 lb. Wt. Capacity | | |
| | 511-4 | 1332 | 1465 | 1427 | 1511 | 1595 | 1680 | 1764 | 1848 | 1932 | 2016 | 2100 | 2184 | 2317 | 2619 | Knee Tilt Swivel w/ Infinite Lock / Pneumatic Seat Height Adjustment / 350 lb. Weight Capacity | | |
| | HIGH BACK CHAIR / EXPOSED WOOD OPEN ARM / VERTICAL CHANNEL BACK | Overall: 25"w 28"d 45"-48"h Seat: 20.5"w 20"d 17"-20"h | Arm: 25"-28"h Weight: 65 lbs. | COM: 3 yds. COL: 54 sq.ft. | COM | COL | 1 | 2 | 3 | 4 | 5 | 6 | 7 | 8 | 9 | 10 | L1 | L2 |
| | 512-2 | 1312 | 1443 | 1394 | 1471 | 1548 | 1626 | 1703 | 1780 | 1857 | 1934 | 2011 | 2088 | 2206 | 2483 | Tilt Swivel / Pneumatic Seat Height Adjustment / 350 lb. Weight Capacity | | |
| | 512-4 | 1371 | 1508 | 1450 | 1527 | 1605 | 1682 | 1759 | 1836 | 1913 | 1990 | 2067 | 2144 | 2262 | 2539 | Knee Tilt Swivel w/ Infinite Lock / Pneumatic Seat Height Adjustment / 350 lb. Weight Capacity | | |
| | | HIGH BACK CHAIR / FULLY ADJUSTABLE TASK CHAIR / VERTICAL CHANNEL BACK | Overall: 24"w 28"d 45"-48"h Seat: 20.5"w 20"d 17"-20"h | Arm: 25"-28"h Weight: 65 lbs. | COM: 3 yds. COL: 54 sq.ft. | COM | COL | 1 | 2 | 3 | 4 | 5 | 6 | 7 | 8 | 9 | 10 | L1 |
| 513-2 | | 1160 | 1276 | 1251 | 1328 | 1406 | 1483 | 1560 | 1637 | 1714 | 1791 | 1868 | 1945 | 2054 | 2332 | Tilt Swivel / Pneumatic Seat Height Adjustment / 350 lb. Weight Capacity | | |
| 513-4 | | 1220 | 1342 | 1307 | 1385 | 1462 | 1539 | 1616 | 1693 | 1770 | 1847 | 1924 | 2001 | 2110 | 2388 | Knee Tilt Swivel w/ Infinite Lock / Pneumatic Seat Height Adjustment / 350 lb. Weight Capacity | | |

DESCRIPTION:

- Upholstery Frames: Plywood & Hardwood
- Seat / Back: High Density Polyurethane Foam
- Arms: High Density Polyurethane Foam Over Plywood & Hardwood
- Exposed Wood Upholstered Arms & Exposed Wood Open Arms Have Exposed Solid Maple Front Posts Finished In Lacquer
- All Arms Attached & Reinforced w/ Steel
- Black Arched Resin Base Standard
- 10 Year Warranty

OPTIONS:

Specify Exposed Wood Finish (See Page 6)
Base & Caster Options Available (See Conrad Options Pages)

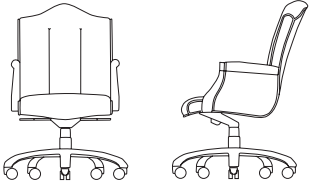
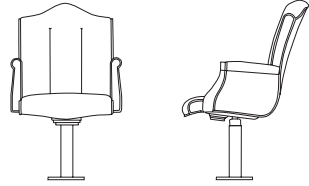
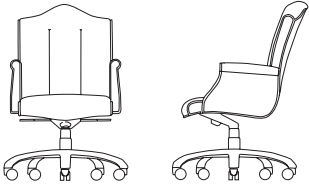
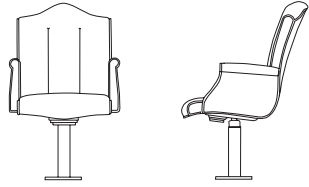
| EXECUTIVE | | ITEM #: | SPECIFICATIONS GRADES LIST PRICES: | | | | | | | | | | | | | | |
|---|--|---|--|------|------|--|------|------|---|------|------|------|------|------|------|------|------|
|  | | LOW BACK CHAIR / EXPOSED WOOD UPHOLSTERED ARM / VERTICAL CHANNEL BACK | Overall: 24.5"w 28"d 36"-39"h Seat: 20.5"w 20"d 17"-20"h | | | Arm: 25"-28"h Weight: 60 lbs. | | | COM: 3 yds. COL: 54 sq.ft. | | | | | | | | |
| | | | COM | COL | 1 | 2 | 3 | 4 | 5 | 6 | 7 | 8 | 9 | 10 | L1 | L2 | |
| | | | 520-2 | 1390 | 1529 | 1468 | 1545 | 1622 | 1699 | 1777 | 1854 | 1931 | 2008 | 2085 | 2162 | 2287 | 2564 |
| | | | <i>Tilt Swivel / Pneumatic Seat Height Adjustment / 350 lb. Weight Capacity</i> | | | | | | | | | | | | | | |
| | | | 520-4 | 1455 | 1600 | 1530 | 1607 | 1684 | 1761 | 1838 | 1915 | 1992 | 2070 | 2147 | 2224 | 2348 | 2626 |
| | | | <i>Knee Tilt Swivel w/ Infinite Lock / Pneumatic Seat Height Adjustment / 350 lb. Weight Capacity</i> | | | | | | | | | | | | | | |
|  | | LOW BACK JURY CHAIR / EXPOSED WOOD UPHOLSTERED ARM / VERTICAL CHANNEL BACK | Overall: 24.5"w 28"d 36"-39"h Seat: 20.5"w 20"d 17"-20"h | | | Arm: 25"-28"h Weight: 60 lbs. | | | COM: 3 yds. COL: 54 sq.ft. | | | | | | | | |
| | | | COM | COL | 1 | 2 | 3 | 4 | 5 | 6 | 7 | 8 | 9 | 10 | L1 | L2 | |
| | | | 520-5 | 1609 | 1770 | 1676 | 1753 | 1830 | 1907 | 1984 | 2061 | 2138 | 2215 | 2293 | 2370 | 2494 | 2772 |
| | | | <i>Tilt Swivel / Pneumatic Seat Height Adjustment / Self-Centering 360° Rotation / 350 lb. Weight Capacity</i> | | | | | | | | | | | | | | |
|  | | LOW BACK CHAIR / FULLY UPHOLSTERED ARM / VERTICAL CHANNEL BACK | Overall: 25"w 28"d 36"-39"h Seat: 20.5"w 20"d 17"-20"h | | | Arm: 25"-28"h Weight: 60 lbs. | | | COM: 3 yds. COL: 54 sq.ft. | | | | | | | | |
| | | | COM | COL | 1 | 2 | 3 | 4 | 5 | 6 | 7 | 8 | 9 | 10 | L1 | L2 | |
| | | | 521-2 | 1248 | 1373 | 1335 | 1412 | 1489 | 1566 | 1643 | 1720 | 1797 | 1874 | 1951 | 2028 | 2155 | 2432 |
| | | | <i>Tilt Swivel / Pneumatic Seat Height Adjustment / 350 lb. Weight Capacity</i> | | | | | | | | | | | | | | |
| | | | 521-4 | 1308 | 1438 | 1391 | 1468 | 1545 | 1622 | 1699 | 1776 | 1853 | 1930 | 2007 | 2085 | 2211 | 2488 |
| | | | <i>Knee Tilt Swivel w/ Infinite Lock / Pneumatic Seat Height Adjustment / 350 lb. Weight Capacity</i> | | | | | | | | | | | | | | |
|  | | LOW BACK JURY CHAIR / FULLY UPHOLSTERED ARM / VERTICAL CHANNEL BACK | Overall: 25"w 28"d 36"-39"h Seat: 20.5"w 20"d 17"-20"h | | | Arm: 25"-28"h Weight: 60 lbs. | | | COM: 3 yds. COL: 54 sq.ft. | | | | | | | | |
| | | | COM | COL | 1 | 2 | 3 | 4 | 5 | 6 | 7 | 8 | 9 | 10 | L1 | L2 | |
| | | | 521-5 | 1468 | 1615 | 1542 | 1619 | 1696 | 1773 | 1850 | 1928 | 2005 | 2082 | 2159 | 2236 | 2362 | 2640 |
| | | | <i>Tilt Swivel / Pneumatic Seat Height Adjustment / Self-Centering 360° Rotation / 350 lb. Weight Capacity</i> | | | | | | | | | | | | | | |

DESCRIPTION:

- Upholstery Frames: Plywood & Hardwood
- Seat / Back: High Density Polyurethane Foam
- Arms: High Density Polyurethane Foam Over Plywood & Hardwood
- Exposed Wood Upholstered Arms & Exposed Wood Open Arms Have Exposed Solid Maple Front Posts Finished In Lacquer
- All Arms Attached & Reinforced w/ Steel
- Task Arm Has Black Urethane Pad & Adjusts Vertically
- Black Arched Resin Base Standard
- 10 Year Warranty

OPTIONS:

Specify Exposed Wood Finish (See Page 6)
Base & Caster Options Available (See Conrad Options Pages)

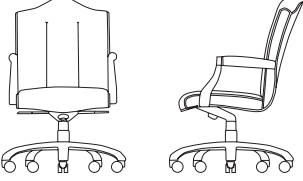
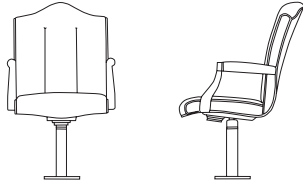
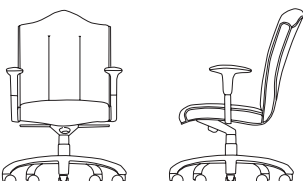
| EXECUTIVE | ITEM #: | SPECIFICATIONS GRADES LIST PRICES: | | | | | | | | | | | | | |
|--|--------------|--|------------|----------|------------------------|----------|----------|-------------------------|----------|----------|----------|----------|-----------|-----------|-----------|
| LOW BACK CHAIR / EXPOSED WOOD OPEN ARM  | | Overall: 24.5"w 28"d 36"-39"h | | | Arm: 25"-28"h | | | COM: 2.75 yds. | | | | | | | |
| | | Seat: 20.5"w 20"d 17"-20"h | | | Weight: 60 lbs. | | | COL: 49.5 sq.ft. | | | | | | | |
| | | COM | COL | 1 | 2 | 3 | 4 | 5 | 6 | 7 | 8 | 9 | 10 | L1 | L2 |
| | 522-2 | 1300 | 1430 | 1369 | 1439 | 1509 | 1579 | 1649 | 1719 | 1790 | 1860 | 1930 | 2000 | 2111 | 2364 |
| | | <i>Tilt Swivel / Pneumatic Seat Height Adjustment / 350 lb. Weight Capacity</i> | | | | | | | | | | | | | |
| | 522-4 | 1359 | 1495 | 1425 | 1495 | 1565 | 1635 | 1705 | 1776 | 1846 | 1916 | 1986 | 2056 | 2168 | 2420 |
| | | <i>Knee Tilt Swivel w/ Infinite Lock / Pneumatic Seat Height Adjustment / 350 lb. Weight Capacity</i> | | | | | | | | | | | | | |
| LOW BACK JURY CHAIR / EXPOSED WOOD OPEN ARM  | | Overall: 24.5"w 28"d 36"-39"h | | | Arm: 25"-28"h | | | COM: 2.75 yds. | | | | | | | |
| | | Seat: 20.5"w 20"d 17"-20"h | | | Weight: 60 lbs. | | | COL: 49.5 sq.ft. | | | | | | | |
| | | COM | COL | 1 | 2 | 3 | 4 | 5 | 6 | 7 | 8 | 9 | 10 | L1 | L2 |
| | 522-5 | 1513 | 1665 | 1543 | 1599 | 1655 | 1711 | 1767 | 1823 | 1879 | 1935 | 1991 | 2048 | 2149 | 2351 |
| | | <i>Tilt Swivel / Pneumatic Seat Height Adjustment / Self-Centering 360° Rotation / 350 lb. Weight Capacity</i> | | | | | | | | | | | | | |
| LOW BACK CHAIR / ADJUSTABLE TASK ARM  | | Overall: 25"w 28"d 36"-39"h | | | Arm: 25"-28"h | | | COM: 2.75 yds. | | | | | | | |
| | | Seat: 20.5"w 20"d 17"-20"h | | | Weight: 60 lbs. | | | COL: 49.5 sq.ft. | | | | | | | |
| | | COM | COL | 1 | 2 | 3 | 4 | 5 | 6 | 7 | 8 | 9 | 10 | L1 | L2 |
| | 523-2 | 1135 | 1249 | 1214 | 1284 | 1354 | 1424 | 1494 | 1564 | 1634 | 1704 | 1774 | 1844 | 1947 | 2199 |
| | | <i>Tilt Swivel / Pneumatic Seat Height Adjustment / 350 lb. Weight Capacity</i> | | | | | | | | | | | | | |
| | 523-4 | 1201 | 1321 | 1275 | 1345 | 1415 | 1486 | 1556 | 1626 | 1696 | 1766 | 1836 | 1906 | 2008 | 2261 |
| | | <i>Knee Tilt Swivel w/ Infinite Lock / Pneumatic Seat Height Adjustment / 350 lb. Weight Capacity</i> | | | | | | | | | | | | | |

DESCRIPTION:

- Upholstery Frames: Plywood & Hardwood
- Seat / Back: High Density Polyurethane Foam
- Arms: High Density Polyurethane Foam Over Plywood & Hardwood
- Exposed Wood Upholstered Arms & Exposed Wood Open Arms Have Exposed Solid Maple Front Posts Finished In Lacquer
- All Arms Attached & Reinforced w/ Steel
- Black Arched Resin Base Standard
- 10 Year Warranty

OPTIONS:

Specify Exposed Wood Finish (See Page 6)
Base & Caster Options Available (See Conrad Options Pages)

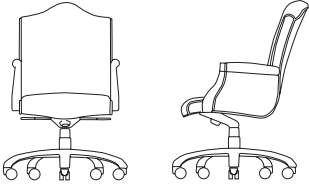
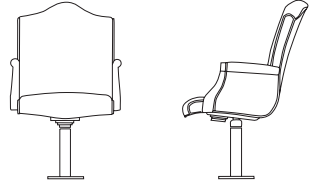
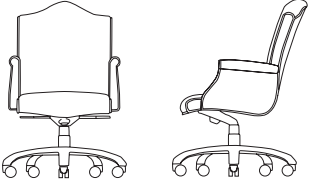
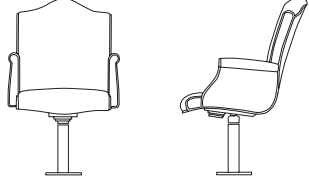
| EXECUTIVE | | ITEM #: | SPECIFICATIONS GRADES LIST PRICES: | | | | | | | | | | | | | | | | | | | | | |
|---|---|--|---|------------|----------|--|----------|----------|--|----------|----------|----------|----------|-----------|-----------|-----------|--|--|--|--|--|--|--|--|
|  | LOW BACK CHAIR / EXPOSED WOOD UPHOLSTERED ARM | | Overall: 24.5"w 28"d 36"-39"h Seat: 20.5"w 20"d 17"-20"h | | | Arm: 25"-28"h Weight: 60 lbs. | | | COM: 3.25 yds. COL: 58.5 sq.ft. | | | | | | | | | | | | | | | |
| | | | COM | COL | 1 | 2 | 3 | 4 | 5 | 6 | 7 | 8 | 9 | 10 | L1 | L2 | | | | | | | | |
| | 530-2 | | 1333 | 1466 | 1428 | 1513 | 1597 | 1681 | 1765 | 1849 | 1933 | 2017 | 2101 | 2185 | 2309 | 2611 | | | | | | | | |
| | | <i>Tilt Swivel / Pneumatic Seat Height Adjustment / 350 lb. Weight Capacity</i> | | | | | | | | | | | | | | | | | | | | | | |
| | | 530-4 | 1392 | 1531 | 1484 | 1569 | 1653 | 1737 | 1821 | 1905 | 1989 | 2073 | 2157 | 2242 | 2365 | 2668 | | | | | | | | |
| | | <i>Knee Tilt Swivel w/ Infinite Lock / Pneumatic Seat Height Adjustment / 350 lb. Weight Capacity</i> | | | | | | | | | | | | | | | | | | | | | | |
|  | LOW BACK JURY CHAIR / EXPOSED WOOD UPHOLSTERED ARM | | Overall: 24.5"w 28"d 36"-39"h Seat: 20.5"w 20"d 17"-20"h | | | Arm: 25"-28"h Weight: 60 lbs. | | | COM: 3.25 yds. COL: 58.5 sq.ft. | | | | | | | | | | | | | | | |
| | | | COM | COL | 1 | 2 | 3 | 4 | 5 | 6 | 7 | 8 | 9 | 10 | L1 | L2 | | | | | | | | |
| | 530-5 | | 1546 | 1701 | 1630 | 1714 | 1799 | 1883 | 1967 | 2051 | 2135 | 2219 | 2303 | 2387 | 2511 | 2813 | | | | | | | | |
| | | <i>Tilt Swivel / Pneumatic Seat Height Adjustment / Self-Centering 360° Rotation / 350 lb. Weight Capacity</i> | | | | | | | | | | | | | | | | | | | | | | |
|  | LOW BACK CHAIR / FULLY UPHOLSTERED ARM | | Overall: 26"w 28"d 36"-39"h Seat: 20.5"w 20"d 17"-20"h | | | Arm: 25"-28"h Weight: 60 lbs. | | | COM: 3.25 yds. COL: 58.5 sq.ft. | | | | | | | | | | | | | | | |
| | | | COM | COL | 1 | 2 | 3 | 4 | 5 | 6 | 7 | 8 | 9 | 10 | L1 | L2 | | | | | | | | |
| | 531-2 | | 1213 | 1334 | 1315 | 1399 | 1483 | 1567 | 1651 | 1735 | 1820 | 1904 | 1988 | 2072 | 2199 | 2501 | | | | | | | | |
| | | <i>Tilt Swivel / Pneumatic Seat Height Adjustment / 350 lb. Weight Capacity</i> | | | | | | | | | | | | | | | | | | | | | | |
| | | 531-4 | 1272 | 1399 | 1371 | 1455 | 1539 | 1623 | 1707 | 1792 | 1876 | 1960 | 2044 | 2128 | 2255 | 2558 | | | | | | | | |
| | | <i>Knee Tilt Swivel w/ Infinite Lock / Pneumatic Seat Height Adjustment / 350 lb. Weight Capacity</i> | | | | | | | | | | | | | | | | | | | | | | |
|  | LOW BACK JURY CHAIR / FULLY UPHOLSTERED ARM | | Overall: 26"w 28"d 36"-39"h Seat: 20.5"w 20"d 17"-20"h | | | Arm: 25"-28"h Weight: 60 lbs. | | | COM: 3.25 yds. COL: 58.5 sq.ft. | | | | | | | | | | | | | | | |
| | | | COM | COL | 1 | 2 | 3 | 4 | 5 | 6 | 7 | 8 | 9 | 10 | L1 | L2 | | | | | | | | |
| | 531-5 | | 1426 | 1569 | 1517 | 1601 | 1685 | 1769 | 1853 | 1937 | 2021 | 2106 | 2190 | 2274 | 2401 | 2703 | | | | | | | | |
| | | <i>Tilt Swivel / Pneumatic Seat Height Adjustment / Self-Centering 360° Rotation / 350 lb. Weight Capacity</i> | | | | | | | | | | | | | | | | | | | | | | |

DESCRIPTION:

- Upholstery Frames: Plywood & Hardwood
- Seat / Back: High Density Polyurethane Foam
- Arms: High Density Polyurethane Foam Over Plywood & Hardwood
- Exposed Wood Upholstered Arms & Exposed Wood Open Arms Have Exposed Solid Maple Front Posts Finished In Lacquer
- All Arms Attached & Reinforced w/ Steel
- Task Arm Has Black Urethane Pad & Adjusts Vertically
- Black Arched Resin Base Standard
- 10 Year Warranty

OPTIONS:

Specify Exposed Wood Finish (See Page 6)
Base & Caster Options Available (See Conrad Options Pages)

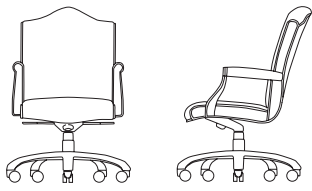
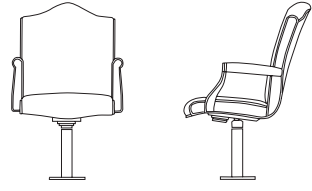
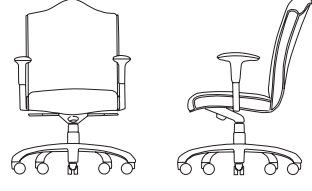
| EXECUTIVE | ITEM #: | SPECIFICATIONS GRADES LIST PRICES: | | | | | | | | | | | | | |
|---|--|--|------------|----------|--|----------|----------|--|----------|----------|----------|----------|-----------|-----------|-----------|
|  | LOW BACK CHAIR / EXPOSED WOOD OPEN ARM | Overall: 25"w 28"d 36"-39"h Seat: 20.5"w 20"d 17"-20"h | | | Arm: 25"-28"h Weight: 60 lbs. | | | COM: 2.75 yds. COL: 49.5 sq.ft. | | | | | | | |
| | | COM | COL | 1 | 2 | 3 | 4 | 5 | 6 | 7 | 8 | 9 | 10 | L1 | L2 |
| | 532-2 | 1255 | 1380 | 1327 | 1397 | 1467 | 1537 | 1607 | 1677 | 1747 | 1817 | 1888 | 1958 | 2064 | 2316 |
| | | <i>Tilt Swivel / Pneumatic Seat Height Adjustment / 350 lb. Weight Capacity</i> | | | | | | | | | | | | | |
| | 532-4 | 1314 | 1446 | 1383 | 1453 | 1523 | 1593 | 1663 | 1733 | 1803 | 1873 | 1944 | 2014 | 2120 | 2373 |
| | | <i>Knee Tilt Swivel w/ Infinite Lock / Pneumatic Seat Height Adjustment / 350 lb. Weight Capacity</i> | | | | | | | | | | | | | |
|  | LOW BACK JURY CHAIR / EXPOSED WOOD OPEN ARM | Overall: 25"w 28"d 36"-39"h Seat: 20.5"w 20"d 17"-20"h | | | Arm: 25"-28"h Weight: 60 lbs. | | | COM: 2.75 yds. COL: 49.5 sq.ft. | | | | | | | |
| | | COM | COL | 1 | 2 | 3 | 4 | 5 | 6 | 7 | 8 | 9 | 10 | L1 | L2 |
| | 532-5 | 1469 | 1615 | 1529 | 1599 | 1669 | 1739 | 1809 | 1879 | 1949 | 2019 | 2089 | 2159 | 2266 | 2518 |
| | | <i>Tilt Swivel / Pneumatic Seat Height Adjustment / Self-Centering 360° Rotation / 350 lb. Weight Capacity</i> | | | | | | | | | | | | | |
|  | LOW BACK CHAIR / ADJUSTABLE TASK CHAIR | Overall: 24"w 28"d 36"-39"h Seat: 20.5"w 20"d 17"-20"h | | | Arm: 25"-28"h Weight: 60 lbs. | | | COM: 2.75 yds. COL: 49.5 sq.ft. | | | | | | | |
| | | COM | COL | 1 | 2 | 3 | 4 | 5 | 6 | 7 | 8 | 9 | 10 | L1 | L2 |
| | 533-2 | 1096 | 1205 | 1176 | 1246 | 1316 | 1386 | 1456 | 1526 | 1597 | 1667 | 1737 | 1807 | 1905 | 2157 |
| | | <i>Tilt Swivel / Pneumatic Seat Height Adjustment / 350 lb. Weight Capacity</i> | | | | | | | | | | | | | |
| | 533-4 | 1155 | 1270 | 1232 | 1302 | 1372 | 1442 | 1512 | 1583 | 1653 | 1723 | 1793 | 1863 | 1961 | 2213 |
| | | <i>Knee Tilt Swivel w/ Infinite Lock / Pneumatic Seat Height Adjustment / 350 lb. Weight Capacity</i> | | | | | | | | | | | | | |

DESCRIPTION:



- Exposed Frames: Solid Maple
- Seat: High Density Polyurethane Foam Over Sheet Webbing
- Back: High Density Polyurethane Foam Over Polypropylene Webbing
- Upholstered Arms: Polyurethane Foam Over Hardwood
- Stacking Chairs Stack (4) High
- 10 Year Warranty

OPTIONS:

- D350-6 Single Stacking Cart (Stacks 6 Chairs).....\$960
- D350-12 Double Stacing Cart (Stacks 12 Chairs).....\$1268
- ST-1 Wooden Horizontal Stretchers.....\$97
- BR-1 Wooden Horizontal Book Rack.....\$218

Specify Exposed Wood Finish (See Page 6)

Upholstered Arms May Be Specified In Vinyl / Leather (Contact Factory For Details)

| GUEST | ITEM #: | SPECIFICATIONS GRADES LIST PRICES: | | | | | | | | | | | | | |
|--|---------|--|------------|------------------------|----------|-------------------------|----------|----------|----------|----------|----------|----------|-----------|-----------|-----------|
| <p>STACKING ARM CHAIR / UPHOLSTERED ARM</p>  | 550 | Overall: 23"w 25"d 35"h | | Arm: 25"h | | COM: 1.75 yds. | | | | | | | | | |
| | | Seat: 19.25"w 18"d 19"h | | Weight: 25 lbs. | | COL: 31.5 sq.ft. | | | | | | | | | |
| | | COM | COL | 1 | 2 | 3 | 4 | 5 | 6 | 7 | 8 | 9 | 10 | L1 | L2 |
| | | 1081 | 1190 | 1107 | 1149 | 1191 | 1233 | 1275 | 1317 | 1359 | 1401 | 1443 | 1485 | 1554 | 1705 |
| <i>Open Back / 350 lb. Weight Capacity</i> | | | | | | | | | | | | | | | |
| <p>CLOSED ARM SIDE CHAIR</p>  | 560 | Overall: 23"w 25"d 35"h | | Arm: 25"h | | COM: 2.5 yds. | | | | | | | | | |
| | | Seat: 19.25"w 18"d 19"h | | Weight: 40 lbs. | | COL: 45 sq.ft. | | | | | | | | | |
| | | COM | COL | 1 | 2 | 3 | 4 | 5 | 6 | 7 | 8 | 9 | 10 | L1 | L2 |
| | | 1265 | 1392 | 1322 | 1385 | 1448 | 1512 | 1575 | 1638 | 1701 | 1764 | 1827 | 1890 | 1987 | 2214 |
| <i>Closed Back / 350 lb. Weight Capacity</i> | | | | | | | | | | | | | | | |
| <p>OPEN ARM SIDE CHAIR / UPHOLSTERED TOP ARM / TUFTED BACK</p>  | 571 | Overall: 23"w 25"d 35"h | | Arm: 25"h | | COM: 2 yds. | | | | | | | | | |
| | | Seat: 19.25"w 18"d 19"h | | Weight: 35 lbs. | | COL: 36 sq.ft. | | | | | | | | | |
| | | COM | COL | 1 | 2 | 3 | 4 | 5 | 6 | 7 | 8 | 9 | 10 | L1 | L2 |
| | | 1092 | 1201 | 1131 | 1180 | 1229 | 1278 | 1327 | 1376 | 1425 | 1474 | 1523 | 1572 | 1656 | 1832 |
| <i>Closed Tufted Back / 350 lb. Weight Capacity</i> | | | | | | | | | | | | | | | |

DESCRIPTION:

- Exposed Frames: Solid Maple
- Seat: High Density Polyurethane Foam Over Sheet Webbing
- Back: High Density Polyurethane Foam Over Polypropylene Webbing
- Upholstered Arms: Polyurethane Foam Over Hardwood
- 10 Year Warranty



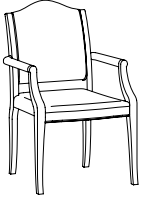

OPTIONS:

- ST-1 Wooden Horizontal Stretchers.....\$97
- BR-1 Wooden Horizontal Book Rack.....\$218

Specify Exposed Wood Finish (See Page 6)
 Upholstered Arms May Be Specified In Vinyl / Leather (Contact Factory For Details)

| GUEST | ITEM #: | SPECIFICATIONS GRADES LIST PRICES: | | | | | | | | | | | | | |
|--|---------|---|------|---|------|---|------|------|------|------|------|------|------|------|------|
| <p>OPEN ARM SIDE CHAIR / UPHOLSTERED TOP ARM</p>  | 572 | <p>Overall: 23"w 25"d 35"h Seat: 19.25"w 18"d 19"h</p> | | <p>Arm: 25"h Weight: 35 lbs.</p> | | <p>COM: 1.75 yds. COL: 31.5 sq.ft.</p> | | | | | | | | | |
| | | COM | COL | 1 | 2 | 3 | 4 | 5 | 6 | 7 | 8 | 9 | 10 | L1 | L2 |
| | | 1028 | 1131 | 1056 | 1098 | 1140 | 1182 | 1225 | 1267 | 1309 | 1351 | 1393 | 1435 | 1495 | 1646 |
| | | <p><i>Open Back / 350 lb. Weight Capacity</i></p> | | | | | | | | | | | | | |
| <p>OPEN ARM SIDE CHAIR / EXPOSED WOOD TOP ARM</p>  | 577 | <p>Overall: 23"w 25"d 35"h Seat: 19.25"w 18"d 19"h</p> | | <p>Arm: 25"h Weight: 35 lbs.</p> | | <p>COM: 1.75 yds. COL: 31.5 sq.ft.</p> | | | | | | | | | |
| | | COM | COL | 1 | 2 | 3 | 4 | 5 | 6 | 7 | 8 | 9 | 10 | L1 | L2 |
| | | 1101 | 1212 | 1125 | 1167 | 1210 | 1252 | 1294 | 1336 | 1378 | 1420 | 1462 | 1504 | 1567 | 1719 |
| | | <p><i>Open Back / 350 lb. Weight Capacity</i></p> | | | | | | | | | | | | | |

| BASES | OPTION #: | SPECIFICATIONS LIST PRICES AVAILABILITY: |
|--|-----------|---|
| <p data-bbox="94 176 326 205">TRANSITIONAL WOOD BASE</p>  | TWB | <p data-bbox="581 176 781 205">Overall: 25"w 25"d 5.5"h</p> <hr/> <p data-bbox="581 268 630 298">\$237</p> <p data-bbox="581 298 1208 327"><i>Solid Hardwood Cap, Steel Reinforced 5 Prong Base With 55mm Black Dual Wheel Casters.</i></p> <p data-bbox="581 344 1179 415"> OPTIONS: C1 Carpet Caster - 2" Metal Balls \$164 (Set Of 5) C2 Antique Bronze Hooded Caster - 2" Rubber Ball \$151 (Set Of 5) C3 Brass Hooded Black Caster - 2" Dual Wheels \$84 (Set Of 5) </p> <p data-bbox="581 466 854 495">Available: <i>Conrad Executive Seating</i></p> |
| <p data-bbox="94 638 277 667">CLASSIC WOOD BASE</p>  | CWB | <p data-bbox="581 638 764 667">Overall: 28"w 28"d 5"h</p> <hr/> <p data-bbox="581 730 630 760">\$237</p> <p data-bbox="581 760 1208 789"><i>Solid Hardwood Cap, Steel Reinforced 5 Prong Base With 55mm Black Dual Wheel Casters.</i></p> <p data-bbox="581 806 1179 903"> OPTIONS: C1 Carpet Caster - 2" Metal Balls \$164 (Set Of 5) C2 Antique Bronze Hooded Caster - 2" Rubber Ball \$151 (Set Of 5) C3 Brass Hooded Black Caster - 2" Dual Wheels \$84 (Set Of 5) SP Brass Scuff Plates \$121 (Set Of 5) </p> <p data-bbox="581 953 854 982">Available: <i>Conrad Executive Seating</i></p> |
| <p data-bbox="94 1100 272 1129">ARCHED RESIN BASE</p>  | ARB | <p data-bbox="581 1100 789 1129">Overall: 27"w 27"d 6.25"h</p> <hr/> <p data-bbox="581 1192 769 1222">Standard - No Charge</p> <p data-bbox="581 1222 1105 1251"><i>Black Reinforced Nylon 5 Prong Base With 55mm Black Dual Wheel Casters.</i></p> <p data-bbox="581 1268 1235 1297"> OPTIONS: C4 Black Sculptured Glides No Upcharge (Set Of 5) </p> <p data-bbox="581 1348 854 1377">Available: <i>Conrad Executive Seating</i></p> |
| <p data-bbox="94 1562 326 1591">POLISHED ALUMINUM BASE</p>  | PAB | <p data-bbox="581 1562 764 1591">Overall: 26"w 26"d 8"h</p> <hr/> <p data-bbox="581 1654 630 1684">\$120</p> <p data-bbox="581 1684 1073 1713"><i>Polished Aluminum 5 Prong Base With 55mm Black Dual Wheel Casters</i></p> <p data-bbox="581 1730 1235 1785"> OPTIONS: C4 Black Sculptured Glides No Upcharge (Set Of 5) C5 Polished Aluminum Hooded Casters \$105 (Set Of 5) </p> <p data-bbox="581 1810 854 1839">Available: <i>Conrad Executive Seating</i></p> |

| BASES / CASTERS / SCUFF PLATES | OPTION #: | SPECIFICATIONS LIST PRICES AVAILABILITY: |
|--|--|--|
| <p>HIGH PROFILE BASE</p>  | <p>HPB</p> <p>No Charge <i>Black Reinforced Nylon 5 Prong Base With 55mm Black Dual Wheel Casters</i></p> <p>Available: Conrad Executive Seating</p> | |
| <p>JURY BASE</p>  | <p>JRB</p> <p>Overall: 8.5" Diameter 3.75"h</p> <p>\$200 <i>360° Rotation, Self Centering With Pneumatic Height Adjustment</i></p> <p>OPTIONS: No Rotation</p> <p>Available: Conrad Executive Seating</p> | |
| <p>CASTERS</p>  <p>(C1) Carpet Caster - 2" Metal Balls</p> <p>(C2) Antique Bronze Hooded Caster - 2" Rubber Ball</p> <p>(C3) Brass Hooded Black Caster - 2" Dual Wheels</p> <p>(C4) Black Sculptured Glide - 2" Flat Bottom Glide</p> <p>(C5) Polished Aluminum Caster - 2" Dual Wheels</p> | <p>Overall: 2"h</p> <p>C1 \$200 (Set Of 5) <i>Carpet Caster - 2" Metal Balls - Antique Windsor (Additional Finishes Available)</i></p> <p>C2 \$152 (Set Of 5) <i>Antique Bronze Hooded Caster - 2" Rubber Ball (Additional Finishes Available)</i></p> <p>C3 \$95 (Set Of 5) <i>Brass Hooded Black Caster - 2" Dual Wheels (Additional Finishes Available)</i></p> <p>C4 No Charge (Set Of 5) <i>Black Sculptured Glide - 2" Flat Bottom Glide</i></p> <p>C5 \$105 (Set Of 5) <i>Polished Aluminum Hooded Caster - 2" Dual Wheels</i></p> <p>Available: Conrad Executive Seating</p> | |
| <p>SCUFF PLATES</p>  | <p>SP</p> <p>Overall: 1"w 4"d</p> <p>\$121 (Set Of 5) <i>(Specify Brass Or Pewter)</i></p> <p>Available: Classic Base Only</p> | |

| STRETCHERS / BOOK RACK / STACKING / COVERS | OPTION #: | SPECIFICATIONS LIST PRICES AVAILABILITY: |
|--|--|--|
| <p>STRETCHERS</p>  | <p>ST-1</p> <p><i>Overall: 23"w 25"d 1"h</i></p> <p>\$97 <i>Wooden Horizontal Stretchers</i></p> <p><i>Available: Conrad Guest Chairs</i></p> | |
| <p>BOOK RACK</p>  | <p>BR-1</p> <p><i>Overall: 23"w 25"d 1"h</i></p> <p>\$218 <i>Wooden Horizontal Book Rack</i></p> <p><i>Available: Conrad Guest Chairs</i></p> | |
| <p>STACKING CARTS</p>  <p>Single Stacking</p> <p>Double Stacking</p> | <p><i>Overall: 26"w 37"d 12"h (Single Stacking Cart) / 37"w 50"d 12"h (Double Stacking Cart)</i></p> <p>D350-6</p> <p>\$960 <i>Single Stacking Cart (Stacks 6 Chairs)</i></p> <p>D350-12</p> <p>\$1268 <i>Double Stacking Cart (Stacks 12 Chairs)</i></p> <p><i>Available: Conrad Stacking Chairs</i></p> | |
| <p>CONTRASTING COVERS</p>  | <p><i>Overall: n/a</i></p> <p>CC</p> <p>\$129</p> <p><i>NOTE: If Two Or More Upholsteries Or Leathers Are Used On Any Piece Of Furniture, Then A Contrast Charge Will Apply Per Order. When Using Trinity Upholstery, The Higher Priced Upholstery Grade Will Be Used In Pricing, Unless It's Trinity Leather With Fabric Contrast Welt, Or COM With Trinity Contrast Welt, Then Contact Customer Service For Pricing.</i></p> <p><i>Available: Conrad Collection</i></p> | |

Classic

EXECUTIVE / GUEST / LOUNGE / BENCHES / TABLES

Effective: March 1, 2025

T R I N I T Y

Date:

Page:

Modification:

Description:

DESCRIPTION:

- Upholstery Frames: Hardwood & Plywood
- Seat: High Density Polyurethane Foam Over Sheet Webbing
- Back: High Density Polyurethane Foam Over Polypropylene Webbing
- Upholstered Arms: Exposed Solid Cherry Front Posts w/ Rosette Medallions In Lacquer Finish
- Classic Base Standard
- 10 Year Warranty

OPTIONS:

- IL Inflatable Lumbar (#700, 701, 710, & 711 Models).....\$285
- CCM Concentric Arm Medallion (Please Specify)..... N/C

Specify Exposed Wood Finish (See Page 6)
Base & Caster Options Available (See Classic Options Pages)

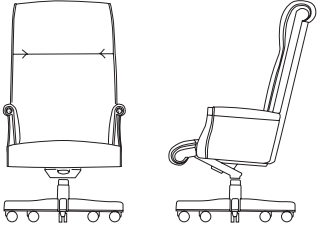
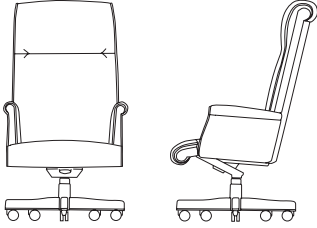
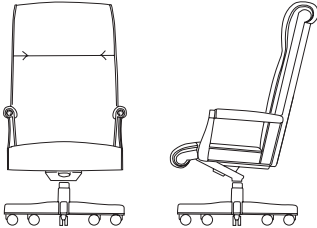
| EXECUTIVE | ITEM #: | SPECIFICATIONS GRADES LIST PRICES: | | | | | | | | | | | | | |
|---|---------------|--|------------|------------------------|----------|--|----------|----------|----------|----------|----------|----------|-----------|-----------|-----------|
| <p>HIGH BACK JUDGES CHAIR / EXPOSED WOOD UPHOLSTERED ARM</p>  | | Overall: 27.5"w 31.5"d 50"-53"h | | Arm: 26"-29"h | | COM: 5.25 yds. (700-3 / 700-4) / 5.5 yds. (700-4X) | | | | | | | | | |
| | | Seat: 21"w 19"d 18.5"-21.5"h | | Weight: 85 lbs. | | COL: 94.5 sq.ft. (700-3 / 700-4) / 99 sq.ft. (700-4X) | | | | | | | | | |
| | | COM | COL | 1 | 2 | 3 | 4 | 5 | 6 | 7 | 8 | 9 | 10 | L1 | L2 |
| | 700-3 | 2129 | 2342 | 2293 | 2433 | 2573 | 2714 | 2854 | 2994 | 3134 | 3274 | 3415 | 3555 | 3747 | 4252 |
| | | <i>Tilt Swivel Infinite Lock / Pneumatic Seat Height Adjustment / 350 lb. Weight Capacity</i> | | | | | | | | | | | | | |
| | 700-4 | 2152 | 2368 | 2315 | 2456 | 2596 | 2736 | 2876 | 3016 | 3157 | 3297 | 3437 | 3577 | 3769 | 4274 |
| | | <i>Knee Tilt Swivel w/ Infinite Lock / Pneumatic Seat Height Adjustment / 350 lb. Weight Capacity</i> | | | | | | | | | | | | | |
| | 700-4X | 2170 | 2387 | 2346 | 2493 | 2641 | 2788 | 2935 | 3082 | 3229 | 3377 | 3524 | 3671 | 3868 | 4398 |
| | | <i>Big & Tall: Knee Tilt Swivel w/ Infinite Lock / Pneumatic Seat Height Adjustment / Overall Size Increased: W + 1.5" / 400 lb. Weight Capacity</i> | | | | | | | | | | | | | |
| <p>HIGH BACK JUDGES CHAIR / FULLY UPHOLSTERED ARM</p>  | | Overall: 27.5"w 31.5"d 50"-53"h | | Arm: 26"-29"h | | COM: 5.25 yds. (701-3 / 701-4) / 5.5 yds. (701-4X) | | | | | | | | | |
| | | Seat: 21"w 19"d 18.5"-21.5"h | | Weight: 85 lbs. | | COL: 94.5 sq.ft. (701-3 / 701-4) / 99 sq.ft. (701-4X) | | | | | | | | | |
| | | COM | COL | 1 | 2 | 3 | 4 | 5 | 6 | 7 | 8 | 9 | 10 | L1 | L2 |
| | 701-3 | 1927 | 2120 | 2102 | 2242 | 2383 | 2523 | 2663 | 2803 | 2943 | 3084 | 3224 | 3364 | 3559 | 4064 |
| | | <i>Tilt Swivel Infinite Lock / Pneumatic Seat Height Adjustment / 350 lb. Weight Capacity</i> | | | | | | | | | | | | | |
| | 701-4 | 1957 | 2152 | 2130 | 2271 | 2411 | 2551 | 2691 | 2831 | 2972 | 3112 | 3252 | 3392 | 3587 | 4092 |
| | | <i>Knee Tilt Swivel w/ Infinite Lock / Pneumatic Seat Height Adjustment / 350 lb. Weight Capacity</i> | | | | | | | | | | | | | |
| | 701-4X | 2022 | 2224 | 2206 | 2353 | 2500 | 2648 | 2795 | 2942 | 3089 | 3236 | 3384 | 3531 | 3721 | 4249 |
| | | <i>Big & Tall: Knee Tilt Swivel w/ Infinite Lock / Pneumatic Seat Height Adjustment / Overall Size Increased: W + 1.5" / 400 lb. Weight Capacity</i> | | | | | | | | | | | | | |
| <p>HIGH BACK CHAIR / OPEN WOOD UPHOLSTERED ARM</p>  | | Overall: 27.5"w 31.5"d 50"-53"h | | Arm: 26"-29"h | | COM: 5.25 yds. (700-3 / 700-4) | | | | | | | | | |
| | | Seat: 21"w 19"d 18.5"-21.5"h | | Weight: 85 lbs. | | COL: 94.5 sq.ft. (700-3 / 700-4) | | | | | | | | | |
| | | COM | COL | 1 | 2 | 3 | 4 | 5 | 6 | 7 | 8 | 9 | 10 | L1 | L2 |
| | 702-3 | 2081 | 2289 | 2248 | 2388 | 2528 | 2669 | 2809 | 2949 | 3089 | 3229 | 3370 | 3510 | 3705 | 4209 |
| | | <i>Tilt Swivel w/ Lock / Pneumatic Seat Height Adjustment / 350 lb. Weight Capacity</i> | | | | | | | | | | | | | |
| | 702-4 | 2111 | 2322 | 2276 | 2416 | 2557 | 2697 | 2837 | 2977 | 3117 | 3258 | 3398 | 3538 | 3733 | 4237 |
| | | <i>Knee Tilt Swivel w/ Infinite Lock / Pneumatic Seat Height Adjustment / 350 lb. Weight Capacity</i> | | | | | | | | | | | | | |

DESCRIPTION:

- Upholstery Frames: Hardwood & Plywood
- Seat: High Density Polyurethane Foam Over Sheet Webbing
- Back: High Density Polyurethane Foam Over Polypropylene Webbing
- Upholstered Arms: Exposed Solid Cherry Front Posts w/ Rosette Medallions In Lacquer Finish
- Classic Base Standard
- 10 Year Warranty

OPTIONS:

- IL Inflatable Lumbar (#700, 701, 710, & 711 Models).....\$285
- CCM Concentric Arm Medallion (Please Specify)..... N/C

Specify Exposed Wood Finish (See Page 6)
Base & Caster Options Available (See Classic Options Pages)

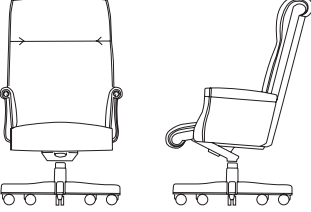
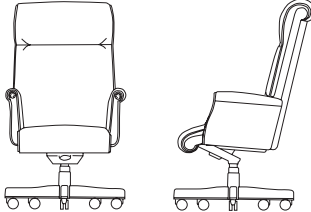
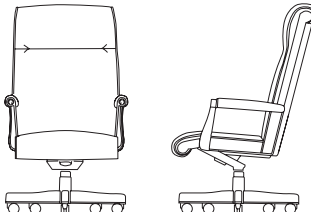





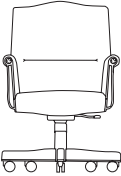

| EXECUTIVE | | ITEM #: | SPECIFICATIONS GRADES LIST PRICES: | | | | | | | | | | | | | | |
|---|--|---|---|------------|----------|--|----------|----------|--|----------|----------|----------|----------|-----------|-----------|-----------|------|
|  | | MEDIUM BACK CHAIR / EXPOSED WOOD UPHOLSTERED ARM | Overall: 27.5"w 31.5"d 46"-49"h Seat: 21"w 19"d 18.5"-21.5"h | | | Arm: 26"-29"h Weight: 70 lbs. | | | COM: 5.25 yds. COL: 94.5 sq.ft. | | | | | | | | |
| | | | COM | COL | 1 | 2 | 3 | 4 | 5 | 6 | 7 | 8 | 9 | 10 | L1 | L2 | |
| | | | 710-2 | 2059 | 2265 | 2228 | 2368 | 2508 | 2648 | 2788 | 2928 | 3069 | 3209 | 3349 | 3489 | 3681 | 4185 |
| | | | <i>Tilt Swivel w/ Lock / Pneumatic Seat Height Adjustment / 350 lb. Weight Capacity</i> | | | | | | | | | | | | | | |
| | | 710-3 | 2077 | 2285 | 2244 | 2385 | 2525 | 2665 | 2805 | 2945 | 3086 | 3226 | 3366 | 3506 | 3697 | 4202 | |
| <i>Tilt Swivel Infinite Lock / Pneumatic Seat Height Adjustment / 350 lb. Weight Capacity</i> | | | | | | | | | | | | | | | | | |
| | | 710-4 | 2101 | 2311 | 2267 | 2407 | 2547 | 2687 | 2828 | 2968 | 3108 | 3248 | 3388 | 3529 | 3720 | 4225 | |
| <i>Knee Tilt Swivel w/ Infinite Lock / Pneumatic Seat Height Adjustment / 350 lb. Weight Capacity</i> | | | | | | | | | | | | | | | | | |
|  | | MEDIUM BACK CHAIR / FULLY UPHOLSTERED ARM | Overall: 27.5"w 31.5"d 46"-49"h Seat: 21"w 19"d 18.5"-21.5"h | | | Arm: 26"-29"h Weight: 70 lbs. | | | COM: 5.25 yds. COL: 94.5 sq.ft. | | | | | | | | |
| | | | COM | COL | 1 | 2 | 3 | 4 | 5 | 6 | 7 | 8 | 9 | 10 | L1 | L2 | |
| | | | 711-2 | 1857 | 2043 | 2037 | 2177 | 2317 | 2457 | 2597 | 2737 | 2878 | 3018 | 3158 | 3298 | 3492 | 3997 |
| | | | <i>Tilt Swivel w/ Lock / Pneumatic Seat Height Adjustment / 350 lb. Weight Capacity</i> | | | | | | | | | | | | | | |
| | | 711-3 | 1881 | 2069 | 2059 | 2199 | 2339 | 2480 | 2620 | 2760 | 2900 | 3040 | 3181 | 3321 | 3515 | 4019 | |
| <i>Tilt Swivel Infinite Lock / Pneumatic Seat Height Adjustment / 350 lb. Weight Capacity</i> | | | | | | | | | | | | | | | | | |
| | | 711-4 | 1917 | 2108 | 2093 | 2233 | 2373 | 2513 | 2653 | 2794 | 2934 | 3074 | 3214 | 3354 | 3548 | 4053 | |
| <i>Knee Tilt Swivel w/ Infinite Lock / Pneumatic Seat Height Adjustment / 350 lb. Weight Capacity</i> | | | | | | | | | | | | | | | | | |
|  | | MEDIUM BACK CHAIR / OPEN WOOD UPHOLSTERED ARM | Overall: 27.5"w 31.5"d 46"-49"h Seat: 21"w 19"d 18.5"-21.5"h | | | Arm: 26"-29"h Weight: 70 lbs. | | | COM: 5.25 yds. COL: 94.5 sq.ft. | | | | | | | | |
| | | | COM | COL | 1 | 2 | 3 | 4 | 5 | 6 | 7 | 8 | 9 | 10 | L1 | L2 | |
| | | | 712-3 | 2022 | 2224 | 2192 | 2332 | 2472 | 2613 | 2753 | 2893 | 3033 | 3173 | 3314 | 3454 | 3649 | 4153 |
| | | | <i>Tilt Swivel Infinite Lock / Pneumatic Seat Height Adjustment / 350 lb. Weight Capacity</i> | | | | | | | | | | | | | | |
| | | 712-4 | 2052 | 2257 | 2220 | 2360 | 2500 | 2641 | 2781 | 2921 | 3061 | 3201 | 3342 | 3482 | 3677 | 4181 | |
| <i>Knee Tilt Swivel w/ Infinite Lock / Pneumatic Seat Height Adjustment / 350 lb. Weight Capacity</i> | | | | | | | | | | | | | | | | | |

DESCRIPTION:

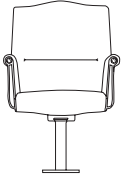
- Upholstery Frames: Hardwood & Plywood
- Seat: High Density Polyurethane Foam Over Sheet Webbing
- Back: High Density Polyurethane Foam Over Polypropylene Webbing
- Upholstered Arms: Exposed Solid Cherry Front Posts w/ Rosette Medallions In Lacquer Finish
- Classic Base Standard
- 10 Year Warranty

OPTIONS:

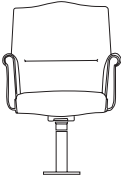
CCM Concentric Arm Medallion (Please Specify)..... N/C
 Specify Exposed Wood Finish (See Page 6)
 Base & Caster Options Available (See Classic Options Pages)









| EXECUTIVE | | ITEM #: | SPECIFICATIONS GRADES LIST PRICES: | | | | | | | | | | | | | | | | | | |
|---|---|--|---|---|--|--|--|---|----------|----------|----------|----------|----------|-----------|-----------|-----------|--|--|--|--|--|
|   | LOW BACK CHAIR / EXPOSED WOOD UPHOLSTERED ARM | | Overall: 25.5"w 29"d 36"-39"h Seat: 21"w 19"d 18.5"-21.5"h | | Arm: 26"-29"h Weight: 60 lbs. | | COM: 3.25 yds. COL: 58.5 sq.ft. | | | | | | | | | | | | | | |
| | | 720-2 | COM | COL | 1 | 2 | 3 | 4 | 5 | 6 | 7 | 8 | 9 | 10 | L1 | L2 | | | | | |
| | | 720-4 | COM | COL | 1 | 2 | 3 | 4 | 5 | 6 | 7 | 8 | 9 | 10 | L1 | L2 | | | | | |
|   | LOW BACK JURY CHAIR / EXPOSED WOOD UPHOLSTERED ARM | | Overall: 25.5"w 29"d 36"-39"h Seat: 21"w 19"d 18.5"-21.5"h | | Arm: 26"-29"h Weight: 60 lbs. | | COM: 3.25 yds. COL: 58.5 sq.ft. | | | | | | | | | | | | | | |
| | | 720-5 | COM | COL | 1 | 2 | 3 | 4 | 5 | 6 | 7 | 8 | 9 | 10 | L1 | L2 | | | | | |
| |   | LOW BACK CHAIR / FULLY UPHOLSTERED ARM | | Overall: 25.5"w 29"d 36"-39"h Seat: 21"w 19"d 18.5"-21.5"h | | Arm: 26"-29"h Weight: 60 lbs. | | COM: 3.5 yds. COL: 63 sq.ft. | | | | | | | | | | | | | |
| | | 721-2 | COM | COL | 1 | 2 | 3 | 4 | 5 | 6 | 7 | 8 | 9 | 10 | L1 | L2 | | | | | |
|   | | LOW BACK JURY CHAIR / FULLY UPHOLSTERED ARM | | Overall: 25.5"w 29"d 36"-39"h Seat: 21"w 19"d 18.5"-21.5"h | | Arm: 26"-29"h Weight: 60 lbs. | | COM: 3.5 yds. COL: 63 sq.ft. | | | | | | | | | | | | | |
| | | 721-5 | COM | COL | 1 | 2 | 3 | 4 | 5 | 6 | 7 | 8 | 9 | 10 | L1 | L2 | | | | | |

DESCRIPTION:

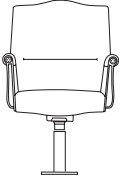
- Upholstery Frames: Hardwood & Plywood
- Seat: High Density Polyurethane Foam Over Sheet Webbing
- Back: High Density Polyurethane Foam Over Polypropylene Webbing
- Upholstered Arms: Exposed Solid Cherry Front Posts w/ Rosette Medallions In Lacquer Finish
- Classic Base Standard
- 10 Year Warranty

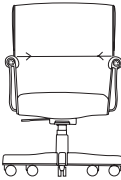
OPTIONS:

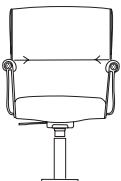
CCM Concentric Arm Medallion (Please Specify)..... N/C
 Specify Exposed Wood Finish (See Page 6)
 Base & Caster Options Available (See Classic Options Pages)



| EXECUTIVE | | ITEM #: | SPECIFICATIONS GRADES LIST PRICES: | | | | | | | | | | | | | | | | | | | | |
|---|---|--------------|--|------------|----------|---|----------|----------|--|----------|----------|----------|----------|-----------|-----------|-----------|--|--|--|--|--|--|--|
|   | <p>LOW BACK CHAIR / OPEN WOOD UPHOLSTERED ARM</p> | | <p>Overall: 25.5"w 29"d 36"-39"h Seat: 21"w 19"d 18.5"-21.5"h</p> | | | <p>Arm: 26"-29"h Weight: 60 lbs.</p> | | | <p>COM: 3 yds. COL: 54 sq.ft.</p> | | | | | | | | | | | | | | |
| | | | COM | COL | 1 | 2 | 3 | 4 | 5 | 6 | 7 | 8 | 9 | 10 | L1 | L2 | | | | | | | |
| | | 722-2 | 1699 | 1869 | 1761 | 1838 | 1915 | 1992 | 2069 | 2146 | 2223 | 2300 | 2377 | 2455 | 2564 | 2842 | | | | | | | |
| <p><i>Tilt Swivel w/ Lock / Pneumatic Seat Height Adjustment / 350 lb. Weight Capacity</i></p> | | | | | | | | | | | | | | | | | | | | | | | |
| | | | COM | COL | 1 | 2 | 3 | 4 | 5 | 6 | 7 | 8 | 9 | 10 | L1 | L2 | | | | | | | |
| 722-4 | 1758 | 1934 | 1817 | 1894 | 1971 | 2048 | 2125 | 2202 | 2279 | 2356 | 2434 | 2511 | 2621 | 2898 | | | | | | | | | |
| <p><i>Knee Tilt Swivel w/ Infinite Lock / Pneumatic Seat Height Adjustment / 350 lb. Weight Capacity</i></p> | | | | | | | | | | | | | | | | | | | | | | | |
|   | <p>LOW BACK JURY CHAIR / OPEN WOOD UPHOLSTERED ARM</p> | | <p>Overall: 25.5"w 29"d 36"-39"h Seat: 21"w 19"d 18.5"-21.5"h</p> | | | <p>Arm: 26"-29"h Weight: 60 lbs.</p> | | | <p>COM: 3 yds. COL: 54 sq.ft.</p> | | | | | | | | | | | | | | |
| | | | COM | COL | 1 | 2 | 3 | 4 | 5 | 6 | 7 | 8 | 9 | 10 | L1 | L2 | | | | | | | |
| | | 722-5 | 1711 | 1882 | 1772 | 1849 | 1926 | 2003 | 2080 | 2157 | 2234 | 2312 | 2389 | 2466 | 2576 | 2853 | | | | | | | |
| <p><i>Tilt Swivel / Pneumatic Seat Height Adjustment / Self-Centering 360° Rotation / 350 lb. Weight Capacity</i></p> | | | | | | | | | | | | | | | | | | | | | | | |
|   | <p>LOW BACK CHAIR / PILLOW BACK / OPEN WOOD UPHOLSTERED ARM</p> | | <p>Overall: 25.5"w 29"d 36"-39"h Seat: 21"w 19"d 18.5"-21.5"h</p> | | | <p>Arm: 26"-29"h Weight: 60 lbs.</p> | | | <p>COM: 3 yds. COL: 54 sq.ft.</p> | | | | | | | | | | | | | | |
| | | | COM | COL | 1 | 2 | 3 | 4 | 5 | 6 | 7 | 8 | 9 | 10 | L1 | L2 | | | | | | | |
| | | 723-2 | 1917 | 2109 | 1995 | 2086 | 2177 | 2268 | 2359 | 2451 | 2542 | 2633 | 2724 | 2815 | 2961 | 3289 | | | | | | | |
| <p><i>Tilt Swivel w/ Lock / Pneumatic Seat Height Adjustment / 350 lb. Weight Capacity</i></p> | | | | | | | | | | | | | | | | | | | | | | | |
| | | | COM | COL | 1 | 2 | 3 | 4 | 5 | 6 | 7 | 8 | 9 | 10 | L1 | L2 | | | | | | | |
| 723-4 | 1977 | 2174 | 2051 | 2142 | 2233 | 2324 | 2415 | 2507 | 2598 | 2689 | 2780 | 2871 | 3017 | 3345 | | | | | | | | | |
| <p><i>Knee Tilt Swivel w/ Infinite Lock / Pneumatic Seat Height Adjustment / 350 lb. Weight Capacity</i></p> | | | | | | | | | | | | | | | | | | | | | | | |
|   | <p>LOW BACK JURY CHAIR / PILLOW BACK / OPEN WOOD UPHOLSTERED ARM</p> | | <p>Overall: 25.5"w 29"d 36"-39"h Seat: 21"w 19"d 18.5"-21.5"h</p> | | | <p>Arm: 26"-29"h Weight: 60 lbs.</p> | | | <p>COM: 3 yds. COL: 54 sq.ft.</p> | | | | | | | | | | | | | | |
| | | | COM | COL | 1 | 2 | 3 | 4 | 5 | 6 | 7 | 8 | 9 | 10 | L1 | L2 | | | | | | | |
| | | 723-5 | 1935 | 2129 | 2012 | 2103 | 2194 | 2285 | 2376 | 2467 | 2558 | 2650 | 2741 | 2832 | 2978 | 3306 | | | | | | | |
| <p><i>Tilt Swivel / Pneumatic Seat Height Adjustment / Self-Centering 360° Rotation / 350 lb. Weight Capacity</i></p> | | | | | | | | | | | | | | | | | | | | | | | |

DESCRIPTION:

- Exposed Frames: Solid Cherry
- Seat: High Density Polyurethane Foam Over Sheet Webbing
- Back: High Density Polypropylene Webbing
- Fully Upholstered Arms: High Density Polyurethane Foam Over Hardwood
- Rosette Arm & Back Post Medallions Standard
- 10 Year Warranty

OPTIONS:

CCM Concentric Arm Medallion (Please Specify)..... N/C
 Specify Exposed Wood Finish (See Page 6)

| GUEST | ITEM #: | SPECIFICATIONS GRADES LIST PRICES: | | | | | | | | | | | | | |
|---|---------|--|------------|------------------------|----------|-------------------------|----------|----------|----------|----------|----------|----------|-----------|-----------|-----------|
| CLOSED ARM SIDE CHAIR  | 760 | Overall: 23.75"w 25.5"d 33.5"h | | Arm: 26"h | | COM: 2.75 yds. | | | | | | | | | |
| | | Seat: 20.25"w 18.5"d 19"h | | Weight: 38 lbs. | | COL: 49.5 sq.ft. | | | | | | | | | |
| | | COM | COL | 1 | 2 | 3 | 4 | 5 | 6 | 7 | 8 | 9 | 10 | L1 | L2 |
| | | 1444 | 1589 | 1506 | 1576 | 1646 | 1716 | 1786 | 1856 | 1926 | 1996 | 2067 | 2137 | 2237 | 2489 |
| | | <i>Closed Back / 350 lb. Weight Capacity</i> | | | | | | | | | | | | | |
| OPEN ARM SIDE CHAIR  | 770 | Overall: 23.75"w 25.5"d 33.5"h | | Arm: 26"h | | COM: 2.5 yds. | | | | | | | | | |
| | | Seat: 20.25"w 18.5"d 19"h | | Weight: 32 lbs. | | COL: 45 sq.ft. | | | | | | | | | |
| | | COM | COL | 1 | 2 | 3 | 4 | 5 | 6 | 7 | 8 | 9 | 10 | L1 | L2 |
| | | 1408 | 1549 | 1458 | 1521 | 1584 | 1647 | 1710 | 1773 | 1836 | 1899 | 1962 | 2026 | 2111 | 2338 |
| | | <i>Open Back / 350 lb. Weight Capacity</i> | | | | | | | | | | | | | |
| ARMLESS SIDE CHAIR  | 780 | Overall: 21"w 25.5"d 33.5"h | | Arm: n/a | | COM: 2.5 yds. | | | | | | | | | |
| | | Seat: 20.25"w 18.5"d 19"h | | Weight: 30 lbs. | | COL: 45 sq.ft. | | | | | | | | | |
| | | COM | COL | 1 | 2 | 3 | 4 | 5 | 6 | 7 | 8 | 9 | 10 | L1 | L2 |
| | | 972 | 1069 | 1045 | 1108 | 1171 | 1234 | 1297 | 1360 | 1423 | 1487 | 1550 | 1613 | 1684 | 1911 |
| | | <i>Open Back / 350 lb. Weight Capacity</i> | | | | | | | | | | | | | |

DESCRIPTION:

- Upholstery Frames: Plywood & Hardwood
- Seat: High Density Polyurethane Foam Over Sheet Webbing
- Tight Seat: High Density Polyurethane Foam
- Back: High Density Polyurethane Foam Over Polypropylene Webbing
- Loose Cushions: High Density Polydacron
- Leather / Vinyl Cushions Are Not Reversible
- Exposed Wood Legs: Solid Cherry
- 10 Year Warranty

OPTIONS:

- PM1 Power/Data Module (1-Power / 1-USB 2 Port Simplex Charger)\$859
- PM2 Power Module (1-Power).....\$238
- USB-1 USB In Back (2 Ports Available - Specify Left or Right Facing).....\$238

Feather Down & Polyester Pillows Available (See Page 5)
Specify Exposed Wood Finish (See Page 6)

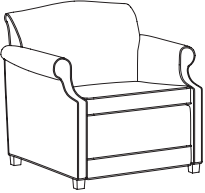
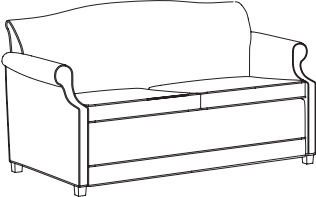
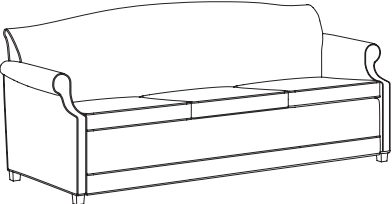
| LOUNGE | | ITEM #: | SPECIFICATIONS GRADES LIST PRICES: | | | | | | | | | | | | |
|--|-------|----------------------------------|--|---|----------|----------|----------|----------|----------|----------|----------|----------|-----------|-----------|-----------|
|  | 790-C | Overall: 33"w 33.5"d 34"h | Arm: 24.5"h | COM: 5.75 yds. (790-P) / 6.75 yds. (790-C) | | | | | | | | | | | |
| | | Seat: 22"w 20.5"d 18.5"h | Weight: 65 lbs. | COL: 103.5 sq.ft. (790-P) / 121.5 sq.ft. (790-C) | | | | | | | | | | | |
| | | COM | COL | 1 | 2 | 3 | 4 | 5 | 6 | 7 | 8 | 9 | 10 | L1 | L2 |
| | | 1767 | 1943 | 2035 | 2217 | 2399 | 2581 | 2764 | 2946 | 3128 | 3310 | 3493 | 3675 | 3896 | 4552 |
| <i>Reversible Loose Seat Cushion / Tight Back / 500 lb. Weight Capacity</i> | | | | | | | | | | | | | | | |
|  | 793-C | Overall: 59"w 33.5"d 34"h | Arm: 24.5"h | COM: 7.5 yds. (793-P) / 9.75 yds. (793-C) | | | | | | | | | | | |
| | | Seat: 48"w 20.5"d 18.5"h | Weight: 100 lbs. | COL: 135 sq.ft. (793-P) / 175.5 sq.ft. (793-C) | | | | | | | | | | | |
| | | COM | COL | 1 | 2 | 3 | 4 | 5 | 6 | 7 | 8 | 9 | 10 | L1 | L2 |
| | | 2420 | 2662 | 2821 | 3087 | 3354 | 3620 | 3887 | 4153 | 4419 | 4686 | 4952 | 5218 | 5522 | 6480 |
| <i>Reversible Loose Seat Cushions / Tight Back / 750 lb. Weight Capacity</i> | | | | | | | | | | | | | | | |
|  | 796-C | Overall: 80"w 33.5"d 34"h | Arm: 24.5"h | COM: 10 yds. (796-P) / 11.25 yds. (796-C) | | | | | | | | | | | |
| | | Seat: 69"w 20.5"d 18.5"h | Weight: 158 lbs. | COL: 180 sq.ft. (796-P) / 202.5 sq.ft. (796-C) | | | | | | | | | | | |
| | | COM | COL | 1 | 2 | 3 | 4 | 5 | 6 | 7 | 8 | 9 | 10 | L1 | L2 |
| | | 3002 | 3302 | 3455 | 3763 | 4072 | 4380 | 4689 | 4997 | 5305 | 5614 | 5922 | 6231 | 6593 | 7703 |
| <i>Reversible Loose Seat Cushion / Tight Back / 1000 lb. Weight Capacity</i> | | | | | | | | | | | | | | | |

DESCRIPTION:



- Upholstery Seat: High Density Polyurethane Foam Over Sheet Webbing
- Solid Cherry Legs & Apron
- Rosette Medallions Standard
- 10 Year Warranty

OPTIONS:

CCM Concentric Circle Medallion (Please Specify)..... N/C

Specify Exposed Wood Finish (See Page 6)

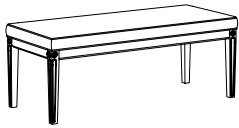
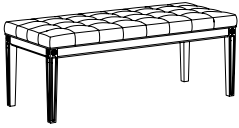
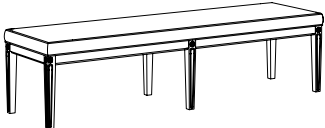
Note: Trinity Must Approve Specific Fabrics / Leathers Used For Tufting.

| BENCHES | | ITEM #: | SPECIFICATIONS GRADES LIST PRICES: | | | | | | | | | | | | | |
|--|--|--------------|--|------------|----------|------------------------|----------|----------|---|----------|----------|----------|----------|-----------|-----------|-----------|
|  <p>748-P</p>  <p>748-T</p> | | | Overall: 48"w 20"d 19"h | | | Arm: n/a | | | COM: 2.25 yds. (748-P / 748-T) | | | | | | | |
| | | | Seat: 19"h | | | Weight: 48 lbs. | | | COL: 40.5 sq.ft. (748-P / 748-T) | | | | | | | |
| | | | COM | COL | 1 | 2 | 3 | 4 | 5 | 6 | 7 | 8 | 9 | 10 | L1 | L2 |
| | | 748-P | 950 | 1045 | 1011 | 1067 | 1123 | 1179 | 1235 | 1291 | 1347 | 1403 | 1459 | 1515 | 1586 | 1788 |
| | | | <i>Plain Upholstered / 750 lb. Weight Capacity</i> | | | | | | | | | | | | | |
| | | 748-T | 1351 | 1486 | 1390 | 1446 | 1502 | 1558 | 1614 | 1670 | 1726 | 1782 | 1838 | 1894 | 2017 | 2219 |
| | | | <i>Button Tufted Upholstered / 750 lb. Weight Capacity</i> | | | | | | | | | | | | | |
|  <p>772-P</p>  <p>772-T</p> | | | Overall: 72"w 20"d 19"h | | | Arm: n/a | | | COM: 3 yds. (772-P) / 2.5 yds. (772-T) | | | | | | | |
| | | | Seat: 19"h | | | Weight: 60 lbs. | | | COL: 54 sq.ft. (772-P) / 45 sq.ft. (772-T) | | | | | | | |
| | | | COM | COL | 1 | 2 | 3 | 4 | 5 | 6 | 7 | 8 | 9 | 10 | L1 | L2 |
| | | 772-P | 1429 | 1572 | 1465 | 1540 | 1615 | 1690 | 1765 | 1841 | 1916 | 1991 | 2066 | 2141 | 2238 | 2509 |
| | | | <i>Plain Upholstered / 750 lb. Weight Capacity</i> | | | | | | | | | | | | | |
| | | 772-T | 1842 | 2027 | 1868 | 1931 | 1994 | 2057 | 2120 | 2183 | 2247 | 2310 | 2373 | 2436 | 2592 | 2819 |
| | | | <i>Button Tufted Upholstered / 750 lb. Weight Capacity</i> | | | | | | | | | | | | | |

DESCRIPTION:



- Solid Cherry Legs & Apron
- Cherry Veneer Top Is Banded With Solid Cherry / Ebony Inlay Top
- Rosette Medallions Standard
- 10 Year Warranty

OPTIONS:

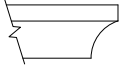
CCM Concentric Circle Medallion (Please Specify)..... N/C
 Specify Exposed Wood Finish (See Page 6)



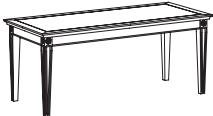



Classic Edge Profile Standard

| TABLES | ITEM #: | SPECIFICATIONS GRADES LIST PRICES: | | | | | | | | | | | | | | |
|--|---------|---|-----|---|---|---|---|---|---|---|---|---|----|----|----|--|
| <p>END TABLE</p>  | | <p>Overall: 20"w 24"d 23"h Weight: 40 lbs.</p> | | | | | | | | | | | | | | |
| | | COM | COL | 1 | 2 | 3 | 4 | 5 | 6 | 7 | 8 | 9 | 10 | L1 | L2 | |
| | 7020-L | | | | | | | | | | | | | | | |
| | | | | | | | | | | | | | | | | |
| | 7020-V | | | | | | | | | | | | | | | |
| | | | | | | | | | | | | | | | | |
| <p>COFFEE TABLE</p>  | | <p>Overall: 42"w 20"d 18"h Weight: 42 lbs.</p> | | | | | | | | | | | | | | |
| | | COM | COL | 1 | 2 | 3 | 4 | 5 | 6 | 7 | 8 | 9 | 10 | L1 | L2 | |
| | 7042-L | | | | | | | | | | | | | | | |
| | | | | | | | | | | | | | | | | |
| | 7042-V | | | | | | | | | | | | | | | |
| | | | | | | | | | | | | | | | | |
| <p>SOFA TABLE</p>  | | <p>Overall: 48"w 18"d 30"h Weight: 53 lbs.</p> | | | | | | | | | | | | | | |
| | | COM | COL | 1 | 2 | 3 | 4 | 5 | 6 | 7 | 8 | 9 | 10 | L1 | L2 | |
| | 7048-L | | | | | | | | | | | | | | | |
| | | | | | | | | | | | | | | | | |
| | 7048-V | | | | | | | | | | | | | | | |
| | | | | | | | | | | | | | | | | |

| BASES | OPTION #: | SPECIFICATIONS LIST PRICES AVAILABILITY: |
|--|--|---|
| <p data-bbox="94 176 326 205">TRANSITIONAL WOOD BASE</p>  | <p data-bbox="509 268 558 298">TWB</p> | <p data-bbox="581 176 781 205">Overall: 25"w 25"d 5.5"h</p> <hr/> <p data-bbox="581 268 1214 344">No Charge \$193 Upcharge From Resin To Wood Base (730, 740, 750 Task Chairs Only) <i>Solid Hardwood Cap, Steel Reinforced 5 Prong Base With 55mm Black Dual Wheel Casters.</i></p> <p data-bbox="581 369 1179 445"> OPTIONS: C1 Carpet Caster - 2" Metal Balls \$200 (Set Of 5) C2 Antique Bronze Hooded Caster - 2" Rubber Ball \$152 (Set Of 5) C3 Brass Hooded Black Caster - 2" Dual Wheels \$95 (Set Of 5) </p> <p data-bbox="581 487 854 516">Available: <i>Classic Executive Seating</i></p> |
| <p data-bbox="94 638 277 667">CLASSIC WOOD BASE</p>  | <p data-bbox="509 730 558 760">CWB</p> | <p data-bbox="581 638 764 667">Overall: 28"w 28"d 5"h</p> <hr/> <p data-bbox="581 730 1214 806">Standard - No Charge \$193 Upcharge From Resin To Wood Base (730, 740, 750 Task Chairs Only) <i>Solid Hardwood Cap, Steel Reinforced 5 Prong Base With 55mm Black Dual Wheel Casters.</i></p> <p data-bbox="581 831 1179 928"> OPTIONS: C1 Carpet Caster - 2" Metal Balls \$200 (Set Of 5) C2 Antique Bronze Hooded Caster - 2" Rubber Ball \$152 (Set Of 5) C3 Brass Hooded Black Caster - 2" Dual Wheels \$95 (Set Of 5) SP Brass Scuff Plates \$121 (Set Of 5) </p> <p data-bbox="581 970 854 999">Available: <i>Classic Executive Seating</i></p> |
| <p data-bbox="94 1100 272 1129">ARCHED RESIN BASE</p>  | <p data-bbox="509 1192 558 1222">ARB</p> | <p data-bbox="581 1100 789 1129">Overall: 27"w 27"d 6.25"h</p> <hr/> <p data-bbox="581 1192 1105 1247">\$50 Deduct <i>Black Reinforced Nylon 5 Prong Base With 55mm Black Dual Wheel Casters.</i></p> <p data-bbox="581 1272 1235 1302"> OPTIONS: C4 Black Sculptured Glides No Upcharge (Set Of 5) </p> <p data-bbox="581 1344 854 1373">Available: <i>Classic Executive Seating</i></p> |
| <p data-bbox="94 1562 326 1591">POLISHED ALUMINUM BASE</p>  | <p data-bbox="509 1654 558 1684">PAB</p> | <p data-bbox="581 1562 764 1591">Overall: 26"w 26"d 8"h</p> <hr/> <p data-bbox="581 1654 1073 1709">\$25 Deduct <i>Polished Aluminum 5 Prong Base With 55mm Black Dual Wheel Casters</i></p> <p data-bbox="581 1734 1235 1789"> OPTIONS: C4 Black Sculptured Glides No Upcharge (Set Of 5) C5 Polished Aluminum Hooded Casters \$105 (Set Of 5) </p> <p data-bbox="581 1831 854 1860">Available: <i>Classic Executive Seating</i></p> |

| BASES / CASTERS | OPTION #: | SPECIFICATIONS LIST PRICES AVAILABILITY: |
|---|--|--|
| <p>HIGH PROFILE BASE</p>  | <p>HPB</p> | <p>Overall: 26"w 26"d 8"h</p> <hr/> <p>\$50 Deduct <i>Black Reinforced Nylon 5 Prong Base With 55mm Black Dual Wheel Casters</i></p> <p>Available: <i>Classic Executive Seating</i></p> |
| <p>TAPERED RESIN BASE</p>  | <p>TRB</p> | <p>Overall: 25.5"w 25.5"d 5"h</p> <hr/> <p>Standard On 730, 740, 750 - No Charge Classic To Tapered Resin Base - Deduct \$47 <i>Black Reinforced Nylon 5 Prong Base With 55mm Black Dual Wheel Casters.</i></p> <p>Available: <i>Classic Executive Seating</i></p> |
| <p>JURY BASE</p>  | <p>JRB</p> | <p>Overall: 8.5" Diameter 3.75"h</p> <hr/> <p>\$200 <i>360° Rotation, Self Centering With Pneumatic Height Adjustment</i></p> <p>OPTIONS: No Rotation</p> <p>Available: <i>Classic Executive Seating</i></p> |
| <p>CASTERS</p> <div style="display: flex; flex-wrap: wrap;"> <div style="width: 50%;">  <p>(C1) Carpet Caster - 2" Metal Balls</p> </div> <div style="width: 50%;">  <p>(C2) Antique Bronze Hooded Caster - 2" Rubber Ball</p> </div> <div style="width: 50%;">  <p>(C3) Brass Hooded Black Caster - 2" Dual Wheels</p> </div> <div style="width: 50%;">  <p>(C4) Black Sculptured Glide - 2" Flat Bottom Glide</p> </div> <div style="width: 50%;">  <p>(C5) Polished Aluminum Caster - 2" Dual Wheels</p> </div> </div> | <p>Overall: 2"h</p> <hr/> <p>C1 \$200 (Set Of 5) <i>Carpet Caster - 2" Metal Balls - Antique Windsor (Additional Finishes Available)</i></p> <p>C2 \$152 (Set Of 5) <i>Antique Bronze Hooded Caster - 2" Rubber Ball (Additional Finishes Available)</i></p> <p>C3 \$95 (Set Of 5) <i>Brass Hooded Black Caster - 2" Dual Wheels (Additional Finishes Available)</i></p> <p>C4 No Charge (Set Of 5) <i>Black Sculptured Glide - 2" Flat Bottom Glide</i></p> <p>C5 \$105 (Set Of 5) <i>Polished Aluminum Hooded Caster - 2" Dual Wheels</i></p> <p>Available: <i>Classic Executive Seating</i></p> | |

| SCUFF PLATES / LUMBAR / MEDALLIONS | OPTION #: | SPECIFICATIONS LIST PRICES AVAILABILITY: |
|--|---|--|
| <p>SCUFF PLATES</p>  | <p>Overall: 1"w 4"d</p> <hr/> <p>SP \$121 (Set Of 5) <i>(Specify Brass Or Pewter)</i></p> <p>Available: Classic Base Only</p> | |
| <p>INFLATABLE LUMBAR</p>  | <p>Overall: 2"w 3.75"h</p> <hr/> <p>IL \$285 <i>Side Lever Lifts to Inflate & Deflate Lumbar</i></p> <p>Available: Classic Executive Seating (700, 701, 710, 711 Models)</p> | |
| <p>CONCENTRIC CIRCLE ARM MEDALLIONS</p>  | <p>Overall: 1.25" Diameter</p> <hr/> <p>CCM No Charge <i>(Specify Finish)</i></p> <p>Available: Classic Executive, Guest, And Benches</p> | |

| POWER / COVERS | OPTION #: | SPECIFICATIONS LIST PRICES AVAILABILITY: |
|--|---|--|
| <p>POWER / DATA MODULE</p>  <p>PM1 Power / Data Module</p>  <p>PM2 Power Module</p>  <p>USB-1 Dual Charging USB</p> | <p>PM1</p> <p>PM2</p> <p>USB-1</p> | <p>PM1 Overall: 5.25"w 1.25"d 4.25"h PM2 Overall: 2"w 2"d .125"h USB-1 Overall: 2"w 2"d .125"h</p> <p>\$859 Power/Data Module (1-Power / 1-USB 2 Port Simplex Charger Standard) <i>Vertical / Horizontal Mount Power Module. Price Varies By Socket. Contact Customer Service For Quote. (Additional Colors Available)</i></p> <p>\$238 Power Module (1-Power) <i>Spill-Proof Technology / Multiple Finish Options / Storm Color Standard (Specify Left or Right Facing)</i></p> <p>\$238 Dual Charging USB (2 Port Simplex Charger Standard) <i>Spill-Proof Technology / 2 Amps Per Port / Multiple Finish Options / Storm Color Standard (Specify Left or Right Facing)</i></p> <p>Available: Classic Lounge</p> |
| <p>CONTRASTING COVERS</p>  | <p>CC</p> | <p>Overall: n/a</p> <p>\$129 <i>NOTE: If Two Or More Upholsteries Or Leathers Are Used On Any Piece Of Furniture, Then A Contrast Charge Will Apply Per Order. When Using Trinity Upholstery, The Higher Priced Upholstery Grade Will Be Used In Pricing, Unless It's Trinity Leather With Fabric Contrast Welt, Or COM With Trinity Contrast Welt, Then Contact Customer Service For Pricing.</i></p> <p>Available: Classic Collection</p> |

Langton

EXECUTIVE / GUEST

Effective: March 1, 2025

T R I N I T Y

Date:

Page:

Modification:

Description:

DESCRIPTION:

- Upholstery Frames: Hardwood & Plywood
- Seat: High Density Polyurethane Foam Over Sheet Webbing
- Back: High Density Polyurethane Foam Over Polypropylene Webbing
- Arms: High Density Polyurethane Foam Over Hardwood & Plywood
- Black Arched Resin Base Standard
- 10 Year Warranty

OPTIONS:

Specify Exposed Wood Finish (See Page 6)
 Base & Caster Options Available (See Langton Options Pages)

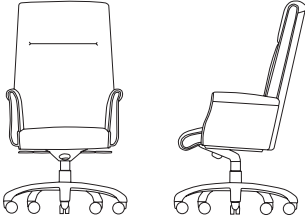
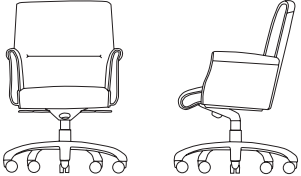
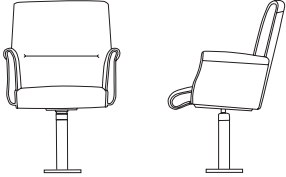
| EXECUTIVE | | ITEM #: | SPECIFICATIONS GRADES LIST PRICES: | | | | | | | | | | | | |
|--|--------------|--|--|------------|----------|------------------------|----------|----------|-----------------------|----------|----------|----------|----------|-----------|-----------|
| HIGH BACK CHAIR / FULLY UPHOLSTERED ARMS  | | | <i>Overall: 25"w 28"d 47"-50"h</i> | | | <i>Arm: 28"-31"h</i> | | | <i>COM: 4 yds.</i> | | | | | | |
| | | | <i>Seat: 19"w 20"d 20.5"-23.5"h</i> | | | <i>Weight: 80 lbs.</i> | | | <i>COL: 72 sq.ft.</i> | | | | | | |
| | | | COM | COL | 1 | 2 | 3 | 4 | 5 | 6 | 7 | 8 | 9 | 10 | L1 |
| | 811-3 | 1482 | 1630 | 1618 | 1726 | 1834 | 1942 | 2051 | 2159 | 2267 | 2375 | 2483 | 2592 | 2748 | 3138 |
| | | <i>Tilt Swivel Infinite Lock / Pneumatic Seat Height Adjustment / 350 lb. Weight Capacity</i> | | | | | | | | | | | | | |
| | 811-4 | 1500 | 1650 | 1635 | 1743 | 1851 | 1960 | 2068 | 2176 | 2284 | 2393 | 2501 | 2609 | 2765 | 3155 |
| | | <i>Knee Tilt Swivel w/ Infinite Lock / Pneumatic Seat Height Adjustment / 350 lb. Weight Capacity</i> | | | | | | | | | | | | | |
| LOW BACK CHAIR / FULLY UPHOLSTERED ARMS  | | | <i>Overall: 25"w 28"d 40"-43"h</i> | | | <i>Arm: 28"-31"h</i> | | | <i>COM: 3.75 yds.</i> | | | | | | |
| | | | <i>Seat: 19"w 20"d 20.5"-23.5"h</i> | | | <i>Weight: 70 lbs.</i> | | | <i>COL: 68 sq.ft.</i> | | | | | | |
| | | | COM | COL | 1 | 2 | 3 | 4 | 5 | 6 | 7 | 8 | 9 | 10 | L1 |
| | 821-2 | 1323 | 1455 | 1453 | 1554 | 1655 | 1756 | 1857 | 1958 | 2059 | 2160 | 2261 | 2362 | 2501 | 2864 |
| | | <i>Tilt Swivel w/ Lock / Pneumatic Seat Height Adjustment / 350 lb. Weight Capacity</i> | | | | | | | | | | | | | |
| | 821-4 | 1384 | 1522 | 1511 | 1612 | 1713 | 1814 | 1915 | 2016 | 2117 | 2218 | 2319 | 2420 | 2558 | 2922 |
| | | <i>Knee Tilt Swivel w/ Infinite Lock / Pneumatic Seat Height Adjustment / 350 lb. Weight Capacity</i> | | | | | | | | | | | | | |
| LOW BACK JURY CHAIR / FULLY UPHOLSTERED ARMS  | | | <i>Overall: 25"w 28"d 40"-43"h</i> | | | <i>Arm: 28"-31"h</i> | | | <i>COM: 3.75 yds.</i> | | | | | | |
| | | | <i>Seat: 19"w 20"d 20.5"-23.5"h</i> | | | <i>Weight: 70 lbs.</i> | | | <i>COL: 68 sq.ft.</i> | | | | | | |
| | | | COM | COL | 1 | 2 | 3 | 4 | 5 | 6 | 7 | 8 | 9 | 10 | L1 |
| | 821-5 | 1525 | 1677 | 1643 | 1744 | 1845 | 1946 | 2047 | 2149 | 2250 | 2351 | 2452 | 2553 | 2691 | 3055 |
| | | <i>Tilt Swivel / Pneumatic Seat Height Adjustment / Self-Centering 360° Rotation / 350 lb. Weight Capacity</i> | | | | | | | | | | | | | |

DESCRIPTION:





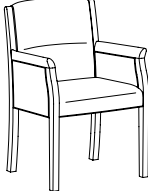
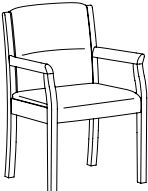
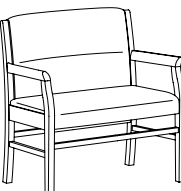

- Exposed Frames: Solid Cherry
- Seat: High Density Polyurethane Foam Over Sheet Webbing
- Back: High Density Polyurethane Foam Over Polypropylene Webbing
- Upholstered Arms: High Density Polyurethane Foam Over Hardwood
- 10 Year Warranty



OPTIONS:

Specify Exposed Wood Finish (See Page 6)

| GUEST | ITEM #: | SPECIFICATIONS GRADES LIST PRICES: | | | | | | | | | | | | | |
|---|---------|--|------------|------------------------|----------|-----------------------|----------|----------|----------|----------|----------|----------|-----------|-----------|-----------|
| CLOSED ARM SIDE CHAIR  | 823 | Overall: 22.5"w 24"d 33"h | | Arm: 25"h | | COM: 2.25 yds. | | | | | | | | | |
| | | Seat: 19"w 18"d 19"h | | Weight: 38 lbs. | | COL: 41 sq.ft. | | | | | | | | | |
| | | COM | COL | 1 | 2 | 3 | 4 | 5 | 6 | 7 | 8 | 9 | 10 | L1 | L2 |
| | | 1172 | 1289 | 1224 | 1281 | 1339 | 1397 | 1455 | 1512 | 1570 | 1628 | 1685 | 1743 | 1823 | 2031 |
| <i>Closed Back / Solid Wood Arms / 350 lb. Weight Capacity</i> | | | | | | | | | | | | | | | |
| OPEN ARM SIDE CHAIR  | 824 | Overall: 22.5"w 24"d 33"h | | Arm: 25"h | | COM: 1.75 yds. | | | | | | | | | |
| | | Seat: 19"w 18"d 19"h | | Weight: 32 lbs. | | COL: 32 sq.ft. | | | | | | | | | |
| | | COM | COL | 1 | 2 | 3 | 4 | 5 | 6 | 7 | 8 | 9 | 10 | L1 | L2 |
| | | 1086 | 1195 | 1113 | 1157 | 1200 | 1243 | 1287 | 1330 | 1373 | 1417 | 1460 | 1503 | 1563 | 1719 |
| <i>Closed Back / Solid Wood Arms / 350 lb. Weight Capacity</i> | | | | | | | | | | | | | | | |
| BARIATRIC / OPEN ARM SIDE CHAIR  | 824-X | Overall: 32.5"w 24"d 33"h | | Arm: 25"h | | COM: 1.75 yds. | | | | | | | | | |
| | | Seat: 29"w 18"d 19"h | | Weight: 42 lbs. | | COL: 32 sq.ft. | | | | | | | | | |
| | | COM | COL | 1 | 2 | 3 | 4 | 5 | 6 | 7 | 8 | 9 | 10 | L1 | L2 |
| | | 1330 | 1463 | 1344 | 1387 | 1431 | 1474 | 1517 | 1560 | 1604 | 1647 | 1690 | 1734 | 1796 | 1952 |
| <i>Closed Back / Solid Wood Arms / 350 lb. Weight Capacity</i> | | | | | | | | | | | | | | | |

| BASES | OPTION #: | SPECIFICATIONS LIST PRICES AVAILABILITY: | | | | | | | | |
|---|------------------------|---|-----------------------------------|------------------------|--|------------------|---|-----------------|-----------------------|------------------|
| <p>TRANSITIONAL WOOD BASE</p>  | <p>TWB</p> | <p>Overall: 25"w 25"d 5.5"h</p> <hr/> <p>\$237 Solid Hardwood Cap, Steel Reinforced 5 Prong Base With 55mm Black Dual Wheel Casters.</p> <p>OPTIONS:</p> <table border="0"> <tr> <td>C1 Carpet Caster - 2" Metal Balls</td> <td>\$200 (Set Of 5)</td> </tr> <tr> <td>C2 Antique Bronze Hooded Caster - 2" Rubber Ball</td> <td>\$152 (Set Of 5)</td> </tr> <tr> <td>C3 Brass Hooded Black Caster - 2" Dual Wheels</td> <td>\$95 (Set Of 5)</td> </tr> </table> <p>Available: Langton Executive Seating</p> | C1 Carpet Caster - 2" Metal Balls | \$200 (Set Of 5) | C2 Antique Bronze Hooded Caster - 2" Rubber Ball | \$152 (Set Of 5) | C3 Brass Hooded Black Caster - 2" Dual Wheels | \$95 (Set Of 5) | | |
| C1 Carpet Caster - 2" Metal Balls | \$200 (Set Of 5) | | | | | | | | | |
| C2 Antique Bronze Hooded Caster - 2" Rubber Ball | \$152 (Set Of 5) | | | | | | | | | |
| C3 Brass Hooded Black Caster - 2" Dual Wheels | \$95 (Set Of 5) | | | | | | | | | |
| <p>CLASSIC WOOD BASE</p>  | <p>CWB</p> | <p>Overall: 28"w 28"d 5"h</p> <hr/> <p>\$237 Solid Hardwood Cap, Steel Reinforced 5 Prong Base With 55mm Black Dual Wheel Casters.</p> <p>OPTIONS:</p> <table border="0"> <tr> <td>C1 Carpet Caster - 2" Metal Balls</td> <td>\$200 (Set Of 5)</td> </tr> <tr> <td>C2 Antique Bronze Hooded Caster - 2" Rubber Ball</td> <td>\$152 (Set Of 5)</td> </tr> <tr> <td>C3 Brass Hooded Black Caster - 2" Dual Wheels</td> <td>\$95 (Set Of 5)</td> </tr> <tr> <td>SP Brass Scuff Plates</td> <td>\$121 (Set Of 5)</td> </tr> </table> <p>Available: Langton Executive Seating</p> | C1 Carpet Caster - 2" Metal Balls | \$200 (Set Of 5) | C2 Antique Bronze Hooded Caster - 2" Rubber Ball | \$152 (Set Of 5) | C3 Brass Hooded Black Caster - 2" Dual Wheels | \$95 (Set Of 5) | SP Brass Scuff Plates | \$121 (Set Of 5) |
| C1 Carpet Caster - 2" Metal Balls | \$200 (Set Of 5) | | | | | | | | | |
| C2 Antique Bronze Hooded Caster - 2" Rubber Ball | \$152 (Set Of 5) | | | | | | | | | |
| C3 Brass Hooded Black Caster - 2" Dual Wheels | \$95 (Set Of 5) | | | | | | | | | |
| SP Brass Scuff Plates | \$121 (Set Of 5) | | | | | | | | | |
| <p>ARCHED RESIN BASE</p>  | <p>ARB</p> | <p>Overall: 27"w 27"d 6.25"h</p> <hr/> <p>Standard - No Charge Black Reinforced Nylon 5 Prong Base With 55mm Black Dual Wheel Casters.</p> <p>OPTIONS:</p> <table border="0"> <tr> <td>C4 Black Sculptured Glides</td> <td>No Upcharge</td> </tr> </table> <p>Available: Langton Executive Seating</p> | C4 Black Sculptured Glides | No Upcharge | | | | | | |
| C4 Black Sculptured Glides | No Upcharge | | | | | | | | | |
| <p>POLISHED ALUMINUM BASE</p>  | <p>PAB</p> | <p>Overall: 26"w 26"d 8"h</p> <hr/> <p>\$120 Polished Aluminum 5 Prong Base With 55mm Black Dual Wheel Casters</p> <p>OPTIONS:</p> <table border="0"> <tr> <td>C4 Black Sculptured Glides</td> <td>No Upcharge (Set Of 5)</td> </tr> <tr> <td>C5 Polished Aluminum Hooded Casters</td> <td>\$105 (Set Of 5)</td> </tr> </table> <p>Available: Langton Executive Seating</p> | C4 Black Sculptured Glides | No Upcharge (Set Of 5) | C5 Polished Aluminum Hooded Casters | \$105 (Set Of 5) | | | | |
| C4 Black Sculptured Glides | No Upcharge (Set Of 5) | | | | | | | | | |
| C5 Polished Aluminum Hooded Casters | \$105 (Set Of 5) | | | | | | | | | |

| BASES / CASTERS | OPTION #: | SPECIFICATIONS LIST PRICES AVAILABILITY: |
|---|--|--|
| <p>HIGH PROFILE BASE</p>  | <p>HPB</p> <p>No Charge <i>Black Reinforced Nylon 5 Prong Base With 55mm Black Dual Wheel Casters</i></p> <p><i>Available: Langton Executive Seating</i></p> | |
| <p>JURY BASE</p>  | <p>JRB</p> <p><i>Overall: 8.5" Diameter 3.75"h</i></p> <p>\$200 <i>360° Rotation, Self Centering With Pneumatic Height Adjustment</i></p> <p>OPTIONS: No Rotation</p> <p><i>Available: Langton Executive Seating</i></p> | |
| <p>CASTERS</p> <div style="display: flex; flex-wrap: wrap;"> <div style="width: 50%;">  <p>(C1) Carpet Caster - 2" Metal Balls</p> </div> <div style="width: 50%;">  <p>(C2) Antique Bronze Hooded Caster - 2" Rubber Ball</p> </div> <div style="width: 50%;">  <p>(C3) Brass Hooded Black Caster - 2" Dual Wheels</p> </div> <div style="width: 50%;">  <p>(C4) Black Sculptured Glide - 2" Flat Bottom Glide</p> </div> <div style="width: 50%;">  <p>(C5) Polished Aluminum Caster - 2" Dual Wheels</p> </div> </div> | <p><i>Overall: 2"h</i></p> <p>C1 \$200 (Set Of 5) <i>Carpet Caster - 2" Metal Balls - Antique Windsor (Additional Finishes Available)</i></p> <p>C2 \$152 (Set Of 5) <i>Antique Bronze Hooded Caster - 2" Rubber Ball (Additional Finishes Available)</i></p> <p>C3 \$95 (Set Of 5) <i>Brass Hooded Black Caster - 2" Dual Wheels (Additional Finishes Available)</i></p> <p>C4 No Charge (Set Of 5) <i>Black Sculptured Glide - 2" Flat Bottom Glide</i></p> <p>C5 \$105 (Set Of 5) <i>Polished Aluminum Hooded Caster - 2" Dual Wheels</i></p> <p><i>Available: Langton Executive Seating</i></p> | |

| SCUFF PLATES / COVERS | OPTION #: | SPECIFICATIONS LIST PRICES AVAILABILITY: |
|--|---|--|
| <p>SCUFF PLATES</p>  | <p>Overall: 1"w 4"d</p> <hr/> <p>SP \$121 (Set Of 5) <i>(Specify Brass Or Pewter)</i></p> <p>Available: <i>Classic Base Only</i></p> | |
| <p>CONTRASTING COVERS</p>  | <p>Overall: n/a</p> <hr/> <p>CC \$129</p> <p><i>NOTE: If Two Or More Upholsteries Or Leathers Are Used On Any Piece Of Furniture, Then A Contrast Charge Will Apply Per Order. When Using Trinity Upholstery, The Higher Priced Upholstery Grade Will Be Used In Pricing, Unless It's Trinity Leather With Fabric Contrast Welt, Or COM With Trinity Contrast Welt, Then Contact Customer Service For Pricing.</i></p> <p>Available: <i>Langton Chairs</i></p> | |

Luci Guci

LOUNGE / EXECUTIVE / GUEST

Effective: March 1, 2025

T R I N I T Y

Date:

Page:

Modification:

Description:

DESCRIPTION:

- Upholstery Frames: Plywood & Hardwood
- Seat / Back: High Density Polyurethane Foam
- Upholstered Arms: High Density Polyurethane Foam Over Plywood & Hardwood
- Open Arm: Black Urethane Molded Over A Steel Armature
(All Arms Are Attached & Reinforced w/ Steel)
- Built-in Upholstered Lumbar
- Black Arched Resin Base Standard
- 10 Year Warranty

OPTIONS:

Specify Exposed Wood Finish (See Page 6)
Base & Caster Options Available (See Luci Guci Options Pages)

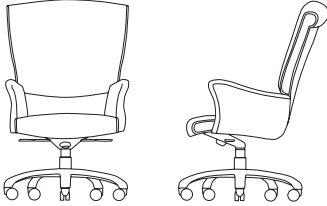
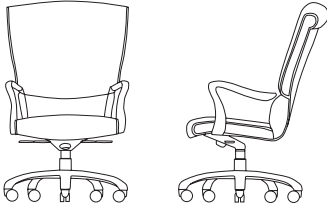
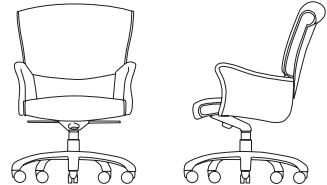
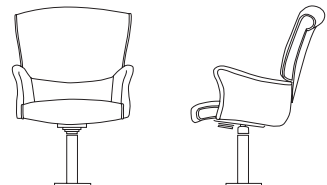
| EXECUTIVE | | ITEM #: | SPECIFICATIONS GRADES LIST PRICES: | | | | | | | | | | | | |
|---|--------------|--|---|------------|----------|--------------------------|----------|----------|-----------------------|----------|----------|----------|----------|-----------|-----------|
|  | | | Overall: 26"w 30"d 43"-46"h | | | Arm: 25.5"-28.5"h | | | COM: 3.25 yds. | | | | | | |
| | | | Seat: 22.5"w 18.5"d 17.5"-20.5"h | | | Weight: 65 lbs. | | | COL: 59 sq.ft. | | | | | | |
| | | | COM | COL | 1 | 2 | 3 | 4 | 5 | 6 | 7 | 8 | 9 | 10 | L1 |
| | 831-2 | 1406 | 1546 | 1497 | 1582 | 1666 | 1750 | 1834 | 1918 | 2002 | 2086 | 2170 | 2255 | 2388 | 2691 |
| | | <i>Tilt Swivel w/ Lock / Pneumatic Seat Height Adjustment / 350 lb. Weight Capacity</i> | | | | | | | | | | | | | |
| | 831-4 | 1459 | 1605 | 1548 | 1632 | 1716 | 1800 | 1884 | 1969 | 2053 | 2137 | 2221 | 2305 | 2438 | 2741 |
| | | <i>Knee Tilt Swivel w/ Infinite Lock / Pneumatic Seat Height Adjustment / 350 lb. Weight Capacity</i> | | | | | | | | | | | | | |
|  | | | Overall: 26"w 30"d 43"-46"h | | | Arm: 25.5"-28.5"h | | | COM: 2.5 yds. | | | | | | |
| | | | Seat: 22.5"w 18.5"d 17.5"-20.5"h | | | Weight: 65 lbs. | | | COL: 45 sq.ft. | | | | | | |
| | | | COM | COL | 1 | 2 | 3 | 4 | 5 | 6 | 7 | 8 | 9 | 10 | L1 |
| | 832-2 | 1236 | 1360 | 1295 | 1358 | 1421 | 1484 | 1547 | 1611 | 1674 | 1737 | 1800 | 1863 | 1966 | 2193 |
| | | <i>Tilt Swivel w/ Lock / Pneumatic Seat Height Adjustment / 350 lb. Weight Capacity</i> | | | | | | | | | | | | | |
| | 832-4 | 1302 | 1432 | 1357 | 1420 | 1483 | 1546 | 1609 | 1672 | 1735 | 1798 | 1862 | 1925 | 2028 | 2255 |
| | | <i>Knee Tilt Swivel w/ Infinite Lock / Pneumatic Seat Height Adjustment / 350 lb. Weight Capacity</i> | | | | | | | | | | | | | |
|  | | | Overall: 26"w 29"d 38"-41"h | | | Arm: 25.5"-28.5"h | | | COM: 3.25 yds. | | | | | | |
| | | | Seat: 22.5"w 18.5"d 17.5"-20.5"h | | | Weight: 60 lbs. | | | COL: 59 sq.ft. | | | | | | |
| | | | COM | COL | 1 | 2 | 3 | 4 | 5 | 6 | 7 | 8 | 9 | 10 | L1 |
| | 841-2 | 1349 | 1483 | 1443 | 1527 | 1611 | 1696 | 1780 | 1864 | 1948 | 2032 | 2116 | 2200 | 2329 | 2632 |
| | | <i>Tilt Swivel w/ Lock / Pneumatic Seat Height Adjustment / 350 lb. Weight Capacity</i> | | | | | | | | | | | | | |
| | 841-4 | 1402 | 1542 | 1494 | 1578 | 1662 | 1746 | 1830 | 1914 | 1998 | 2083 | 2167 | 2251 | 2380 | 2683 |
| | | <i>Knee Tilt Swivel w/ Infinite Lock / Pneumatic Seat Height Adjustment / 350 lb. Weight Capacity</i> | | | | | | | | | | | | | |
|  | | | Overall: 26"w 29"d 38"-41"h | | | Arm: 25.5"-28.5"h | | | COM: 3.25 yds. | | | | | | |
| | | | Seat: 22.5"w 18.5"d 17.5"-20.5"h | | | Weight: 60 lbs. | | | COL: 59 sq.ft. | | | | | | |
| | | | COM | COL | 1 | 2 | 3 | 4 | 5 | 6 | 7 | 8 | 9 | 10 | L1 |
| | 841-5 | 1550 | 1705 | 1634 | 1718 | 1802 | 1886 | 1970 | 2055 | 2139 | 2223 | 2307 | 2391 | 2520 | 2823 |
| | | <i>Jury Base / Pneumatic Seat Height Adjustment / Self-Centering 360° Rotation / 350 lb. Weight Capacity</i> | | | | | | | | | | | | | |

DESCRIPTION:

- Upholstery Frames: Plywood & Hardwood
- Seat / Back: High Density Polyurethane Foam
- Upholstered Arms: High Density Polyurethane Foam Over Plywood & Hardwood
- Exposed Wood Arm Cap: Solid Maple / Lacquered Finish
- Open Arm: Black Urethane Molded Over A Steel Armature (All Arms Are Attached & Reinforced w/ Steel)
- Black Arched Resin Base Standard
- 10 Year Warranty

OPTIONS:

Specify Exposed Wood Finish (See Page 6)
 Base & Caster Options Available (See See Luci Guci Options Pages)

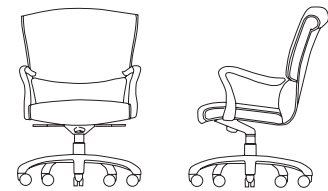
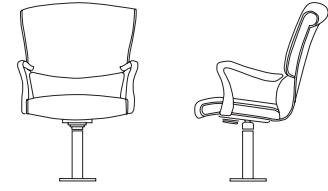
| EXECUTIVE | ITEM #: | SPECIFICATIONS GRADES LIST PRICES: | | | | | | | | | | | | | | | | | | | | | | | | | | | | | | | | | | | | | | | | | | | | | | | | | | | | | | | | | | | | | | | | | | | | | | | | | |
|---|---------|---|--------------------------|-----------------------|------|------|------|------|------|------|------|------|------|------|----|----|--------------|------|------|------|------|------|------|------|------|------|------|------|------|------|------|--|--|--|--|--|--|--|--|--|--|--|--|--|--|--|--------------|------|------|------|------|------|------|------|------|------|------|------|------|------|------|---|--|--|--|--|--|--|--|--|--|--|--|--|--|
| <p data-bbox="89 441 568 483">LOW BACK CHAIR / URETHANE OPEN ARM</p>  | | Overall: 26"w 29"d 38"-41"h | Arm: 25.5"-28.5"h | COM: 2.5 yds. | | | | | | | | | | | | | | | | | | | | | | | | | | | | | | | | | | | | | | | | | | | | | | | | | | | | | | | | | | | | | | | | | | | | | | | |
| | | Seat: 22.5"w 18.5"d 17.5"-20.5"h | Weight: 60 lbs. | COL: 45 sq.ft. | | | | | | | | | | | | | | | | | | | | | | | | | | | | | | | | | | | | | | | | | | | | | | | | | | | | | | | | | | | | | | | | | | | | | | | |
| | | <table border="1"> <thead> <tr> <th>COM</th> <th>COL</th> <th>1</th> <th>2</th> <th>3</th> <th>4</th> <th>5</th> <th>6</th> <th>7</th> <th>8</th> <th>9</th> <th>10</th> <th>L1</th> <th>L2</th> </tr> </thead> <tbody> <tr> <td data-bbox="584 567 617 609">842-2</td> <td>1194</td> <td>1314</td> <td>1255</td> <td>1318</td> <td>1381</td> <td>1444</td> <td>1508</td> <td>1571</td> <td>1634</td> <td>1697</td> <td>1760</td> <td>1823</td> <td>1923</td> <td>2150</td> </tr> <tr> <td colspan="15" data-bbox="584 609 1542 651"><i>Tilt Swivel w/ Lock / Pneumatic Seat Height Adjustment / 350 lb. Weight Capacity</i></td> </tr> <tr> <td data-bbox="584 651 617 693">842-4</td> <td>1253</td> <td>1379</td> <td>1311</td> <td>1374</td> <td>1437</td> <td>1501</td> <td>1564</td> <td>1627</td> <td>1690</td> <td>1753</td> <td>1816</td> <td>1879</td> <td>1979</td> <td>2206</td> </tr> <tr> <td colspan="15" data-bbox="584 693 1542 735"><i>Knee Tilt Swivel w/ Infinite Lock / Pneumatic Seat Height Adjustment / 350 lb. Weight Capacity</i></td> </tr> </tbody> </table> | COM | COL | 1 | 2 | 3 | 4 | 5 | 6 | 7 | 8 | 9 | 10 | L1 | L2 | 842-2 | 1194 | 1314 | 1255 | 1318 | 1381 | 1444 | 1508 | 1571 | 1634 | 1697 | 1760 | 1823 | 1923 | 2150 | <i>Tilt Swivel w/ Lock / Pneumatic Seat Height Adjustment / 350 lb. Weight Capacity</i> | | | | | | | | | | | | | | | 842-4 | 1253 | 1379 | 1311 | 1374 | 1437 | 1501 | 1564 | 1627 | 1690 | 1753 | 1816 | 1879 | 1979 | 2206 | <i>Knee Tilt Swivel w/ Infinite Lock / Pneumatic Seat Height Adjustment / 350 lb. Weight Capacity</i> | | | | | | | | | | | | | |
| COM | COL | 1 | 2 | 3 | 4 | 5 | 6 | 7 | 8 | 9 | 10 | L1 | L2 | | | | | | | | | | | | | | | | | | | | | | | | | | | | | | | | | | | | | | | | | | | | | | | | | | | | | | | | | | | | | | |
| 842-2 | 1194 | 1314 | 1255 | 1318 | 1381 | 1444 | 1508 | 1571 | 1634 | 1697 | 1760 | 1823 | 1923 | 2150 | | | | | | | | | | | | | | | | | | | | | | | | | | | | | | | | | | | | | | | | | | | | | | | | | | | | | | | | | | | | | |
| <i>Tilt Swivel w/ Lock / Pneumatic Seat Height Adjustment / 350 lb. Weight Capacity</i> | | | | | | | | | | | | | | | | | | | | | | | | | | | | | | | | | | | | | | | | | | | | | | | | | | | | | | | | | | | | | | | | | | | | | | | | | | | |
| 842-4 | 1253 | 1379 | 1311 | 1374 | 1437 | 1501 | 1564 | 1627 | 1690 | 1753 | 1816 | 1879 | 1979 | 2206 | | | | | | | | | | | | | | | | | | | | | | | | | | | | | | | | | | | | | | | | | | | | | | | | | | | | | | | | | | | | | |
| <i>Knee Tilt Swivel w/ Infinite Lock / Pneumatic Seat Height Adjustment / 350 lb. Weight Capacity</i> | | | | | | | | | | | | | | | | | | | | | | | | | | | | | | | | | | | | | | | | | | | | | | | | | | | | | | | | | | | | | | | | | | | | | | | | | | | |
| <p data-bbox="89 840 568 882">LOW BACK JURY CHAIR / URETHANE OPEN ARM</p>  | | Overall: 26"w 29"d 38"-41"h | Arm: 25.5"-28.5"h | COM: 2.5 yds. | | | | | | | | | | | | | | | | | | | | | | | | | | | | | | | | | | | | | | | | | | | | | | | | | | | | | | | | | | | | | | | | | | | | | | | |
| | | Seat: 22.5"w 18.5"d 17.5"-20.5"h | Weight: 60 lbs. | COL: 45 sq.ft. | | | | | | | | | | | | | | | | | | | | | | | | | | | | | | | | | | | | | | | | | | | | | | | | | | | | | | | | | | | | | | | | | | | | | | | |
| | | <table border="1"> <thead> <tr> <th>COM</th> <th>COL</th> <th>1</th> <th>2</th> <th>3</th> <th>4</th> <th>5</th> <th>6</th> <th>7</th> <th>8</th> <th>9</th> <th>10</th> <th>L1</th> <th>L2</th> </tr> </thead> <tbody> <tr> <td data-bbox="584 966 617 1008">842-5</td> <td>1396</td> <td>1535</td> <td>1446</td> <td>1509</td> <td>1572</td> <td>1635</td> <td>1698</td> <td>1761</td> <td>1824</td> <td>1887</td> <td>1951</td> <td>2014</td> <td>2113</td> <td>2340</td> </tr> <tr> <td colspan="15" data-bbox="584 1008 1542 1050"><i>Jury Base / Pneumatic Seat Height Adjustment / Self-Centering 360° Rotation / 350 lb. Weight Capacity</i></td> </tr> </tbody> </table> | COM | COL | 1 | 2 | 3 | 4 | 5 | 6 | 7 | 8 | 9 | 10 | L1 | L2 | 842-5 | 1396 | 1535 | 1446 | 1509 | 1572 | 1635 | 1698 | 1761 | 1824 | 1887 | 1951 | 2014 | 2113 | 2340 | <i>Jury Base / Pneumatic Seat Height Adjustment / Self-Centering 360° Rotation / 350 lb. Weight Capacity</i> | | | | | | | | | | | | | | | | | | | | | | | | | | | | | | | | | | | | | | | | | | | |
| COM | COL | 1 | 2 | 3 | 4 | 5 | 6 | 7 | 8 | 9 | 10 | L1 | L2 | | | | | | | | | | | | | | | | | | | | | | | | | | | | | | | | | | | | | | | | | | | | | | | | | | | | | | | | | | | | | | |
| 842-5 | 1396 | 1535 | 1446 | 1509 | 1572 | 1635 | 1698 | 1761 | 1824 | 1887 | 1951 | 2014 | 2113 | 2340 | | | | | | | | | | | | | | | | | | | | | | | | | | | | | | | | | | | | | | | | | | | | | | | | | | | | | | | | | | | | | |
| <i>Jury Base / Pneumatic Seat Height Adjustment / Self-Centering 360° Rotation / 350 lb. Weight Capacity</i> | | | | | | | | | | | | | | | | | | | | | | | | | | | | | | | | | | | | | | | | | | | | | | | | | | | | | | | | | | | | | | | | | | | | | | | | | | | |



DESCRIPTION:

- Upholstery Frames: Plywood & Hardwood
- Seat: High Density Polyurethane Foam Over Sheet Webbing
- Back: High Density Polyurethane Foam Over Polypropylene Webbing (#854)
- Exposed Wood Arms: Solid Maple / Lacquered Finish
(All Arms Are Attached & Reinforced w/ Steel)
- 10 Year Warranty

OPTIONS:

- ST-1 Wooden Horizontal Stretchers (Guest Chairs Only).....\$97
- BR-1 Wooden Horizontal Book Rack (Guest Chairs Only).....\$218
- SGS Soft Ganging Straps\$34 Per Seat
- D800-6 Single Stacking Cart (Stacks 6 Chairs).....\$960 Each
- D800-12 Double Stacing Cart (Stacks 12 Chairs).....\$1268 Each

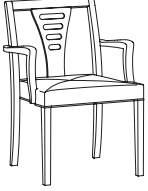
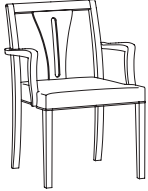
Specify Exposed Wood Finish (See Page 6)
Optional Custom Engraving Back Designs Available (Contact Factory)

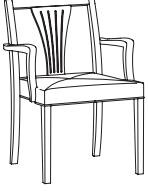
| GUEST / STACKING | | ITEM #: | SPECIFICATIONS GRADES LIST PRICES: | | | | | | | | | | | | | |
|---|--|--------------|--|------------|----------|------------------------|----------|----------|-----------------------|----------|----------|----------|----------|-----------|-----------|-----------|
| STACKING OPEN ARM SIDE CHAIR / HORIZONTAL DESIGN SLAT BACK | | | <i>Overall: 21.5"w 23"d 31.5"h</i> | | | <i>Arm: 25.5"h</i> | | | <i>COM: 1.25 yds.</i> | | | | | | | |
| | | | <i>Seat: 19"w 18.5"d 18"h</i> | | | <i>Weight: 25 lbs.</i> | | | <i>COL: 20 sq.ft.</i> | | | | | | | |
|   | | | COM | COL | 1 | 2 | 3 | 4 | 5 | 6 | 7 | 8 | 9 | 10 | L1 | L2 |
| 855-P | | 855-P | 795 | 874 | 807 | 835 | 864 | 892 | 920 | 948 | 976 | 1004 | 1032 | 1060 | 1063 | 1153 |
| | | | <i>Fully Upholstered Plain Seat / 350 lb. Weight Capacity</i> | | | | | | | | | | | | | |
| 855-T | | 855-T | 812 | 893 | 824 | 852 | 880 | 908 | 936 | 964 | 992 | 1020 | 1048 | 1076 | 1083 | 1172 |
| | | | <i>Fully Upholstered Seat / Diagonally Sewn Buttonless Tufting / 350 lb. Weight Capacity</i> | | | | | | | | | | | | | |
| STACKING OPEN ARM SIDE CHAIR / VERTICAL DESIGN SLAT BACK | | | <i>Overall: 21.5"w 23"d 31.5"h</i> | | | <i>Arm: 25.5"h</i> | | | <i>COM: 1.25 yds.</i> | | | | | | | |
| | | | <i>Seat: 19"w 18.5"d 18"h</i> | | | <i>Weight: 25 lbs.</i> | | | <i>COL: 20 sq.ft.</i> | | | | | | | |
|   | | | COM | COL | 1 | 2 | 3 | 4 | 5 | 6 | 7 | 8 | 9 | 10 | L1 | L2 |
| 856-P | | 856-P | 795 | 874 | 807 | 835 | 864 | 892 | 920 | 948 | 976 | 1004 | 1032 | 1060 | 1063 | 1153 |
| | | | <i>Fully Upholstered Plain Seat / 350 lb. Weight Capacity</i> | | | | | | | | | | | | | |
| 856-T | | 856-T | 812 | 893 | 824 | 852 | 880 | 908 | 936 | 964 | 992 | 1020 | 1048 | 1076 | 1083 | 1172 |
| | | | <i>Fully Upholstered Seat / Diagonally Sewn Buttonless Tufting / 350 lb. Weight Capacity</i> | | | | | | | | | | | | | |
| STACKING OPEN ARM SIDE CHAIR / WHEAT DESIGN SLAT BACK | | | <i>Overall: 21.5"w 23"d 31.5"h</i> | | | <i>Arm: 25.5"h</i> | | | <i>COM: 1.25 yds.</i> | | | | | | | |
| | | | <i>Seat: 19"w 18.5"d 18"h</i> | | | <i>Weight: 25 lbs.</i> | | | <i>COL: 20 sq.ft.</i> | | | | | | | |
|   | | | COM | COL | 1 | 2 | 3 | 4 | 5 | 6 | 7 | 8 | 9 | 10 | L1 | L2 |
| 857-P | | 857-P | 795 | 874 | 807 | 835 | 864 | 892 | 920 | 948 | 976 | 1004 | 1032 | 1060 | 1063 | 1153 |
| | | | <i>Fully Upholstered Plain Seat</i> | | | | | | | | | | | | | |
| 857-T | | 857-T | 812 | 893 | 824 | 852 | 880 | 908 | 936 | 964 | 992 | 1020 | 1048 | 1076 | 1083 | 1172 |
| | | | <i>Fully Upholstered Seat / Diagonally Sewn Buttonless Tufting / 350 lb. Weight Capacity</i> | | | | | | | | | | | | | |





DESCRIPTION:

- Upholstery Frames: Plywood & Hardwood
- Seat: High Density Polyurethane Foam Over Sheet Webbing
- Back: High Density Polyurethane Foam Over Polypropylene Webbing (#859)
- Exposed Wood Arms: Solid Maple / Lacquered Finish
(All Arms Are Attached & Reinforced w/ Steel)
- 10 Year Warranty



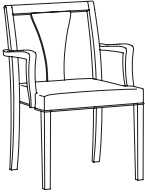

OPTIONS:

- SGS Soft Ganging Straps\$34 Per Seat
- D800-6 Single Stacking Cart (Stacks 6 Chairs).....\$960 Each
- D800-12 Double Stacing Cart (Stacks 12 Chairs).....\$1268 Each

Specify Exposed Wood Finish (See Page 6)
Optional Custom Engraving Back Designs Available (Contact Factory)

| GUEST / STACKING | | ITEM #: | SPECIFICATIONS GRADES LIST PRICES: | | | | | | | | | | | | | |
|---|--|--------------|--|------------|----------|------------------------|----------|----------|-----------------------|----------|----------|----------|----------|-----------|-----------|-----------|
| STACKING OPEN ARM SIDE CHAIR / UPHOLSTERED SLAT BACK | | | <i>Overall: 21.5"w 23"d 31.5"h</i> | | | <i>Arm: 25.5"h</i> | | | <i>COM: 1.5 yds.</i> | | | | | | | |
| | | | <i>Seat: 19"w 18.5"d 18"h</i> | | | <i>Weight: 25 lbs.</i> | | | <i>COL: 24 sq.ft.</i> | | | | | | | |
|  858-P  858-T | | | COM | COL | 1 | 2 | 3 | 4 | 5 | 6 | 7 | 8 | 9 | 10 | L1 | L2 |
| | | 858-P | 821 | 903 | 847 | 882 | 917 | 952 | 987 | 1022 | 1057 | 1092 | 1127 | 1162 | 1164 | 1276 |
| | | | <i>Fully Upholstered Plain Seat / 350 lb. Weight Capacity</i> | | | | | | | | | | | | | |
| | | 858-T | 835 | 918 | 859 | 894 | 929 | 964 | 999 | 1034 | 1069 | 1104 | 1139 | 1175 | 1179 | 1291 |
| | | | <i>Fully Upholstered Seat / Diagonally Sewn Buttonless Tufting / 350 lb. Weight Capacity</i> | | | | | | | | | | | | | |
| STACKING OPEN ARM SIDE CHAIR / FULLY UPHOLSTERED BACK | | | <i>Overall: 21.5"w 23"d 31.5"h</i> | | | <i>Arm: 25.5"h</i> | | | <i>COM: 1.75 yds.</i> | | | | | | | |
| | | | <i>Seat: 19"w 18.5"d 18"h</i> | | | <i>Weight: 25 lbs.</i> | | | <i>COL: 28 sq.ft.</i> | | | | | | | |
|  859-P  859-T | | | COM | COL | 1 | 2 | 3 | 4 | 5 | 6 | 7 | 8 | 9 | 10 | L1 | L2 |
| | | 859-P | 759 | 835 | 802 | 844 | 886 | 928 | 970 | 1012 | 1054 | 1096 | 1138 | 1180 | 1236 | 1387 |
| | | | <i>Fully Upholstered Plain Seat / 350 lb. Weight Capacity</i> | | | | | | | | | | | | | |
| | | 859-T | 777 | 854 | 818 | 860 | 902 | 944 | 987 | 1029 | 1071 | 1113 | 1155 | 1197 | 1255 | 1407 |
| | | | <i>Fully Upholstered Seat / Diagonally Sewn Buttonless Tufting / 350 lb. Weight Capacity</i> | | | | | | | | | | | | | |

| BASES | OPTION #: SPECIFICATIONS LIST PRICES AVAILABILITY: | | | | | | | | |
|--|--|-----------------------------------|------------------------|--|------------------|---|-----------------|-----------------------|------------------|
| <p>TRANSITIONAL WOOD BASE</p>  <p>TWB</p> | <p>Overall: 25"w 25"d 5.5"h</p> <hr/> <p>\$237 Solid Hardwood Cap, Steel Reinforced 5 Prong Base With 55mm Black Dual Wheel Casters.</p> <p>OPTIONS:</p> <table border="0"> <tr> <td>C1 Carpet Caster - 2" Metal Balls</td> <td>\$200 (Set Of 5)</td> </tr> <tr> <td>C2 Antique Bronze Hooded Caster - 2" Rubber Ball</td> <td>\$152 (Set Of 5)</td> </tr> <tr> <td>C3 Brass Hooded Black Caster - 2" Dual Wheels</td> <td>\$95 (Set Of 5)</td> </tr> </table> <p>Available: <i>Luci Guci Executive Seating</i></p> | C1 Carpet Caster - 2" Metal Balls | \$200 (Set Of 5) | C2 Antique Bronze Hooded Caster - 2" Rubber Ball | \$152 (Set Of 5) | C3 Brass Hooded Black Caster - 2" Dual Wheels | \$95 (Set Of 5) | | |
| C1 Carpet Caster - 2" Metal Balls | \$200 (Set Of 5) | | | | | | | | |
| C2 Antique Bronze Hooded Caster - 2" Rubber Ball | \$152 (Set Of 5) | | | | | | | | |
| C3 Brass Hooded Black Caster - 2" Dual Wheels | \$95 (Set Of 5) | | | | | | | | |
| <p>CLASSIC WOOD BASE</p>  <p>CWB</p> | <p>Overall: 28"w 28"d 5"h</p> <hr/> <p>\$237 Solid Hardwood Cap, Steel Reinforced 5 Prong Base With 55mm Black Dual Wheel Casters.</p> <p>OPTIONS:</p> <table border="0"> <tr> <td>C1 Carpet Caster - 2" Metal Balls</td> <td>\$200 (Set Of 5)</td> </tr> <tr> <td>C2 Antique Bronze Hooded Caster - 2" Rubber Ball</td> <td>\$152 (Set Of 5)</td> </tr> <tr> <td>C3 Brass Hooded Black Caster - 2" Dual Wheels</td> <td>\$95 (Set Of 5)</td> </tr> <tr> <td>SP Brass Scuff Plates</td> <td>\$121 (Set Of 5)</td> </tr> </table> <p>Available: <i>Luci Guci Executive Seating</i></p> | C1 Carpet Caster - 2" Metal Balls | \$200 (Set Of 5) | C2 Antique Bronze Hooded Caster - 2" Rubber Ball | \$152 (Set Of 5) | C3 Brass Hooded Black Caster - 2" Dual Wheels | \$95 (Set Of 5) | SP Brass Scuff Plates | \$121 (Set Of 5) |
| C1 Carpet Caster - 2" Metal Balls | \$200 (Set Of 5) | | | | | | | | |
| C2 Antique Bronze Hooded Caster - 2" Rubber Ball | \$152 (Set Of 5) | | | | | | | | |
| C3 Brass Hooded Black Caster - 2" Dual Wheels | \$95 (Set Of 5) | | | | | | | | |
| SP Brass Scuff Plates | \$121 (Set Of 5) | | | | | | | | |
| <p>ARCHED RESIN BASE</p>  <p>ARB</p> | <p>Overall: 27"w 27"d 6.25"h</p> <hr/> <p>Standard - No Charge Black Reinforced Nylon 5 Prong Base With 55mm Black Dual Wheel Casters.</p> <p>OPTIONS:</p> <table border="0"> <tr> <td>C4 Black Sculptured Glides</td> <td>No Upcharge (Set Of 5)</td> </tr> </table> <p>Available: <i>Luci Guci Executive Seating</i></p> | C4 Black Sculptured Glides | No Upcharge (Set Of 5) | | | | | | |
| C4 Black Sculptured Glides | No Upcharge (Set Of 5) | | | | | | | | |
| <p>POLISHED ALUMINUM BASE</p>  <p>PAB</p> | <p>Overall: 26"w 26"d 8"h</p> <hr/> <p>\$120 Polished Aluminum 5 Prong Base With 55mm Black Dual Wheel Casters</p> <p>OPTIONS:</p> <table border="0"> <tr> <td>C4 Black Sculptured Glides</td> <td>No Upcharge (Set Of 5)</td> </tr> <tr> <td>C5 Polished Aluminum Hooded Casters</td> <td>\$105 (Set Of 5)</td> </tr> </table> <p>Available: <i>Luci Guci Executive Seating</i></p> | C4 Black Sculptured Glides | No Upcharge (Set Of 5) | C5 Polished Aluminum Hooded Casters | \$105 (Set Of 5) | | | | |
| C4 Black Sculptured Glides | No Upcharge (Set Of 5) | | | | | | | | |
| C5 Polished Aluminum Hooded Casters | \$105 (Set Of 5) | | | | | | | | |

| BASES / CASTERS / SCUFF PLATES | OPTION #: | SPECIFICATIONS LIST PRICES AVAILABILITY: |
|--|---|--|
| <p>HIGH PROFILE BASE</p>  | <p>HPB</p> <p>No Charge <i>Black Reinforced Nylon 5 Prong Base With 55mm Black Dual Wheel Casters</i></p> <p>Available: Luci Guci Executive Seating</p> | |
| <p>JURY BASE</p>  | <p>JRB</p> <p>Overall: 8.5" Diameter 3.75"h</p> <p>\$200 <i>360° Rotation, Self Centering With Pneumatic Height Adjustment</i></p> <p>OPTIONS: No Rotation</p> <p>Available: Luci Guci Executive Seating</p> | |
| <p>CASTERS</p>  <p>(C1) Carpet Caster - 2" Metal Balls</p> <p>(C2) Antique Bronze Hooded Caster - 2" Rubber Ball</p> <p>(C3) Brass Hooded Black Caster - 2" Dual Wheels</p> <p>(C4) Black Sculptured Glide - 2" Flat Bottom Glide</p> <p>(C5) Polished Aluminum Caster - 2" Dual Wheels</p> | <p>Overall: 2"h</p> <p>C1 \$200 (Set Of 5) <i>Carpet Caster - 2" Metal Balls - Antique Windsor (Additional Finishes Available)</i></p> <p>C2 \$152 (Set Of 5) <i>Antique Bronze Hooded Caster - 2" Rubber Ball (Additional Finishes Available)</i></p> <p>C3 \$95 (Set Of 5) <i>Brass Hooded Black Caster - 2" Dual Wheels (Additional Finishes Available)</i></p> <p>C4 No Charge (Set Of 5) <i>Black Sculptured Glide - 2" Flat Bottom Glide</i></p> <p>C5 \$105 (Set Of 5) <i>Polished Aluminum Hooded Caster - 2" Dual Wheels</i></p> <p>Available: Luci Guci Executive Seating</p> | |
| <p>SCUFF PLATES</p>  | <p>SP</p> <p>Overall: 1"w 4"d</p> <p>\$121 (Set Of 5) <i>(Specify Brass Or Pewter)</i></p> <p>Available: Classic Base Only</p> | |

| GANGING / ENGRAVING | OPTION #: | SPECIFICATIONS LIST PRICES AVAILABILITY: |
|---|--|--|
| <p>SOFT GANGING</p>  | <p>SGS</p> <p>\$34 Per Seat <i>Black Velcro Soft Ganging Straps</i></p> <p><i>Available: Luci Guci Stacking Chairs</i></p> | |
| <p>CUSTOM ENGRAVING BACK DESIGNS</p>  | <p>CEB</p> <p>CALL FOR PRICING <i>Custom Engraving Back Designs</i></p> <p><i>Available: Luci Guci Guest / Stacking Chairs</i></p> | |

| STRETCHERS / BOOK RACK / STACKING / COVERS | OPTION #: | SPECIFICATIONS LIST PRICES AVAILABILITY: |
|--|---|--|
| <p>STRETCHERS</p>  | <p>ST-1</p> <p><i>Overall: 23"w 25"d 1"h</i></p> <p>\$97 <i>Wooden Horizontal Stretchers</i></p> <p><i>Available: Luci Guci Guest Chairs</i></p> | |
| <p>BOOK RACK</p>  | <p>BR-1</p> <p><i>Overall: 23"w 25"d 1"h</i></p> <p>\$218 <i>Wooden Horizontal Book Rack</i></p> <p><i>Available: Luci Guci Guest Chairs</i></p> | |
| <p>STACKING CARTS</p>  <p>Single Stacking</p> <p>Double Stacking</p> | <p><i>Overall: 26"w 37"d 12"h (Single Stacking Cart) / 37"w 50"d 12"h (Double Stacking Cart)</i></p> <p>D800-6</p> <p>\$960 <i>Single Stacking Cart (Stacks 6 Chairs)</i></p> <p>D800-12</p> <p>\$1268 <i>Double Stacking Cart (Stacks 12 Chairs)</i></p> <p><i>Available: Luci Guci Stacking Chairs</i></p> | |
| <p>CONTRASTING COVERS</p>  | <p><i>Overall: n/a</i></p> <p>CC</p> <p>\$129</p> <p><i>NOTE: If Two Or More Upholsteries Or Leathers Are Used On Any Piece Of Furniture, Then A Contrast Charge Will Apply Per Order. When Using Trinity Upholstery, The Higher Priced Upholstery Grade Will Be Used In Pricing, Unless It's Trinity Leather With Fabric Contrast Welt, Or COM With Trinity Contrast Welt, Then Contact Customer Service For Pricing.</i></p> <p><i>Available: Luci Guci Collection</i></p> | |

Quads

LOUNGE SEATING

Effective: March 1, 2025

T R I N I T Y

Date:

Page:

Modification:

Description:

DESCRIPTION:

- Upholstery Frames: Hardwood & Plywood
- Seat: High Density Polyurethane Foam Over Sheet Webbing
- Back: High Density Polyurethane Foam Over Sinuous Wire Springs
- Loose Cushions: High Density Polydacron
- Leather / Vinyl Cushions Are Not Reversible
- Integral Exposed Wood Legs: Solid Maple
- 10 Year Warranty

OPTIONS:

- ARL Brushed Aluminum Round Legs (Set Of 4).....\$353
- PM1 Power/Data Module (1-Power / 1-USB 2 Port Simplex Charger)\$859
(Additional Power/Data Modules Available - See Quads Options)

Feather Down & Polyester Pillows Available (See Page 5)
Specify Exposed Wood Finish (See Page 6)
Tablet Arm / Cup Holder Options (See Quads Options Pages)

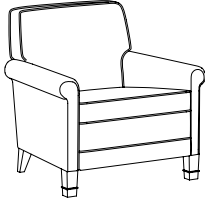
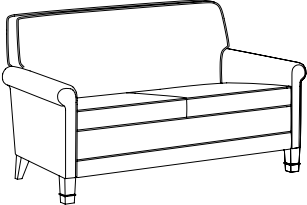
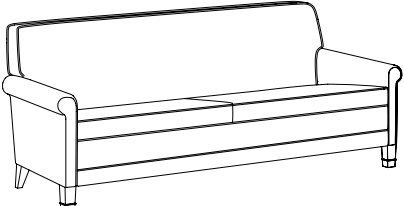
| Q1 LOUNGE | | ITEM #: | SPECIFICATIONS GRADES LIST PRICES: | | | | | | | | | | | | | |
|--|------------------|--|--|------------|----------|-------------------------|----------|----------|---|----------|----------|----------|----------|-----------|-----------|-----------|
|  | LOUNGE CHAIR | | Overall: 32"w 31"d 33"h | | | Arm: 23"h | | | COM: 5 yds. (861-P) / 5.25 yds. (861-C) | | | | | | | |
| | | | Seat: 22.5"w 20.5"d 18"h | | | Weight: 76 lbs. | | | COL: 90 sq.ft. (861-P) / 95 sq.ft. (861-C) | | | | | | | |
| | | | COM | COL | 1 | 2 | 3 | 4 | 5 | 6 | 7 | 8 | 9 | 10 | L1 | L2 |
| | 861-P | 1541 | 1696 | 1724 | 1857 | 1990 | 2123 | 2256 | 2390 | 2523 | 2656 | 2789 | 2922 | 3095 | 3575 | |
| | | <i>Tight Seat / Tight Back / 500 lb. Weight Capacity</i> | | | | | | | | | | | | | | |
| | 861-C | 1572 | 1729 | 1767 | 1907 | 2047 | 2187 | 2327 | 2468 | 2608 | 2748 | 2888 | 3028 | 3207 | 3712 | |
| | | <i>Reversible Loose Seat Cushion / Tight Back / 500 lb. Weight Capacity</i> | | | | | | | | | | | | | | |
|  | TWO PLACE SOFA | | Overall: 55.5"w 31"d 33"h | | | Arm: 23"h | | | COM: 7 yds. (862-P) / 7.5 yds. (862-C) | | | | | | | |
| | | | Seat: 46"w 20.5"d 18"h | | | Weight: 100 lbs. | | | COL: 126 sq.ft. (862-P) / 135 sq.ft. (862-C) | | | | | | | |
| | | | COM | COL | 1 | 2 | 3 | 4 | 5 | 6 | 7 | 8 | 9 | 10 | L1 | L2 |
| | 862-P | 2114 | 2326 | 2377 | 2567 | 2756 | 2945 | 3135 | 3324 | 3513 | 3702 | 3892 | 4081 | 4311 | 4992 | |
| | | <i>Tight Seat / Tight Back / 750 lb. Weight Capacity</i> | | | | | | | | | | | | | | |
| | 862-C | 2065 | 2271 | 2359 | 2562 | 2765 | 2969 | 3172 | 3375 | 3578 | 3782 | 3985 | 4188 | 4434 | 5166 | |
| | | <i>Reversible Loose Seat Cushion / Tight Back / 750 lb. Weight Capacity</i> | | | | | | | | | | | | | | |
|  | THREE PLACE SOFA | | Overall: 79"w 31"d 33"h | | | Arm: 23"h | | | COM: 8.75 yds. (863-P) / 10 yds. (863-C) | | | | | | | |
| | | | Seat: 69.5"w 20.5"d 18"h | | | Weight: 135 lbs. | | | COL: 158 sq.ft. (863-P) / 180 sq.ft. (863-C) | | | | | | | |
| | | | COM | COL | 1 | 2 | 3 | 4 | 5 | 6 | 7 | 8 | 9 | 10 | L1 | L2 |
| | 863-P | 2574 | 2831 | 2910 | 3149 | 3387 | 3625 | 3864 | 4102 | 4340 | 4579 | 4817 | 5055 | 5336 | 6194 | |
| | | <i>Tight Seat / Tight Back / 1000 lb. Weight Capacity</i> | | | | | | | | | | | | | | |
| | 863-C | 2537 | 2790 | 2945 | 3218 | 3492 | 3765 | 4038 | 4312 | 4585 | 4859 | 5132 | 5405 | 5718 | 6703 | |
| | | <i>Reversible Loose Seat Cushion / Tight Back / 1000 lb. Weight Capacity</i> | | | | | | | | | | | | | | |

DESCRIPTION:

- Upholstery Frames: Hardwood & Plywood
- Seat: High Density Polyurethane Foam Over Sheet Webbing
- Back: High Density Polyurethane Foam Over Sinuous Wire Springs
- Loose Cushions: High Density Polydacron
- Leather / Vinyl Cushions Are Not Reversible
- Integral Exposed Wood Legs: Solid Maple
- 10 Year Warranty

OPTIONS:

- ARL Brushed Aluminum Round Legs (Set Of 4).....\$353
- PM1 Power/Data Module (1-Power / 1-USB 2 Port Simplex Charger)\$859
(Additional Power/Data Modules Available - See Quads Options)

Feather Down & Polyester Pillows Available (See Page 5)
Specify Exposed Wood Finish (See Page 6)
Tablet Arm / Cup Holder Options (See Quads Options Pages)

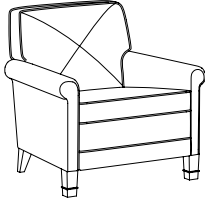
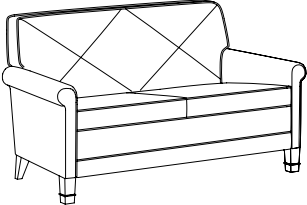
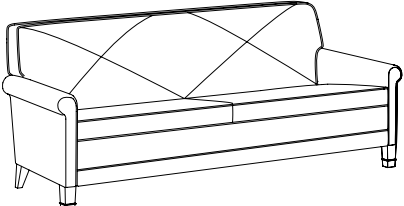
| Q1 LOUNGE | | ITEM #: | SPECIFICATIONS GRADES LIST PRICES: | | | | | | | | | | | | | |
|--|-------------------------|--|--|------------|----------|-------------------------|----------|----------|---|----------|----------|----------|----------|-----------|-----------|-----------|
|  | LOUNGE CHAIR | | Overall: 32"w 31"d 33"h | | | Arm: 23"h | | | COM: 5 yds. (864-P) / 5.25 yds. (864-C) | | | | | | | |
| | | | Seat: 22.5"w 20.5"d 18"h | | | Weight: 75 lbs. | | | COL: 90 sq.ft. (864-P) / 95 sq.ft. (864-C) | | | | | | | |
| | | | COM | COL | 1 | 2 | 3 | 4 | 5 | 6 | 7 | 8 | 9 | 10 | L1 | L2 |
| | 864-P | 1562 | 1719 | 1743 | 1877 | 2010 | 2143 | 2276 | 2409 | 2543 | 2676 | 2809 | 2942 | 3118 | 3597 | |
| | | <i>Tight Seat / Diagonally Sewn Buttonless Tufted Back / 500 lb. Weight Capacity</i> | | | | | | | | | | | | | | |
| | 864-C | 1593 | 1752 | 1787 | 1927 | 2067 | 2207 | 2347 | 2488 | 2628 | 2768 | 2908 | 3048 | 3230 | 3735 | |
| | | <i>Reversible Loose Seat Cushion / Diagonally Sewn Buttonless Tufted Back / 500 lb. Weight Capacity</i> | | | | | | | | | | | | | | |
|  | TWO PLACE SOFA | | Overall: 55.5"w 31"d 33"h | | | Arm: 23"h | | | COM: 7.25 yds. (865-P) / 8.25 yds. (865-C) | | | | | | | |
| | | | Seat: 46"w 20.5"d 18"h | | | Weight: 100 lbs. | | | COL: 131 sq.ft. (865-P) / 149 sq.ft. (865-C) | | | | | | | |
| | | | COM | COL | 1 | 2 | 3 | 4 | 5 | 6 | 7 | 8 | 9 | 10 | L1 | L2 |
| | 865-P | 2156 | 2372 | 2431 | 2627 | 2824 | 3020 | 3216 | 3412 | 3609 | 3805 | 4001 | 4198 | 4438 | 5145 | |
| | | <i>Tight Seat / Diagonally Sewn Buttonless Tufted Back / 750 lb. Weight Capacity</i> | | | | | | | | | | | | | | |
| | 865-C | 2106 | 2317 | 2440 | 2664 | 2889 | 3113 | 3337 | 3562 | 3786 | 4010 | 4235 | 4459 | 4724 | 5532 | |
| | | <i>Reversible Loose Seat Cushion / Diagonally Sewn Buttonless Tufted Back / 750 lb. Weight Capacity</i> | | | | | | | | | | | | | | |
|  | THREE PLACE SOFA | | Overall: 79"w 31"d 33"h | | | Arm: 23"h | | | COM: 8.75 yds. (866-P) / 9.5 yds. (866-C) | | | | | | | |
| | | | Seat: 69.5"w 20.5"d 18"h | | | Weight: 135 lbs. | | | COL: 158 sq.ft. (866-P) / 171 sq.ft. (866-C) | | | | | | | |
| | | | COM | COL | 1 | 2 | 3 | 4 | 5 | 6 | 7 | 8 | 9 | 10 | L1 | L2 |
| | 866-P | 2616 | 2877 | 2950 | 3188 | 3427 | 3665 | 3903 | 4142 | 4380 | 4618 | 4857 | 5095 | 5381 | 6239 | |
| | | <i>Tight Seat / Diagonally Sewn Buttonless Tufted Back / 1000 lb. Weight Capacity</i> | | | | | | | | | | | | | | |
| | 866-C | 2567 | 2824 | 2946 | 3205 | 3464 | 3724 | 3983 | 4242 | 4502 | 4761 | 5021 | 5280 | 5588 | 6521 | |
| | | <i>Reversible Loose Seat Cushion / Diagonally Sewn Buttonless Tufted Back / 1000 lb. Weight Capacity</i> | | | | | | | | | | | | | | |

DESCRIPTION:

- Upholstery Frames: Hardwood & Plywood
- Seat: High Density Polyurethane Foam Over Sheet Webbing
- Back: High Density Polyurethane Foam Over Sinuous Wire Springs
- Loose Cushions: High Density Polydacron
- Leather / Vinyl Cushions Are Not Reversible
- Integral Exposed Wood Legs: Solid Maple
- 10 Year Warranty

OPTIONS:

- ARL Brushed Aluminum Round Legs (Set Of 4).....\$353
- PM1 Power/Data Module (1-Power / 1-USB 2 Port Simplex Charger)\$859
(Additional Power/Data Modules Available - See Quads Options)

Feather Down & Polyester Pillows Available (See Page 5)
Specify Exposed Wood Finish (See Page 6)
Tablet Arm / Cup Holder Options (See Quads Options Pages)

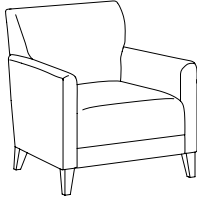
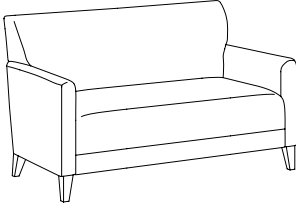
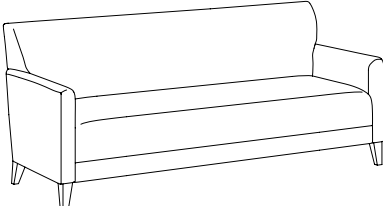
| Q2 LOUNGE | | ITEM #: | SPECIFICATIONS GRADES LIST PRICES: | | | | | | | | | | | | | |
|--|------------------|--|--|------------|----------|-------------------------|----------|----------|---|----------|----------|----------|----------|-----------|-----------|-----------|
|  | LOUNGE CHAIR | | Overall: 29"w 31"d 33"h | | | Arm: 22.5"h | | | COM: 5 yds. (871-P) / 5 yds. (871-C) | | | | | | | |
| | | | Seat: 22"w 21"d 17"h | | | Weight: 75 lbs. | | | COL: 90 sq.ft. (871-P) / 90 sq.ft. (871-C) | | | | | | | |
| | | | COM | COL | 1 | 2 | 3 | 4 | 5 | 6 | 7 | 8 | 9 | 10 | L1 | L2 |
| | 871-P | 1416 | 1557 | 1605 | 1738 | 1871 | 2005 | 2138 | 2271 | 2404 | 2537 | 2670 | 2804 | 2973 | 3452 | |
| | | <i>Tight Seat / Tight Back / 500 lb. Weight Capacity</i> | | | | | | | | | | | | | | |
| | 871-C | 1432 | 1575 | 1620 | 1753 | 1886 | 2020 | 2153 | 2286 | 2419 | 2552 | 2686 | 2819 | 2990 | 3469 | |
| | | <i>Reversible Loose Seat Cushion / Tight Back / 500 lb. Weight Capacity</i> | | | | | | | | | | | | | | |
|  | TWO PLACE SOFA | | Overall: 53"w 31"d 33"h | | | Arm: 22.5"h | | | COM: 6.75 yds. (872-P) / 7 yds. (872-C) | | | | | | | |
| | | | Seat: 46"w 21"d 17"h | | | Weight: 100 lbs. | | | COL: 122 sq.ft. (872-P) / 126 sq.ft. (872-C) | | | | | | | |
| | | | COM | COL | 1 | 2 | 3 | 4 | 5 | 6 | 7 | 8 | 9 | 10 | L1 | L2 |
| | 872-P | 1995 | 2194 | 2250 | 2433 | 2615 | 2797 | 2979 | 3162 | 3344 | 3526 | 3708 | 3891 | 4112 | 4768 | |
| | | <i>Tight Seat / Tight Back / 750 lb. Weight Capacity</i> | | | | | | | | | | | | | | |
| | 872-C | 2016 | 2218 | 2285 | 2474 | 2663 | 2853 | 3042 | 3231 | 3420 | 3610 | 3799 | 3988 | 4221 | 4902 | |
| | | <i>Reversible Loose Seat Cushion / Tight Back / 750 lb. Weight Capacity</i> | | | | | | | | | | | | | | |
|  | THREE PLACE SOFA | | Overall: 76.5"w 31"d 33"h | | | Arm: 22.5"h | | | COM: 9.25 yds. (873-P) / 9.25 yds. (873-C) | | | | | | | |
| | | | Seat: 69.5"w 21"d 17"h | | | Weight: 130 lbs. | | | COL: 167 sq.ft. (873-P) / 167 sq.ft. (873-C) | | | | | | | |
| | | | COM | COL | 1 | 2 | 3 | 4 | 5 | 6 | 7 | 8 | 9 | 10 | L1 | L2 |
| | 873-P | 2472 | 2719 | 2842 | 3094 | 3347 | 3599 | 3851 | 4104 | 4356 | 4608 | 4861 | 5113 | 5400 | 6309 | |
| | | <i>Tight Seat / Tight Back / 1000 lb. Weight Capacity</i> | | | | | | | | | | | | | | |
| | 873-C | 2499 | 2749 | 2867 | 3120 | 3372 | 3625 | 3877 | 4129 | 4382 | 4634 | 4886 | 5139 | 5431 | 6339 | |
| | | <i>Reversible Loose Seat Cushion / Tight Back / 1000 lb. Weight Capacity</i> | | | | | | | | | | | | | | |

DESCRIPTION:

- Upholstery Frames: Hardwood & Plywood
- Seat: High Density Polyurethane Foam Over Sheet Webbing
- Back: High Density Polyurethane Foam Over Sinuous Wire Springs
- Loose Cushions: High Density Polydacron
- Leather / Vinyl Cushions Are Not Reversible
- Integral Exposed Wood Legs: Solid Maple
- 10 Year Warranty

OPTIONS:

- ARL Brushed Aluminum Round Legs (Set Of 4).....\$353
- PM1 Power/Data Module (1-Power / 1-USB 2 Port Simplex Charger)\$859
(Additional Power/Data Modules Available - See Quads Options)

Feather Down & Polyester Pillows Available (See Page 5)
Specify Exposed Wood Finish (See Page 6)
Tablet Arm / Cup Holder Options (See Quads Options Pages)

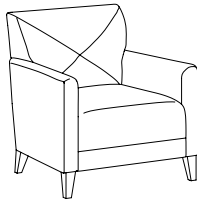
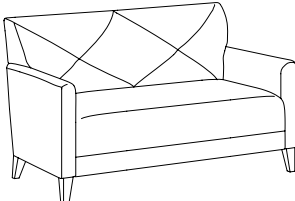
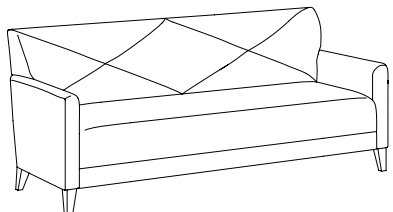
| Q2 LOUNGE | | ITEM #: | SPECIFICATIONS GRADES LIST PRICES: | | | | | | | | | | | | | |
|--|------------------|---------|--|------------|----------|-------------------------|----------|----------|---|----------|----------|----------|----------|-----------|-----------|-----------|
|  | LOUNGE CHAIR | | Overall: 29"w 31"d 33"h | | | Arm: 22.5"h | | | COM: 4.75 yds. (874-P) / 4.75 yds. (874-C) | | | | | | | |
| | | | Seat: 22"w 21"d 17"h | | | Weight: 75 lbs. | | | COL: 86 sq.ft. (874-P) / 86 sq.ft. (874-C) | | | | | | | |
| | | | COM | COL | 1 | 2 | 3 | 4 | 5 | 6 | 7 | 8 | 9 | 10 | L1 | L2 |
| | 874-P | | 1431 | 1574 | 1605 | 1731 | 1857 | 1984 | 2110 | 2236 | 2362 | 2488 | 2615 | 2741 | 2908 | 3362 |
| | | | <i>Tight Seat / Diagonally Sewn Buttonless Tufted Back / 500 lb. Weight Capacity</i> | | | | | | | | | | | | | |
| | 874-C | | 1450 | 1595 | 1623 | 1749 | 1875 | 2001 | 2128 | 2254 | 2380 | 2506 | 2632 | 2759 | 2927 | 3381 |
| | | | <i>Reversible Loose Seat Cushion / Diagonally Sewn Buttonless Tufted Back / 500 lb. Weight Capacity</i> | | | | | | | | | | | | | |
|  | TWO PLACE SOFA | | Overall: 53"w 31"d 33"h | | | Arm: 22.5"h | | | COM: 6.5 yds. (875-P) / 7 yds. (875-C) | | | | | | | |
| | | | Seat: 46"w 21"d 17"h | | | Weight: 100 lbs. | | | COL: 117 sq.ft. (875-P) / 126 sq.ft. (875-C) | | | | | | | |
| | | | COM | COL | 1 | 2 | 3 | 4 | 5 | 6 | 7 | 8 | 9 | 10 | L1 | L2 |
| | 875-P | | 2025 | 2227 | 2265 | 2440 | 2615 | 2790 | 2966 | 3141 | 3316 | 3491 | 3667 | 3842 | 4062 | 4693 |
| | | | <i>Tight Seat / Diagonally Sewn Buttonless Tufted Back / 750 lb. Weight Capacity</i> | | | | | | | | | | | | | |
| | 875-C | | 2052 | 2257 | 2333 | 2529 | 2725 | 2921 | 3118 | 3314 | 3510 | 3707 | 3903 | 4099 | 4341 | 5048 |
| | | | <i>Reversible Loose Seat Cushion / Diagonally Sewn Buttonless Tufted Back / 750 lb. Weight Capacity</i> | | | | | | | | | | | | | |
|  | THREE PLACE SOFA | | Overall: 76.5"w 31"d 33"h | | | Arm: 22.5"h | | | COM: 8.75 yds. (876-P) / 9.25 yds. (876-C) | | | | | | | |
| | | | Seat: 69.5"w 21"d 17"h | | | Weight: 130 lbs. | | | COL: 158 sq.ft. (876-P) / 167 sq.ft. (876-C) | | | | | | | |
| | | | COM | COL | 1 | 2 | 3 | 4 | 5 | 6 | 7 | 8 | 9 | 10 | L1 | L2 |
| | 876-P | | 2502 | 2752 | 2842 | 3081 | 3319 | 3557 | 3796 | 4034 | 4272 | 4511 | 4749 | 4987 | 5268 | 6126 |
| | | | <i>Tight Seat / Diagonally Sewn Buttonless Tufted Back / 1000 lb. Weight Capacity</i> | | | | | | | | | | | | | |
| | 876-C | | 2543 | 2797 | 2909 | 3161 | 3413 | 3666 | 3918 | 4170 | 4423 | 4675 | 4928 | 5180 | 5478 | 6387 |
| | | | <i>Reversible Loose Seat Cushion / Diagonally Sewn Buttonless Tufted Back / 1000 lb. Weight Capacity</i> | | | | | | | | | | | | | |

DESCRIPTION:

- Upholstery Frames: Hardwood & Plywood
- Seat: High Density Polyurethane Foam Over Sheet Webbing
- Back: High Density Polyurethane Foam Over Sinuous Wire Springs
- Loose Cushions: High Density Polydacron
- Leather / Vinyl Cushions Are Not Reversible
- Integral Exposed Wood Legs: Solid Maple
- 10 Year Warranty

OPTIONS:

- ARL-2 Aluminum Round Legs (Set Of 2).....\$344
- QWAC Solid Wood Arm Caps (Set Of 2).....\$198
- PM1 Power/Data Module (1-Power / 1-USB 2 Port Simplex Charger)\$859
(Additional Power/Data Modules Available - See Quads Options)

Feather Down & Polyester Pillows Available (See Page 5)
 Specify Exposed Wood Finish (See Page 6)
 Tablet Arm / Cup Holder Options (See Quads Options Pages)
 Casters Replace Rear Legs (See Quads Options Pages)

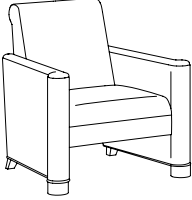
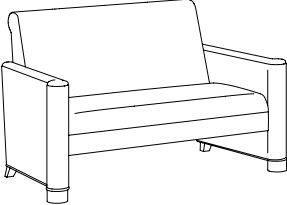
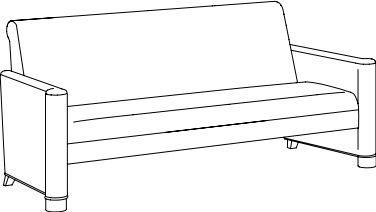
| Q3 LOUNGE | | ITEM #: | SPECIFICATIONS GRADES LIST PRICES: | | | | | | | | | | | | | |
|--|-------------------------|--|--|------------|----------|-------------------------|----------|----------|---|----------|----------|----------|----------|-----------|-----------|-----------|
|  | LOUNGE CHAIR | | Overall: 31.5"w 33"d 33"h | | | Arm: 22.5"h | | | COM: 5 yds. (881-P) / 5.5 yds. (881-C) | | | | | | | |
| | | | Seat: 23"w 19.5"d 17.5"h | | | Weight: 75 lbs. | | | COL: 90 sq.ft. (881-P) / 99 sq.ft. (881-C) | | | | | | | |
| | | | COM | COL | 1 | 2 | 3 | 4 | 5 | 6 | 7 | 8 | 9 | 10 | L1 | L2 |
| | 881-P | 1679 | 1847 | 1854 | 1987 | 2120 | 2253 | 2386 | 2520 | 2653 | 2786 | 2919 | 3052 | 3229 | 3708 | |
| | | <i>Tight Seat / Tight Back / 500 lb. Weight Capacity</i> | | | | | | | | | | | | | | |
| | 881-C | 1683 | 1851 | 1886 | 2033 | 2180 | 2327 | 2474 | 2622 | 2769 | 2916 | 3063 | 3210 | 3398 | 3928 | |
| | | <i>Reversible Loose Seat Cushion / Tight Back / 500 lb. Weight Capacity</i> | | | | | | | | | | | | | | |
|  | TWO PLACE SOFA | | Overall: 54.5"w 33"d 33"h | | | Arm: 22.5"h | | | COM: 6.5 yds. (882-P) / 7 yds. (882-C) | | | | | | | |
| | | | Seat: 46"w 19.5"d 17.5"h | | | Weight: 100 lbs. | | | COL: 117 sq.ft. (882-P) / 126 sq.ft. (882-C) | | | | | | | |
| | | | COM | COL | 1 | 2 | 3 | 4 | 5 | 6 | 7 | 8 | 9 | 10 | L1 | L2 |
| | 882-P | 2287 | 2516 | 2513 | 2688 | 2864 | 3039 | 3214 | 3389 | 3564 | 3740 | 3915 | 4090 | 4314 | 4945 | |
| | | <i>Tight Seat / Tight Back / 750 lb. Weight Capacity</i> | | | | | | | | | | | | | | |
| | 882-C | 2315 | 2546 | 2567 | 2756 | 2946 | 3135 | 3324 | 3514 | 3703 | 3892 | 4081 | 4271 | 4510 | 5191 | |
| | | <i>Reversible Loose Seat Cushion / Tight Back / 750 lb. Weight Capacity</i> | | | | | | | | | | | | | | |
|  | THREE PLACE SOFA | | Overall: 78"w 33"d 33"h | | | Arm: 22.5"h | | | COM: 8 yds. (883-P) / 9 yds. (883-C) | | | | | | | |
| | | | Seat: 69.5"w 19.5"d 17.5"h | | | Weight: 130 lbs. | | | COL: 144 sq.ft. (883-P) / 162 sq.ft. (883-C) | | | | | | | |
| | | | COM | COL | 1 | 2 | 3 | 4 | 5 | 6 | 7 | 8 | 9 | 10 | L1 | L2 |
| | 883-P | 2794 | 3074 | 3077 | 3294 | 3511 | 3729 | 3946 | 4163 | 4380 | 4598 | 4815 | 5032 | 5302 | 6084 | |
| | | <i>Tight Seat / Tight Back / 1000 lb. Weight Capacity</i> | | | | | | | | | | | | | | |
| | 883-C | 2822 | 3104 | 3159 | 3404 | 3650 | 3895 | 4140 | 4386 | 4631 | 4876 | 5122 | 5367 | 5664 | 6547 | |
| | | <i>Reversible Loose Seat Cushion / Tight Back / 1000 lb. Weight Capacity</i> | | | | | | | | | | | | | | |

DESCRIPTION:

- Upholstery Frames: Hardwood & Plywood
- Seat: High Density Polyurethane Foam Over Sheet Webbing
- Back: High Density Polyurethane Foam Over Sinuous Wire Springs
- Loose Cushions: High Density Polydacron
- Leather / Vinyl Cushions Are Not Reversible
- Integral Exposed Wood Legs: Solid Maple
- 10 Year Warranty

OPTIONS:

- ARL-2 Aluminum Round Legs (Set Of 2).....\$344
- QWAC Solid Wood Arm Caps (Set Of 2).....\$198
- PM1 Power/Data Module (1-Power / 1-USB 2 Port Simplex Charger)\$859
(Additional Power/Data Modules Available - See Quads Options)

Feather Down & Polyester Pillows Available (See Page 5)
 Specify Exposed Wood Finish (See Page 6)
 Tablet Arm / Cup Holder Options (See Quads Options Pages)
 Casters Replace Rear Legs (See Quads Options Pages)

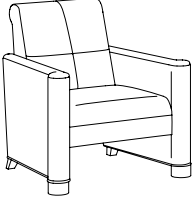
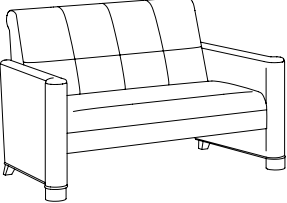
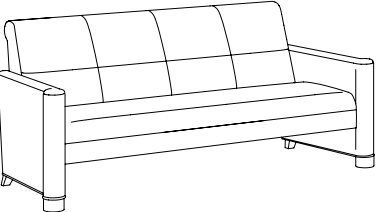
| Q3 LOUNGE | | ITEM #: | SPECIFICATIONS GRADES LIST PRICES: | | | | | | | | | | | | | |
|---|-------------------------|---|--|------------|----------|-------------------------|----------|----------|---|----------|----------|----------|----------|-----------|-----------|-----------|
|  | LOUNGE CHAIR | | Overall: 31.5"w 33"d 33"h | | | Arm: 22.5"h | | | COM: 5 yds. (884-P) / 5.5 yds. (884-C) | | | | | | | |
| | | | Seat: 23"w 19.5"d 17.5"h | | | Weight: 75 lbs. | | | COL: 90 sq.ft. (884-P) / 99 sq.ft. (884-C) | | | | | | | |
| | | | COM | COL | 1 | 2 | 3 | 4 | 5 | 6 | 7 | 8 | 9 | 10 | L1 | L2 |
| | 884-P | 1700 | 1870 | 1873 | 2007 | 2140 | 2273 | 2406 | 2539 | 2673 | 2806 | 2939 | 3072 | 3251 | 3731 | |
| | | <i>Tight Seat / Sewn Buttonless Tufted Back / 500 lb. Weight Capacity</i> | | | | | | | | | | | | | | |
| | 884-C | 1701 | 1871 | 1902 | 2050 | 2197 | 2344 | 2491 | 2638 | 2786 | 2933 | 3080 | 3227 | 3417 | 3947 | |
| | | <i>Reversible Loose Seat Cushion / Sewn Buttonless Tufted Back / 500 lb. Weight Capacity</i> | | | | | | | | | | | | | | |
|  | TWO PLACE SOFA | | Overall: 54.5"w 33"d 33"h | | | Arm: 22.5"h | | | COM: 6.5 yds. (885-P) / 7 yds. (885-C) | | | | | | | |
| | | | Seat: 46"w 19.5"d 17.5"h | | | Weight: 100 lbs. | | | COL: 117 sq.ft. (885-P) / 126 sq.ft. (885-C) | | | | | | | |
| | | | COM | COL | 1 | 2 | 3 | 4 | 5 | 6 | 7 | 8 | 9 | 10 | L1 | L2 |
| | 885-P | 2323 | 2556 | 2547 | 2722 | 2897 | 3073 | 3248 | 3423 | 3598 | 3774 | 3949 | 4124 | 4353 | 4984 | |
| | | <i>Tight Seat / Sewn Buttonless Tufted Back / 750 lb. Weight Capacity</i> | | | | | | | | | | | | | | |
| | 885-C | 2345 | 2579 | 2595 | 2785 | 2974 | 3163 | 3352 | 3542 | 3731 | 3920 | 4109 | 4299 | 4543 | 5224 | |
| | | <i>Reversible Loose Seat Cushion / Sewn Buttonless Tufted Back / 750 lb. Weight Capacity</i> | | | | | | | | | | | | | | |
|  | THREE PLACE SOFA | | Overall: 78"w 33"d 33"h | | | Arm: 22.5"h | | | COM: 8.25 yds. (886-P) / 9.25 yds. (886-C) | | | | | | | |
| | | | Seat: 69.5"w 19.5"d 17.5"h | | | Weight: 130 lbs. | | | COL: 149 sq.ft. (886-P) / 167 sq.ft. (886-C) | | | | | | | |
| | | | COM | COL | 1 | 2 | 3 | 4 | 5 | 6 | 7 | 8 | 9 | 10 | L1 | L2 |
| | 886-P | 2848 | 3133 | 3142 | 3366 | 3590 | 3814 | 4039 | 4263 | 4487 | 4712 | 4936 | 5160 | 5443 | 6250 | |
| | | <i>Tight Seat / Diagonally Sewn Buttonless Tufted Back / 1000 lb. Weight Capacity</i> | | | | | | | | | | | | | | |
| | 886-C | 2870 | 3157 | 3218 | 3470 | 3723 | 3975 | 4227 | 4480 | 4732 | 4985 | 5237 | 5489 | 5798 | 6706 | |
| | | <i>Reversible Loose Seat Cushion / Sewn Buttonless Tufted Back / 1000 lb. Weight Capacity</i> | | | | | | | | | | | | | | |

DESCRIPTION:

- Upholstery Frames: Hardwood & Plywood
- Seat: High Density Polyurethane Foam Over Sheet Webbing
- Back: High Density Polyurethane Foam Over Sinuous Wire Springs
- Loose Cushions: High Density Polydacron
- Leather / Vinyl Cushions Are Not Reversible
- Integral Exposed Wood Legs: Solid Maple
- 10 Year Warranty

OPTIONS:

- ASL Aluminum Square Legs (Set Of 4).....\$382
- PM1 Power/Data Module (1-Power / 1-USB 2 Port Simplex Charger)\$859
(Additional Power/Data Modules Available - See Quads Options)

Feather Down & Polyester Pillows Available (See Page 5)
Specify Exposed Wood Finish (See Page 6)
Tablet Arm / Cup Holder Options (See Quads Options Pages)

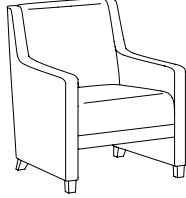
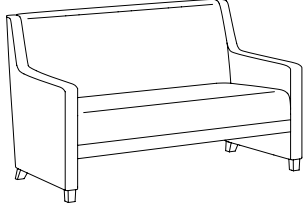
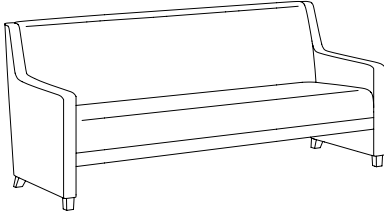
| Q4 LOUNGE | | ITEM #: | SPECIFICATIONS GRADES LIST PRICES: | | | | | | | | | | | | | |
|--|------------------|--|--|------------|----------|-------------------------|----------|----------|---|----------|----------|----------|----------|-----------|-----------|-----------|
|  | LOUNGE CHAIR | | Overall: 29"w 30"d 33"h | | | Arm: 23"h | | | COM: 5.5 yds. (891-P) / 6 yds. (891-C) | | | | | | | |
| | | | Seat: 22"w 20"d 18"h | | | Weight: 75 lbs. | | | COL: 99 sq.ft. (891-P) / 108 sq.ft. (891-C) | | | | | | | |
| | | | COM | COL | 1 | 2 | 3 | 4 | 5 | 6 | 7 | 8 | 9 | 10 | L1 | L2 |
| | 891-P | 1621 | 1783 | 1827 | 1974 | 2121 | 2268 | 2416 | 2563 | 2710 | 2857 | 3004 | 3152 | 3353 | 3883 | |
| | | <i>Tight Seat / Tight Back / 500 lb. Weight Capacity</i> | | | | | | | | | | | | | | |
| | 891-C | 1625 | 1787 | 1859 | 2020 | 2181 | 2342 | 2504 | 2665 | 2826 | 2987 | 3149 | 3310 | 3522 | 4103 | |
| | | <i>Reversible Loose Seat Cushion / Tight Back / 500 lb. Weight Capacity</i> | | | | | | | | | | | | | | |
|  | TWO PLACE SOFA | | Overall: 53"w 30"d 33"h | | | Arm: 23"h | | | COM: 7 yds. (892-P) / 7.75 yds. (892-C) | | | | | | | |
| | | | Seat: 46"w 20"d 18"h | | | Weight: 100 lbs. | | | COL: 126 sq.ft. (892-P) / 140 sq.ft. (892-C) | | | | | | | |
| | | | COM | COL | 1 | 2 | 3 | 4 | 5 | 6 | 7 | 8 | 9 | 10 | L1 | L2 |
| | 892-P | 2223 | 2446 | 2481 | 2670 | 2859 | 3048 | 3238 | 3427 | 3616 | 3805 | 3995 | 4184 | 4432 | 5114 | |
| | | <i>Tight Seat / Tight Back / 750 lb. Weight Capacity</i> | | | | | | | | | | | | | | |
| | 892-C | 2257 | 2483 | 2554 | 2765 | 2975 | 3185 | 3396 | 3606 | 3816 | 4026 | 4237 | 4447 | 4716 | 5473 | |
| | | <i>Reversible Loose Seat Cushion / Tight Back / 750 lb. Weight Capacity</i> | | | | | | | | | | | | | | |
|  | THREE PLACE SOFA | | Overall: 76.5"w 30"d 33"h | | | Arm: 23"h | | | COM: 9.75 yds. (893-P) / 10.75 yds. (893-C) | | | | | | | |
| | | | Seat: 69.5"w 20"d 18"h | | | Weight: 130 lbs. | | | COL: 176 sq.ft. (893-P) / 194 sq.ft. (893-C) | | | | | | | |
| | | | COM | COL | 1 | 2 | 3 | 4 | 5 | 6 | 7 | 8 | 9 | 10 | L1 | L2 |
| | 893-P | 2707 | 2978 | 3092 | 3358 | 3625 | 3891 | 4157 | 4424 | 4690 | 4957 | 5223 | 5489 | 5808 | 6767 | |
| | | <i>Tight Seat / Tight Back / 1000 lb. Weight Capacity</i> | | | | | | | | | | | | | | |
| | 893-C | 2758 | 3034 | 3197 | 3491 | 3786 | 4080 | 4374 | 4669 | 4963 | 5258 | 5552 | 5846 | 6193 | 7252 | |
| | | <i>Reversible Loose Seat Cushion / Tight Back / 1000 lb. Weight Capacity</i> | | | | | | | | | | | | | | |

DESCRIPTION:

- Upholstery Frames: Hardwood & Plywood
- Seat: High Density Polyurethane Foam Over Sheet Webbing
- Back: High Density Polyurethane Foam Over Sinuous Wire Springs
- Loose Cushions: High Density Polydacron
- Leather / Vinyl Cushions Are Not Reversible
- Integral Exposed Wood Legs: Solid Maple
- 10 Year Warranty

OPTIONS:





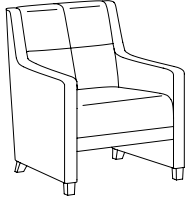
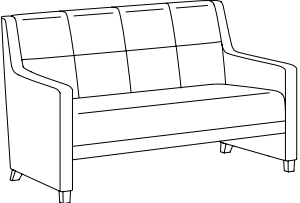
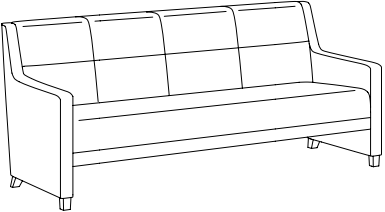

- ASL Aluminum Square Legs (Set Of 4).....\$382
- PM1 Power/Data Module (1-Power / 1-USB 2 Port Simplex Charger)\$859
(Additional Power/Data Modules Available - See Quads Options)

Feather Down & Polyester Pillows Available (See Page 5)
Specify Exposed Wood Finish (See Page 6)
Tablet Arm / Cup Holder Options (See Quads Options Pages)

| Q4 LOUNGE | | ITEM #: | SPECIFICATIONS GRADES LIST PRICES: | | | | | | | | | | | | | |
|--|------------------|---|--|------------|----------|-------------------------|----------|----------|---|----------|----------|----------|----------|-----------|-----------|-----------|
|  | LOUNGE CHAIR | | Overall: 29"w 30"d 33"h | | | Arm: 23"h | | | COM: 5.5 yds. (894-P) / 6 yds. (894-C) | | | | | | | |
| | | | Seat: 22"w 20"d 18"h | | | Weight: 75 lbs. | | | COL: 99 sq.ft. (894-P) / 108 sq.ft. (894-C) | | | | | | | |
| | | | COM | COL | 1 | 2 | 3 | 4 | 5 | 6 | 7 | 8 | 9 | 10 | L1 | L2 |
| | 894-P | 1636 | 1799 | 1841 | 1988 | 2135 | 2283 | 2430 | 2577 | 2724 | 2871 | 3019 | 3166 | 3370 | 3900 | |
| | | <i>Tight Seat / Sewn Buttonless Tufted Back / 500 lb. Weight Capacity</i> | | | | | | | | | | | | | | |
| | 894-C | 1643 | 1807 | 1876 | 2037 | 2198 | 2359 | 2521 | 2682 | 2843 | 3004 | 3165 | 3327 | 3541 | 4122 | |
| | | <i>Reversible Loose Seat Cushion / Sewn Buttonless Tufted Back / 500 lb. Weight Capacity</i> | | | | | | | | | | | | | | |
|  | TWO PLACE SOFA | | Overall: 53"w 30"d 33"h | | | Arm: 23"h | | | COM: 7.25 yds. (895-P) / 7.75 yds. (895-C) | | | | | | | |
| | | | Seat: 46"w 20"d 18"h | | | Weight: 100 lbs. | | | COL: 131 sq.ft. (895-P) / 140 sq.ft. (895-C) | | | | | | | |
| | | | COM | COL | 1 | 2 | 3 | 4 | 5 | 6 | 7 | 8 | 9 | 10 | L1 | L2 |
| | 895-P | 2247 | 2472 | 2517 | 2714 | 2910 | 3106 | 3302 | 3499 | 3695 | 3891 | 4088 | 4284 | 4543 | 5249 | |
| | | <i>Tight Seat / Sewn Buttonless Tufted Back / 750 lb. Weight Capacity</i> | | | | | | | | | | | | | | |
| | 895-C | 2287 | 2515 | 2597 | 2814 | 3031 | 3248 | 3466 | 3683 | 3900 | 4118 | 4335 | 4552 | 4831 | 5613 | |
| | | <i>Reversible Loose Seat Cushion / Sewn Buttonless Tufted Back / 750 lb. Weight Capacity</i> | | | | | | | | | | | | | | |
|  | THREE PLACE SOFA | | Overall: 76.5"w 30"d 33"h | | | Arm: 23"h | | | COM: 9.75 yds. (896-P) / 10.75 yds. (896-C) | | | | | | | |
| | | | Seat: 69.5"w 20"d 18"h | | | Weight: 130 lbs. | | | COL: 176 sq.ft. (896-P) / 194 sq.ft. (896-C) | | | | | | | |
| | | | COM | COL | 1 | 2 | 3 | 4 | 5 | 6 | 7 | 8 | 9 | 10 | L1 | L2 |
| | 896-P | 2755 | 3030 | 3137 | 3404 | 3670 | 3936 | 4203 | 4469 | 4735 | 5002 | 5268 | 5535 | 5861 | 6820 | |
| | | <i>Tight Seat / Sewn Buttonless Tufted Back / 1000 lb. Weight Capacity</i> | | | | | | | | | | | | | | |
| | 896-C | 2800 | 3080 | 3236 | 3531 | 3825 | 4119 | 4414 | 4708 | 5003 | 5297 | 5591 | 5886 | 6239 | 7299 | |
| | | <i>Reversible Loose Seat Cushion / Sewn Buttonless Tufted Back / 1000 lb. Weight Capacity</i> | | | | | | | | | | | | | | |

| LEGS | OPTION #: | SPECIFICATIONS LIST PRICES AVAILABILITY: |
|---|---------------------|--|
| <p>BRUSHED ALUMINUM ROUND LEGS</p>  | <p>ARL</p> | <p><i>Overall: 2" Diameter 5"h</i></p> <hr/> <p>\$353 (Set Of 4) <i>(Brushed Aluminum Finish)</i></p> <p><i>Available: Quads 1 / Quads 2 Collections</i></p> |
| <p>ALUMINUM ROUND LEGS (SHORT)</p>  | <p>ARL-2</p> | <p><i>Overall: 3" Diameter 2.25"h</i></p> <hr/> <p>\$344 (Set Of 2) <i>(Brushed Finish)</i></p> <p><i>Available: Quads 3 Collection</i></p> |
| <p>ALUMINUM SQUARE LEGS</p>  | <p>ASL</p> | <p><i>Overall: 2.25"w 2.25"d 2.25"h</i></p> <hr/> <p>\$382 (Set Of 4) <i>(Brushed Finish)</i></p> <p><i>Available: Quads 4 Collection</i></p> |

| TABLETS / ARM CAPS | OPTION #: | SPECIFICATIONS LIST PRICES AVAILABILITY: |
|---|---|--|
| <p>TABLET ARMS / CUP HOLDER</p>  <p>Laminate Tablet Arm Shown w/ Cup Holder</p>  <p>Veneer Tablet Arm Shown w/ Cup Holder</p>  <p>Solid Surface Tablet Arm Shown w/ Cup Holder</p> | <p>Overall: 14" Diameter .75"h</p> <hr/> <p>TA-L \$509 <i>Tablet Arm With 360° Rotation - High Pressure Laminate. (Specify Laminate / Specify Left Or Right Facing Arm Location)</i></p> <p>TA-V \$580 <i>Tablet Arm With 360° Rotation - Sunburst Cherry Veneer. (Specify Finish / Specify Left Or Right Facing Arm Location)</i></p> <p>TA-C \$698 <i>Tablet Arm With 360° Rotation - White Solid Surface. (Available In White Only / Specify Left Or Right Facing Arm Location)</i></p> <p>CH-1 \$129 <i>Black Plastic Cup Holder (Only Available If Used With Tablet Arm)</i></p> <p>CH-2 \$186 <i>Spun Aluminum Cup Holder (Only Available If Used With Tablet Arm)</i></p> <p>Available: Quads Collection</p> | |
| <p>FOLD DOWN TABLET ARM</p>   | <p>Overall: 14" Diameter .75"h</p> <hr/> <p>FDTA-L \$1065 <i>Tablet Arm With 360° Rotation - High Pressure Laminate. (Specify Laminate / Specify Left Or Right Facing Arm Location)</i></p> <p>FDTA-V \$1136 <i>Tablet Arm With 360° Rotation - Sunburst Cherry Veneer. (Specify Finish / Specify Left Or Right Facing Arm Location)</i></p> <p>FDTA-C \$1278 <i>Tablet Arm With 360° Rotation - White Solid Surface. (Available In White Only / Specify Left Or Right Facing Arm Location)</i></p> <p>Available: Quads Collection</p> | |
| <p>ARTICULATING / SWIVEL TABLET ARM</p>  <p>ATA-L Double Articulating / Swivel Tablet Arm</p>  <p>ATA-L w/ CH-1 Black Plastic Cup Holder</p> | <p>Overall: 14" Diameter .75"h</p> <hr/> <p>ATA-L \$983 <i>Tablet Arm With 360° Rotation - High Pressure Laminate. (Specify Laminate / Specify Left Or Right Facing Arm Location)</i></p> <p>ATA-V \$1055 <i>Tablet Arm With 360° Rotation - Sunburst Cherry Veneer. (Specify Finish / Specify Left Or Right Facing Arm Location)</i></p> <p>ATA-C \$1173 <i>Tablet Arm With 360° Rotation - White Solid Surface. (Available In White Only / Specify Left Or Right Facing Arm Location)</i></p> <p>CH-1 \$129 <i>Black Plastic Cup Holder (Only Available If Used With Tablet Arm)</i></p> <p>CH-2 \$186 <i>Spun Aluminum Cup Holder (Only Available If Used With Tablet Arm)</i></p> <p>Available: Quads Collection</p> | |
| <p>SOLID WOOD ARM CAPS</p>  | <p>Overall: 2.5"w (3.75"w "P") 30"d .75"h</p> <hr/> <p>QWAC \$198 (Set Of 2) <i>(Specify Finish)</i></p> <p>Available: Quads 3 Collection</p> | |

| CASTERS / POWER / COVERS | OPTION #: | SPECIFICATIONS LIST PRICES AVAILABILITY: |
|---|---|--|
| <p>CASTERS</p>  <p>(C1-NL / C1-L) Carpet Caster - 2" Metal Balls</p>  <p>(C2) Antique Bronze Hooded Caster - 2" Rubber Ball</p> | <p>Overall: 2"h</p> <p>C1-NL \$106 (Set Of 2) <i>Non-Locking Carpet Caster - 2" Metal Balls - Antique Windsor (Additional Finishes Available)</i></p> <p>C1-L \$149 (Set Of 2) <i>Locking Carpet Caster - 2" Metal Balls (Additional Finishes Available)</i></p> <p>C2 \$115 (Set Of 2) <i>Antique Bronze Hooded Caster - 2" Rubber Ball (Additional Finishes Available)</i></p> <p>Available: Quads 3 Collection</p> | |
| <p>POWER / DATA MODULE</p>  <p>PM1 Power / Data Module</p>  <p>PM2 Power Module</p>  <p>USB-1 Dual Charging USB</p> | <p>PM1 Overall: 5.25"w 1.25"d 4.25"h PM2 Overall: 2"w 2"d .125"h USB-1 Overall: 2"w 2"d .125"h</p> <p>PM1 \$859 Power/Data Module (1-Power / 1-USB 2 Port Simplex Charger Standard) <i>Vertical / Horizontal Mount Power Module. Price Varies By Socket. Contact Customer Service For Quote. (Additional Colors Available)</i></p> <p>PM2 \$238 Power Module (1-Power) <i>Spill-Proof Technology / Multiple Finish Options / Storm Color Standard (Specify Left or Right Facing)</i></p> <p>USB-1 \$238 Dual Charging USB (2 Port Simplex Charger Standard) <i>Spill-Proof Technology / 2 Amps Per Port / Multiple Finish Options / Storm Color Standard (Specify Left or Right Facing)</i></p> <p>Available: Quads Collection</p> | |
| <p>CONTRASTING COVERS</p>  | <p>Overall: n/a</p> <p>CC \$129 <i>NOTE: If Two Or More Upholsteries Or Leathers Are Used On Any Piece Of Furniture, Then A Contrast Charge Will Apply Per Order. When Using Trinity Upholstery, The Higher Priced Upholstery Grade Will Be Used In Pricing, Unless It's Trinity Leather With Fabric Contrast Welt, Or COM With Trinity Contrast Welt, Then Contact Customer Service For Pricing.</i></p> <p>Available: Quads Collection</p> | |

Savoye

LOUNGE SEATING

Effective: March 1, 2025

T R I N I T Y

Date:

Page:

Modification:

Description:

DESCRIPTION:

- Upholstery Frames: Plywood
- Seat & Back: High Density Polyurethane Foam Over Plywood
- Legs: Standard Black Powdercoat Over Steel
(Optional Polished Stainless Steel Legs Available)
- 10 Year Warranty

OPTIONS:

- PSL-1 Polished Stainless Steel Legs\$594
(Replaces Standard Black Powdercoat Legs On Lounge Unit)
- PM1 Power/Data Module (1-Power / 1-USB 2 Port Simplex Charger)\$859
(Additional Power/Data Modules Available - See Savoie Options)

Feather Down & Polyester Pillows Available (See Page 5)
Tablet Arm / Cup Holder Options (See Savoie Options Pages)

LOUNGE

ITEM #: SPECIFICATIONS | GRADES | LIST PRICES:

LOUNGE CHAIR / ARMS LEFT & RIGHT / FULLY UPHOLSTERED

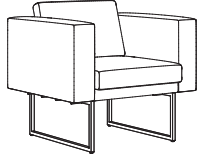

1001-S

Overall: 32"w 29"d 30"h **Arm:** 26"h **COM:** 5.25 yds.
Seat: 22"w 19.75"d 18"h **Weight:** tbd lbs. **COL:** 94.5 sq.ft.

| COM | COL | 1 | 2 | 3 | 4 | 5 | 6 | 7 | 8 | 9 | 10 | L1 | L2 |
|------|------|------|------|------|------|------|------|------|------|------|------|------|------|
| 1560 | 1716 | 1750 | 1887 | 2024 | 2162 | 2299 | 2437 | 2574 | 2712 | 2849 | 2987 | 3135 | 3630 |

Tight Seat & Back / 500 lb. Weight Capacity

ONE PLACE LOUNGE / ARM LEFT / FULLY UPHOLSTERED

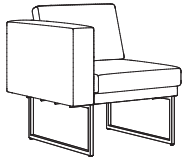

1002-S

Overall: 27"w 29"d 30"h **Arm:** 26"h **COM:** 4.25 yds.
Seat: 22"w 19.75"d 18"h **Weight:** tbd lbs. **COL:** 76.5 sq.ft.

| COM | COL | 1 | 2 | 3 | 4 | 5 | 6 | 7 | 8 | 9 | 10 | L1 | L2 |
|------|------|------|------|------|------|------|------|------|------|------|------|------|------|
| 1359 | 1495 | 1505 | 1615 | 1725 | 1835 | 1945 | 2055 | 2164 | 2274 | 2384 | 2494 | 2615 | 3010 |

Tight Seat & Back / 500 lb. Weight Capacity

ONE PLACE LOUNGE / ARM RIGHT / FULLY UPHOLSTERED

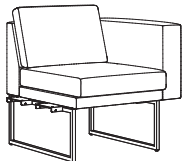

1003-S

Overall: 27"w 29"d 30"h **Arm:** 26"h **COM:** 4.25 yds.
Seat: 22"w 19.75"d 18"h **Weight:** tbd lbs. **COL:** 76.5 sq.ft.

| COM | COL | 1 | 2 | 3 | 4 | 5 | 6 | 7 | 8 | 9 | 10 | L1 | L2 |
|------|------|------|------|------|------|------|------|------|------|------|------|------|------|
| 1359 | 1495 | 1505 | 1615 | 1725 | 1835 | 1945 | 2055 | 2164 | 2274 | 2384 | 2494 | 2615 | 3010 |

Tight Seat & Back / 500 lb. Weight Capacity

ONE PLACE LOUNGE / ARMLESS / FULLY UPHOLSTERED

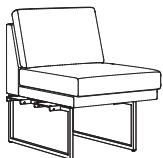

Left Hookup



Right Hookup

1004-S

Overall: 22"w 29"d 30"h **Arm:** n/a **COM:** 3.25 yds.
Seat: 22"w 19.75"d 18"h **Weight:** tbd lbs. **COL:** 58.5 sq.ft.

| COM | COL | 1 | 2 | 3 | 4 | 5 | 6 | 7 | 8 | 9 | 10 | L1 | L2 |
|------|------|------|------|------|------|------|------|------|------|------|------|------|------|
| 1137 | 1250 | 1240 | 1322 | 1405 | 1487 | 1570 | 1652 | 1735 | 1817 | 1899 | 1982 | 2069 | 2366 |

Tight Seat & Back / 500 lb. Weight Capacity

Specify Left Or Right Hookup

ONE PLACE BENCH / FULLY UPHOLSTERED



Left Hookup

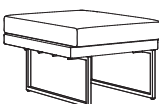

Right Hookup

1005-B

Overall: 22"w 29"d 18"h **Arm:** n/a **COM:** 2.25 yds.
Seat: 22"w 29"d 18"h **Weight:** tbd lbs. **COL:** 40.5 sq.ft.

| COM | COL | 1 | 2 | 3 | 4 | 5 | 6 | 7 | 8 | 9 | 10 | L1 | L2 |
|-----|------|------|------|------|------|------|------|------|------|------|------|------|------|
| 945 | 1039 | 1003 | 1058 | 1113 | 1168 | 1223 | 1278 | 1333 | 1388 | 1443 | 1498 | 1557 | 1755 |

Tight Seat & Back / 500 lb. Weight Capacity

Specify Left Or Right Hookup

DESCRIPTION:

- Upholstery Frames: Plywood
- Seat & Back: High Density Polyurethane Foam Over Plywood
- Legs: Standard Black Powdercoat Over Steel
(Optional Polished Stainless Steel Legs Available)
- Table: High Pressure Laminate Top
- 10 Year Warranty

OPTIONS:

- PSL-1 Polished Stainless Steel Legs\$594
(Replaces Standard Black Powdercoat Legs On Lounge Unit)
- PM1 Power/Data Module (1-Power / 1-USB 2 Port Simplex Charger)\$859
(Additional Power/Data Modules Available - See Savoie Options)

Feather Down & Polyester Pillows Available (See Page 5)
Tablet Arm / Cup Holder Options (See Savoie Options Pages)

LOUNGE

ITEM #: SPECIFICATIONS | GRADES | LIST PRICES:

ONE PLACE TABLE

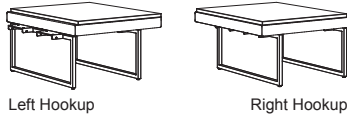

Left Hookup

Right Hookup

1006-T

Overall: 22"w 29"d 14"h **Arm:** n/a **COM:** 1.25 yds.
Seat: n/a **Weight:** tbd lbs. **COL:** 22.5 sq.ft.

| COM | COL | 1 | 2 | 3 | 4 | 5 | 6 | 7 | 8 | 9 | 10 | L1 | L2 |
|-----|-----|---|---|---|---|---|---|---|---|---|----|----|----|
|-----|-----|---|---|---|---|---|---|---|---|---|----|----|----|

| | | | | | | | | | | | | | |
|------|------|------|------|------|------|------|------|------|------|------|------|------|------|
| 1057 | 1162 | 1054 | 1081 | 1109 | 1136 | 1164 | 1191 | 1219 | 1246 | 1274 | 1301 | 1331 | 1430 |
|------|------|------|------|------|------|------|------|------|------|------|------|------|------|

High Pressure Laminate Top / 500 lb. Weight Capacity

Specify Left Or Right Hookup

CORNER SEAT / TWO BACKS / FULLY UPHOLSTERED

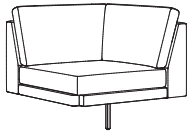

1012-CS

Overall: 29"w 29"d 30"h **Arm:** n/a **COM:** 5 yds.
Seat: 22"w 19.75"d 18"h **Weight:** tbd lbs. **COL:** 90 sq.ft.

| COM | COL | 1 | 2 | 3 | 4 | 5 | 6 | 7 | 8 | 9 | 10 | L1 | L2 |
|-----|-----|---|---|---|---|---|---|---|---|---|----|----|----|
|-----|-----|---|---|---|---|---|---|---|---|---|----|----|----|

| | | | | | | | | | | | | | |
|------|------|------|------|------|------|------|------|------|------|------|------|------|------|
| 1096 | 1205 | 1297 | 1428 | 1558 | 1689 | 1819 | 1950 | 2081 | 2211 | 2342 | 2472 | 2610 | 3080 |
|------|------|------|------|------|------|------|------|------|------|------|------|------|------|

Tight Seat & Back / 500 lb. Weight Capacity

CORNER BENCH / FULLY UPHOLSTERED



1013-CB

Overall: 29"w 29"d 18"h **Arm:** n/a **COM:** 2.25 yds.
Seat: 29"w 29"d 18"h **Weight:** tbd lbs. **COL:** 40.5 sq.ft.

| COM | COL | 1 | 2 | 3 | 4 | 5 | 6 | 7 | 8 | 9 | 10 | L1 | L2 |
|-----|-----|---|---|---|---|---|---|---|---|---|----|----|----|
|-----|-----|---|---|---|---|---|---|---|---|---|----|----|----|

| | | | | | | | | | | | | | |
|-----|-----|-----|-----|-----|-----|-----|-----|------|------|------|------|------|------|
| 631 | 694 | 707 | 761 | 816 | 871 | 926 | 981 | 1036 | 1091 | 1146 | 1201 | 1260 | 1458 |
|-----|-----|-----|-----|-----|-----|-----|-----|------|------|------|------|------|------|

Tight Seat / 500 lb. Weight Capacity

CORNER TABLE



1014-CT

Overall: 29"w 29"d 14"h **Arm:** n/a **COM:** 1.25 yds.
Seat: n/a **Weight:** tbd lbs. **COL:** 22.5 sq.ft.

| COM | COL | 1 | 2 | 3 | 4 | 5 | 6 | 7 | 8 | 9 | 10 | L1 | L2 |
|-----|-----|---|---|---|---|---|---|---|---|---|----|----|----|
|-----|-----|---|---|---|---|---|---|---|---|---|----|----|----|

| | | | | | | | | | | | | | |
|-----|-----|-----|-----|-----|-----|-----|-----|-----|-----|------|------|------|------|
| 772 | 849 | 784 | 812 | 839 | 867 | 894 | 922 | 949 | 977 | 1004 | 1032 | 1062 | 1160 |
|-----|-----|-----|-----|-----|-----|-----|-----|-----|-----|------|------|------|------|

High Pressure Laminate Top / 500 lb. Weight Capacity

TWO PLACE SEAT-SEAT / ARMS LEFT & RIGHT / FULLY UPHOLSTERED

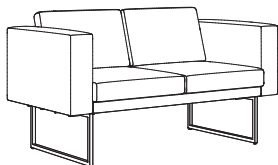

1015-SS

Overall: 54"w 29"d 30"h **Arm:** 26"h **COM:** 7 yds.
Seat: 44"w 19.75"d 18"h **Weight:** tbd lbs. **COL:** 126 sq.ft.

| COM | COL | 1 | 2 | 3 | 4 | 5 | 6 | 7 | 8 | 9 | 10 | L1 | L2 |
|-----|-----|---|---|---|---|---|---|---|---|---|----|----|----|
|-----|-----|---|---|---|---|---|---|---|---|---|----|----|----|

| | | | | | | | | | | | | | |
|------|------|------|------|------|------|------|------|------|------|------|------|------|------|
| 2125 | 2338 | 2380 | 2566 | 2751 | 2937 | 3123 | 3308 | 3494 | 3679 | 3865 | 4050 | 4261 | 4929 |
|------|------|------|------|------|------|------|------|------|------|------|------|------|------|

Tight Seat & Back

DESCRIPTION:

- Upholstery Frames: Plywood
- Seat & Back: High Density Polyurethane Foam Over Plywood
- Legs: Standard Black Powdercoat Over Steel
(Optional Polished Stainless Steel Legs Available)
- Table: High Pressure Laminate Top
- 10 Year Warranty

OPTIONS:

- PSL-1 Polished Stainless Steel Legs\$594
(Replaces Standard Black Powdercoat Legs On Lounge Unit)
- PM1 Power/Data Module (1-Power / 1-USB 2 Port Simplex Charger)\$859
(Additional Power/Data Modules Available - See Savoie Options)

Feather Down & Polyester Pillows Available (See Page 5)
Tablet Arm / Cup Holder Options (See Savoie Options Pages)

LOUNGE

ITEM #: SPECIFICATIONS | GRADES | LIST PRICES:

TWO PLACE SEAT-SEAT / ARM LEFT / FULLY UPHOLSTERED

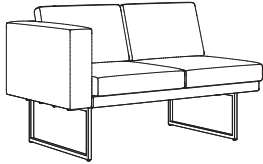

1016-SS

Overall: 49"w 29"d 30"h
Seat: 44"w 19.75"d 18"h

Arm: n/a
Weight: tbd lbs.

COM: 6 yds.
COL: 108 sq.ft.

| COM | COL | 1 | 2 | 3 | 4 | 5 | 6 | 7 | 8 | 9 | 10 | L1 | L2 |
|------|------|------|------|------|------|------|------|------|------|------|------|------|------|
| 1930 | 2123 | 2141 | 2299 | 2457 | 2615 | 2773 | 2931 | 3089 | 3247 | 3405 | 3564 | 3746 | 4315 |

Tight Seat & Back / 500 lb. Weight Capacity

TWO PLACE SEAT-SEAT / ARM RIGHT / FULLY UPHOLSTERED

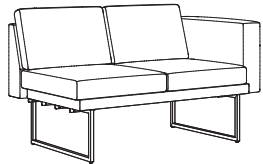

1017-SS

Overall: 49"w 29"d 30"h
Seat: 44"w 19.75"d 18"h

Arm: n/a
Weight: tbd lbs.

COM: 6 yds.
COL: 108 sq.ft.

| COM | COL | 1 | 2 | 3 | 4 | 5 | 6 | 7 | 8 | 9 | 10 | L1 | L2 |
|------|------|------|------|------|------|------|------|------|------|------|------|------|------|
| 1930 | 2123 | 2141 | 2299 | 2457 | 2615 | 2773 | 2931 | 3089 | 3247 | 3405 | 3564 | 3746 | 4315 |

Tight Seat & Back / 500 lb. Weight Capacity

TWO PLACE BENCH-SEAT / ONE ARM RIGHT-BENCH LEFT / FULLY UPHOLSTERED

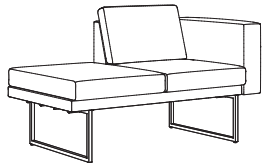

1018-BS

Overall: 49"w 29"d 30"h
Seat: 44"w 19.75"d 18"h

Arm: 26"h
Weight: tbd lbs.

COM: 4.75 yds.
COL: 85.5 sq.ft.

| COM | COL | 1 | 2 | 3 | 4 | 5 | 6 | 7 | 8 | 9 | 10 | L1 | L2 |
|------|------|------|------|------|------|------|------|------|------|------|------|------|------|
| 1767 | 1944 | 1918 | 2042 | 2166 | 2289 | 2413 | 2537 | 2661 | 2784 | 2908 | 3032 | 3182 | 3627 |

Tight Seat & Back / 500 lb. Weight Capacity

TWO PLACE SEAT-BENCH / ONE ARM LEFT-BENCH RIGHT / FULLY UPHOLSTERED

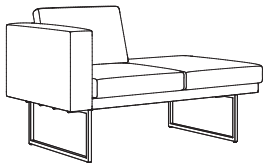

1019-SB

Overall: 49"w 29"d 30"h
Seat: 44"w 19.75"d 18"h

Arm: 26"h
Weight: tbd lbs.

COM: 4.75 yds.
COL: 85.5 sq.ft.

| COM | COL | 1 | 2 | 3 | 4 | 5 | 6 | 7 | 8 | 9 | 10 | L1 | L2 |
|------|------|------|------|------|------|------|------|------|------|------|------|------|------|
| 1767 | 1944 | 1918 | 2042 | 2166 | 2289 | 2413 | 2537 | 2661 | 2784 | 2908 | 3032 | 3182 | 3627 |

Tight Seat & Back / 500 lb. Weight Capacity

TWO PLACE TABLE-SEAT / ONE ARM RIGHT-TABLE LEFT

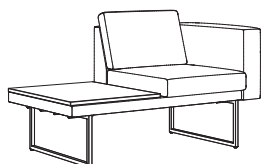

1020-TS

Overall: 49"w 29"d 30"h
Seat: 22"w 19.75"d 18"h

Arm: n/a
Weight: tbd lbs.

COM: 3.75 yds.
COL: 67.5 sq.ft.

| COM | COL | 1 | 2 | 3 | 4 | 5 | 6 | 7 | 8 | 9 | 10 | L1 | L2 |
|------|------|------|------|------|------|------|------|------|------|------|------|------|------|
| 1885 | 2073 | 1974 | 2071 | 2167 | 2263 | 2359 | 2455 | 2552 | 2648 | 2744 | 2840 | 2961 | 3307 |

High Pressure Laminate Top / Tight Seat & Back / 500 lb. Weight Capacity

DESCRIPTION:

- Upholstery Frames: Plywood
- Seat & Back: High Density Polyurethane Foam Over Plywood
- Legs: Standard Black Powdercoat Over Steel
(Optional Polished Stainless Steel Legs Available)
- Table: High Pressure Laminate Top
- 10 Year Warranty

OPTIONS:

- PSL-1 Polished Stainless Steel Legs\$594
(Replaces Standard Black Powdercoat Legs On Lounge Unit)
- PM1 Power/Data Module (1-Power / 1-USB 2 Port Simplex Charger)\$859
(Additional Power/Data Modules Available - See Savoie Options)

Feather Down & Polyester Pillows Available (See Page 5)
Tablet Arm / Cup Holder Options (See Savoie Options Pages)

LOUNGE

ITEM #: SPECIFICATIONS | GRADES | LIST PRICES:

TWO PLACE SEAT-TABLE / ONE ARM LEFT-TABLE RIGHT

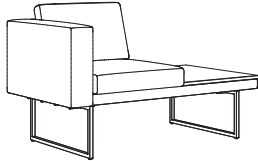

1021-ST

Overall: 49"w 29"d 30"h **Arm:** 26"h **COM:** 3.75 yds.
Seat: 22"w 19.75"d 18"h **Weight:** tbd lbs. **COL:** 67.5 sq.ft.

| COM | COL | 1 | 2 | 3 | 4 | 5 | 6 | 7 | 8 | 9 | 10 | L1 | L2 |
|-----|-----|---|---|---|---|---|---|---|---|---|----|----|----|
|-----|-----|---|---|---|---|---|---|---|---|---|----|----|----|

| | | | | | | | | | | | | | |
|------|------|------|------|------|------|------|------|------|------|------|------|------|------|
| 1885 | 2073 | 1974 | 2071 | 2167 | 2263 | 2359 | 2455 | 2552 | 2648 | 2744 | 2840 | 2961 | 3307 |
|------|------|------|------|------|------|------|------|------|------|------|------|------|------|

High Pressure Laminate Top / Tight Seat & Back / 500 lb. Weight Capacity

TWO PLACE SEAT-SEAT / ARMLESS / FULLY UPHOLSTERED

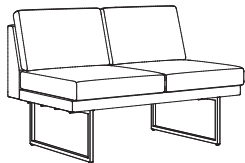

1022-SS

Overall: 44"w 29"d 30"h **Arm:** n/a **COM:** 5 yds.
Seat: 44"w 19.75"d 18"h **Weight:** tbd lbs. **COL:** 90 sq.ft.

| COM | COL | 1 | 2 | 3 | 4 | 5 | 6 | 7 | 8 | 9 | 10 | L1 | L2 |
|-----|-----|---|---|---|---|---|---|---|---|---|----|----|----|
|-----|-----|---|---|---|---|---|---|---|---|---|----|----|----|

| | | | | | | | | | | | | | |
|------|------|------|------|------|------|------|------|------|------|------|------|------|------|
| 1702 | 1872 | 1870 | 2001 | 2132 | 2262 | 2393 | 2523 | 2654 | 2784 | 2915 | 3046 | 3195 | 3666 |
|------|------|------|------|------|------|------|------|------|------|------|------|------|------|

Tight Seat & Back / 500 lb. Weight Capacity

TWO PLACE BENCH-SEAT / ARMLESS-BENCH LEFT / FULLY UPHOLSTERED

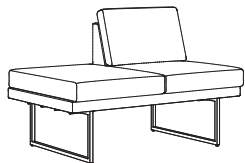

1023-BS

Overall: 44"w 29"d 30"h **Arm:** n/a **COM:** 4.5 yds.
Seat: 44"w 19.75"d 18"h **Weight:** tbd lbs. **COL:** 81 sq.ft.

| COM | COL | 1 | 2 | 3 | 4 | 5 | 6 | 7 | 8 | 9 | 10 | L1 | L2 |
|-----|-----|---|---|---|---|---|---|---|---|---|----|----|----|
|-----|-----|---|---|---|---|---|---|---|---|---|----|----|----|

| | | | | | | | | | | | | | |
|------|------|------|------|------|------|------|------|------|------|------|------|------|------|
| 1545 | 1700 | 1695 | 1811 | 1928 | 2045 | 2162 | 2279 | 2396 | 2512 | 2629 | 2746 | 2877 | 3298 |
|------|------|------|------|------|------|------|------|------|------|------|------|------|------|

Tight Seat & Back / 500 lb. Weight Capacity

TWO PLACE SEAT-BENCH / ARMLESS-BENCH RIGHT / FULLY UPHOLSTERED

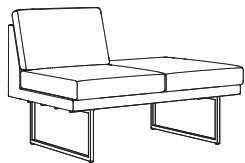

1024-SB

Overall: 44"w 29"d 30"h **Arm:** n/a **COM:** 4.5 yds.
Seat: 44"w 19.75"d 18"h **Weight:** tbd lbs. **COL:** 81 sq.ft.

| COM | COL | 1 | 2 | 3 | 4 | 5 | 6 | 7 | 8 | 9 | 10 | L1 | L2 |
|-----|-----|---|---|---|---|---|---|---|---|---|----|----|----|
|-----|-----|---|---|---|---|---|---|---|---|---|----|----|----|

| | | | | | | | | | | | | | |
|------|------|------|------|------|------|------|------|------|------|------|------|------|------|
| 1545 | 1700 | 1695 | 1811 | 1928 | 2045 | 2162 | 2279 | 2396 | 2512 | 2629 | 2746 | 2877 | 3298 |
|------|------|------|------|------|------|------|------|------|------|------|------|------|------|

Tight Seat & Back / 500 lb. Weight Capacity

TWO PLACE TABLE-SEAT / ARMLESS-TABLE LEFT

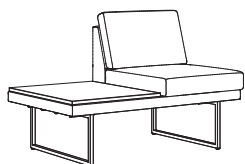

1025-TS

Overall: 44"w 29"d 30"h **Arm:** n/a **COM:** 3.5 yds.
Seat: 22"w 19.75"d 18"h **Weight:** tbd lbs. **COL:** 63 sq.ft.

| COM | COL | 1 | 2 | 3 | 4 | 5 | 6 | 7 | 8 | 9 | 10 | L1 | L2 |
|-----|-----|---|---|---|---|---|---|---|---|---|----|----|----|
|-----|-----|---|---|---|---|---|---|---|---|---|----|----|----|

| | | | | | | | | | | | | | |
|------|------|------|------|------|------|------|------|------|------|------|------|------|------|
| 1663 | 1829 | 1751 | 1840 | 1929 | 2019 | 2108 | 2197 | 2287 | 2376 | 2465 | 2555 | 2656 | 2978 |
|------|------|------|------|------|------|------|------|------|------|------|------|------|------|

High Pressure Laminate Top / Tight Seat & Back / 500 lb. Weight Capacity

DESCRIPTION:

- Upholstery Frames: Plywood
- Seat & Back: High Density Polyurethane Foam Over Plywood
- Legs: Standard Black Powdercoat Over Steel
(Optional Polished Stainless Steel Legs Available)
- Table: High Pressure Laminate Top
- 10 Year Warranty

OPTIONS:

- PSL-1 Polished Stainless Steel Legs\$594
(Replaces Standard Black Powdercoat Legs On Lounge Unit)
- PM1 Power/Data Module (1-Power / 1-USB 2 Port Simplex Charger)\$859
(Additional Power/Data Modules Available - See Savoie Options)

Feather Down & Polyester Pillows Available (See Page 5)
Tablet Arm / Cup Holder Options (See Savoie Options Pages)

LOUNGE

ITEM #: SPECIFICATIONS | GRADES | LIST PRICES:

**TWO PLACE SEAT-TABLE /
ARMLESS-TABLE RIGHT**

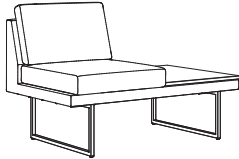

1026-ST

Overall: 44"w 29"d 30"h **Arm:** n/a **COM:** 3.5 yds.
Seat: 22"w 19.75"d 18"h **Weight:** tbd lbs. **COL:** 63 sq.ft.

| COM | COL | 1 | 2 | 3 | 4 | 5 | 6 | 7 | 8 | 9 | 10 | L1 | L2 |
|------|------|------|------|------|------|------|------|------|------|------|------|------|------|
| 1663 | 1829 | 1751 | 1840 | 1929 | 2019 | 2108 | 2197 | 2287 | 2376 | 2465 | 2555 | 2656 | 2978 |

High Pressure Laminate Top / Tight Seat & Back / 500 lb. Weight Capacity

**TWO PLACE BENCH-BENCH /
FULLY UPHOLSTERED**

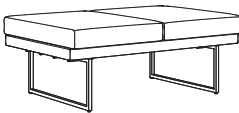

1027-BB

Overall: 44"w 29"d 18"h **Arm:** n/a **COM:** 3.25 yds.
Seat: 44"w 29"d 18"h **Weight:** tbd lbs. **COL:** 58.5 sq.ft.

| COM | COL | 1 | 2 | 3 | 4 | 5 | 6 | 7 | 8 | 9 | 10 | L1 | L2 |
|------|------|------|------|------|------|------|------|------|------|------|------|------|------|
| 1359 | 1495 | 1450 | 1533 | 1615 | 1697 | 1780 | 1862 | 1945 | 2027 | 2110 | 2192 | 2290 | 2587 |

Tight Seat & Back / 500 lb. Weight Capacity

TWO PLACE BENCH-TABLE

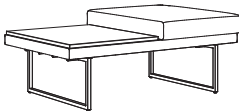

1028-BT

Overall: 44"w 29"d 18"h **Arm:** n/a **COM:** 2.25 yds.
Seat: 22"w 29"d 18"h **Weight:** tbd lbs. **COL:** 40.5 sq.ft.

| COM | COL | 1 | 2 | 3 | 4 | 5 | 6 | 7 | 8 | 9 | 10 | L1 | L2 |
|------|------|------|------|------|------|------|------|------|------|------|------|------|------|
| 1471 | 1618 | 1501 | 1556 | 1610 | 1665 | 1720 | 1775 | 1830 | 1885 | 1940 | 1995 | 2064 | 2262 |

High Pressure Laminate Top / Tight Seat / 500 lb. Weight Capacity

**THREE PLACE SEAT-SEAT-SEAT /
ARMS LEFT & RIGHT / FULLY UPHOLSTERED**

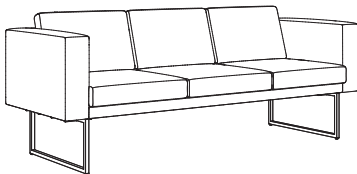

1030-SSS

Overall: 76"w 29"d 30"h **Arm:** 26"h **COM:** 9.25 yds.
Seat: 66"w 19.75"d 18"h **Weight:** tbd lbs. **COL:** 166.5 sq.ft.

| COM | COL | 1 | 2 | 3 | 4 | 5 | 6 | 7 | 8 | 9 | 10 | L1 | L2 |
|------|------|------|------|------|------|------|------|------|------|------|------|------|------|
| 2688 | 2956 | 3036 | 3283 | 3531 | 3778 | 4026 | 4273 | 4520 | 4768 | 5015 | 5263 | 5452 | 6343 |

Tight Seat & Back / 500 lb. Weight Capacity

**THREE PLACE SEAT-TABLE-SEAT /
ARMS LEFT & RIGHT-TABLE CENTER**

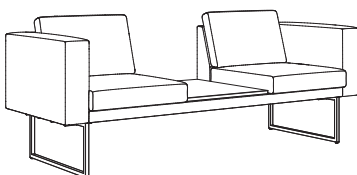

1031-STS

Overall: 76"w 29"d 30"h **Arm:** 26"h **COM:** 8 yds.
Seat: 66"w 19.75"d 18"h **Weight:** tbd lbs. **COL:** 144 sq.ft.

| COM | COL | 1 | 2 | 3 | 4 | 5 | 6 | 7 | 8 | 9 | 10 | L1 | L2 |
|------|------|------|------|------|------|------|------|------|------|------|------|------|------|
| 2562 | 2818 | 2849 | 3062 | 3275 | 3488 | 3701 | 3914 | 4127 | 4340 | 4553 | 4766 | 5004 | 5771 |

High Pressure Laminate Top / Tight Seat & Back / 500 lb. Weight Capacity

DESCRIPTION:

- Upholstery Frames: Plywood
- Seat & Back: High Density Polyurethane Foam Over Plywood
- Legs: Standard Black Powdercoat Over Steel (Optional Polished Stainless Steel Legs Available)
- Table: High Pressure Laminate Top
- 10 Year Warranty

OPTIONS:

- PSL-1 Polished Stainless Steel Legs\$594 (Replaces Standard Black Powdercoat Legs On Lounge Unit)
- PM1 Power/Data Module (1-Power / 1-USB 2 Port Simplex Charger)\$859 (Additional Power/Data Modules Available - See Savoie Options)

Feather Down & Polyester Pillows Available (See Page 5)
 Tablet Arm / Cup Holder Options (See Savoie Options Pages)

LOUNGE

ITEM #: SPECIFICATIONS | GRADES | LIST PRICES:

THREE PLACE SEAT-SEAT-SEAT / ONE ARM LEFT / FULLY UPHOLSTERED

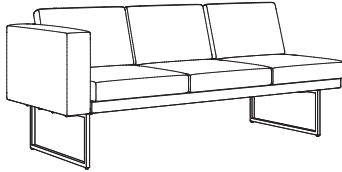

1032-SSS

Overall: 71"w 29"d 30"h **Arm:** 26"h **COM:** 8.5 yds.
Seat: 66"w 19.75"d 18"h **Weight:** tbd lbs. **COL:** 153 sq.ft.

| COM | COL | 1 | 2 | 3 | 4 | 5 | 6 | 7 | 8 | 9 | 10 | L1 | L2 |
|------|------|------|------|------|------|------|------|------|------|------|------|------|------|
| 2395 | 2635 | 2718 | 2945 | 3172 | 3398 | 3625 | 3852 | 4079 | 4306 | 4532 | 4759 | 5018 | 5834 |

Tight Seat & Back / 500 lb. Weight Capacity

THREE PLACE SEAT-SEAT-SEAT / ONE ARM RIGHT / FULLY UPHOLSTERED

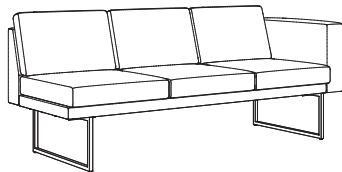

1033-SSS

Overall: 71"w 29"d 30"h **Arm:** 26"h **COM:** 8.5 yds.
Seat: 66"w 19.75"d 18"h **Weight:** tbd lbs. **COL:** 153 sq.ft.

| COM | COL | 1 | 2 | 3 | 4 | 5 | 6 | 7 | 8 | 9 | 10 | L1 | L2 |
|------|------|------|------|------|------|------|------|------|------|------|------|------|------|
| 2395 | 2635 | 2718 | 2945 | 3172 | 3398 | 3625 | 3852 | 4079 | 4306 | 4532 | 4759 | 5018 | 5834 |

Tight Seat & Back / 500 lb. Weight Capacity

THREE PLACE SEAT-TABLE-SEAT / ONE ARM LEFT-TABLE CENTER

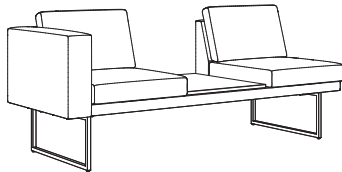

1034-ST5

Overall: 71"w 29"d 30"h **Arm:** 26"h **COM:** 7 yds.
Seat: 44"w 19.75"d 18"h **Weight:** tbd lbs. **COL:** 126 sq.ft.

| COM | COL | 1 | 2 | 3 | 4 | 5 | 6 | 7 | 8 | 9 | 10 | L1 | L2 |
|------|------|------|------|------|------|------|------|------|------|------|------|------|------|
| 2373 | 2610 | 2615 | 2800 | 2986 | 3171 | 3357 | 3542 | 3728 | 3914 | 4099 | 4285 | 4495 | 4495 |

High Pressure Laminate Top / Tight Seat & Back / 500 lb. Weight Capacity

THREE PLACE SEAT-TABLE-SEAT / ONE ARM RIGHT-TABLE CENTER

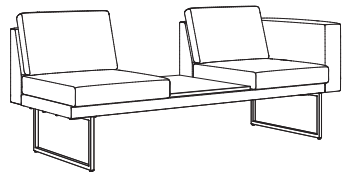

1035-ST5

Overall: 71"w 29"d 30"h **Arm:** 26"h **COM:** 7 yds.
Seat: 44"w 19.75"d 18"h **Weight:** tbd lbs. **COL:** 126 sq.ft.

| COM | COL | 1 | 2 | 3 | 4 | 5 | 6 | 7 | 8 | 9 | 10 | L1 | L2 |
|------|------|------|------|------|------|------|------|------|------|------|------|------|------|
| 2373 | 2610 | 2615 | 2800 | 2986 | 3171 | 3357 | 3542 | 3728 | 3914 | 4099 | 4285 | 4495 | 4495 |

High Pressure Laminate Top / Tight Seat & Back / 500 lb. Weight Capacity

THREE PLACE BENCH-SEAT-SEAT / ONE ARM RIGHT-BENCH LEFT / FULLY UPHOLSTERED

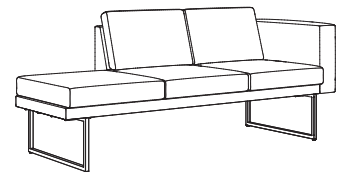

1036-BSS

Overall: 71"w 29"d 30"h **Arm:** 26"h **COM:** 8 yds.
Seat: 66"w 19.75"d 18"h **Weight:** tbd lbs. **COL:** 144 sq.ft.

| COM | COL | 1 | 2 | 3 | 4 | 5 | 6 | 7 | 8 | 9 | 10 | L1 | L2 |
|------|------|------|------|------|------|------|------|------|------|------|------|------|------|
| 2232 | 2456 | 2537 | 2750 | 2963 | 3176 | 3389 | 3602 | 3815 | 4028 | 4241 | 4454 | 4694 | 5461 |

Tight Seat & Back / 500 lb. Weight Capacity

DESCRIPTION:

- Upholstery Frames: Plywood
- Seat & Back: High Density Polyurethane Foam Over Plywood
- Legs: Standard Black Powdercoat Over Steel
(Optional Polished Stainless Steel Legs Available)
- Table: High Pressure Laminate Top
- 10 Year Warranty

OPTIONS:

- PSL-1 Polished Stainless Steel Legs\$594
(Replaces Standard Black Powdercoat Legs On Lounge Unit)
- PM1 Power/Data Module (1-Power / 1-USB 2 Port Simplex Charger)\$859
(Additional Power/Data Modules Available - See Savoie Options)

Feather Down & Polyester Pillows Available (See Page 5)
Tablet Arm / Cup Holder Options (See Savoie Options Pages)

LOUNGE

ITEM #: SPECIFICATIONS | GRADES | LIST PRICES:

THREE PLACE SEAT-SEAT-BENCH / ONE ARM LEFT-BENCH RIGHT / FULLY UPHOLSTERED

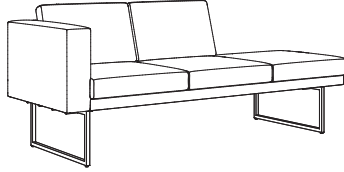

1037-SSB

Overall: 71"w 29"d 30"h **Arm:** 26"h **COM:** 8 yds.
Seat: 66"w 19.75"d 18"h **Weight:** tbd lbs. **COL:** 144 sq.ft.

| COM | COL | 1 | 2 | 3 | 4 | 5 | 6 | 7 | 8 | 9 | 10 | L1 | L2 |
|------|------|------|------|------|------|------|------|------|------|------|------|------|------|
| 2232 | 2456 | 2537 | 2750 | 2963 | 3176 | 3389 | 3602 | 3815 | 4028 | 4241 | 4454 | 4694 | 5461 |

Tight Seat & Back / 500 lb. Weight Capacity

THREE PLACE TABLE-SEAT-SEAT / ONE ARM RIGHT-TABLE LEFT

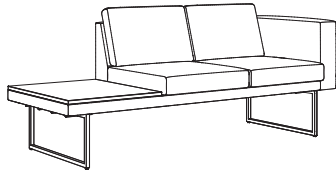

1038-TSS

Overall: 71"w 29"d 30"h **Arm:** 26"h **COM:** 7 yds.
Seat: 44"w 19.75"d 18"h **Weight:** tbd lbs. **COL:** 126 sq.ft.

| COM | COL | 1 | 2 | 3 | 4 | 5 | 6 | 7 | 8 | 9 | 10 | L1 | L2 |
|------|------|------|------|------|------|------|------|------|------|------|------|------|------|
| 2379 | 2617 | 2620 | 2806 | 2991 | 3177 | 3362 | 3548 | 3733 | 3919 | 4105 | 4290 | 4501 | 5169 |

High Pressure Laminate Top / Tight Seat & Back / 500 lb. Weight Capacity

THREE PLACE SEAT-SEAT-TABLE / ONE ARM LEFT-TABLE RIGHT

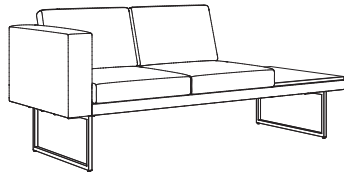

1039-SST

Overall: 71"w 29"d 30"h **Arm:** 26"h **COM:** 7 yds.
Seat: 44"w 19.75"d 18"h **Weight:** tbd lbs. **COL:** 126 sq.ft.

| COM | COL | 1 | 2 | 3 | 4 | 5 | 6 | 7 | 8 | 9 | 10 | L1 | L2 |
|------|------|------|------|------|------|------|------|------|------|------|------|------|------|
| 2379 | 2617 | 2620 | 2806 | 2991 | 3177 | 3362 | 3548 | 3733 | 3919 | 4105 | 4290 | 4501 | 5169 |

High Pressure Laminate Top / Tight Seat & Back / 500 lb. Weight Capacity

THREE PLACE SEAT-SEAT-SEAT / ARMLESS / FULLY UPHOLSTERED

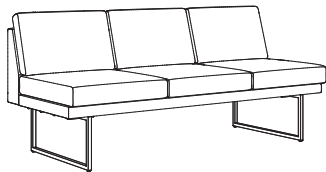

1040-SSS

Overall: 66"w 29"d 30"h **Arm:** n/a **COM:** 7.25 yds.
Seat: 66"w 19.75"d 18"h **Weight:** tbd lbs. **COL:** 130.5 sq.ft.

| COM | COL | 1 | 2 | 3 | 4 | 5 | 6 | 7 | 8 | 9 | 10 | L1 | L2 |
|------|------|------|------|------|------|------|------|------|------|------|------|------|------|
| 2222 | 2444 | 2485 | 2678 | 2870 | 3063 | 3255 | 3448 | 3640 | 3832 | 4025 | 4217 | 4435 | 5128 |

Tight Seat & Back / 500 lb. Weight Capacity

THREE PLACE BENCH-SEAT-SEAT / ARMLESS-BENCH LEFT / FULLY UPHOLSTERED

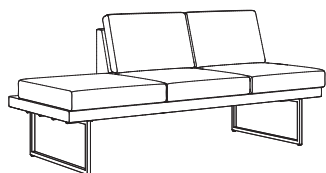

1041-BSS

Overall: 66"w 29"d 30"h **Arm:** n/a **COM:** 7 yds.
Seat: 66"w 19.75"d 18"h **Weight:** tbd lbs. **COL:** 126 sq.ft.

| COM | COL | 1 | 2 | 3 | 4 | 5 | 6 | 7 | 8 | 9 | 10 | L1 | L2 |
|------|------|------|------|------|------|------|------|------|------|------|------|------|------|
| 2010 | 2211 | 2272 | 2457 | 2643 | 2828 | 3014 | 3199 | 3385 | 3571 | 3756 | 3942 | 4149 | 4817 |

Tight Seat & Back / 500 lb. Weight Capacity

DESCRIPTION:

- Upholstery Frames: Plywood
- Seat & Back: High Density Polyurethane Foam Over Plywood
- Legs: Standard Black Powdercoat Over Steel
(Optional Polished Stainless Steel Legs Available)
- Table: High Pressure Laminate Top
- 10 Year Warranty

OPTIONS:

- PSL-1 Polished Stainless Steel Legs\$594
(Replaces Standard Black Powdercoat Legs On Lounge Unit)
- PM1 Power/Data Module (1-Power / 1-USB 2 Port Simplex Charger)\$859
(Additional Power/Data Modules Available - See Savoie Options)

Feather Down & Polyester Pillows Available (See Page 5)
Tablet Arm / Cup Holder Options (See Savoie Options Pages)

LOUNGE

ITEM #: SPECIFICATIONS | GRADES | LIST PRICES:

**THREE PLACE SEAT-SEAT-BENCH /
ARMLESS-BENCH RIGHT / FULLY UPHOLSTERED**

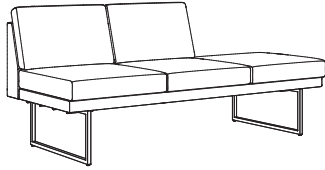

1042-SSB

Overall: 66"w 29"d 30"h **Arm:** n/a **COM:** 7 yds.
Seat: 66"w 19.75"d 18"h **Weight:** tbd lbs. **COL:** 126 sq.ft.

| COM | COL | 1 | 2 | 3 | 4 | 5 | 6 | 7 | 8 | 9 | 10 | L1 | L2 |
|------|------|------|------|------|------|------|------|------|------|------|------|------|------|
| 2010 | 2211 | 2272 | 2457 | 2643 | 2828 | 3014 | 3199 | 3385 | 3571 | 3756 | 3942 | 4149 | 4817 |

Tight Seat & Back / 500 lb. Weight Capacity

**THREE PLACE TABLE-SEAT-SEAT /
ARMLESS-TABLE LEFT**

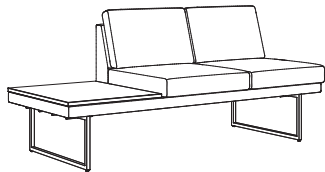

1043-TSS

Overall: 66"w 29"d 30"h **Arm:** n/a **COM:** 6 yds.
Seat: 44"w 19.75"d 18"h **Weight:** tbd lbs. **COL:** 108 sq.ft.

| COM | COL | 1 | 2 | 3 | 4 | 5 | 6 | 7 | 8 | 9 | 10 | L1 | L2 |
|------|------|------|------|------|------|------|------|------|------|------|------|------|------|
| 2128 | 2340 | 2328 | 2486 | 2644 | 2802 | 2960 | 3118 | 3276 | 3434 | 3592 | 3750 | 3928 | 4497 |

High Pressure Laminate Top / Tight Seat & Back / 500 lb. Weight Capacity

**THREE PLACE SEAT-SEAT-TABLE /
ARMLESS-TABLE RIGHT**

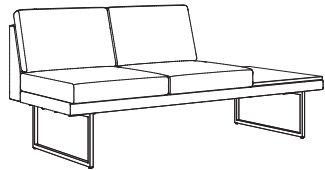

1044-SST

Overall: 66"w 29"d 30"h **Arm:** n/a **COM:** 6 yds.
Seat: 44"w 19.75"d 18"h **Weight:** tbd lbs. **COL:** 108 sq.ft.

| COM | COL | 1 | 2 | 3 | 4 | 5 | 6 | 7 | 8 | 9 | 10 | L1 | L2 |
|------|------|------|------|------|------|------|------|------|------|------|------|------|------|
| 2128 | 2340 | 2328 | 2486 | 2644 | 2802 | 2960 | 3118 | 3276 | 3434 | 3592 | 3750 | 3928 | 4497 |

High Pressure Laminate Top / Tight Seat & Back / 500 lb. Weight Capacity

**THREE PLACE SEAT-TABLE-SEAT /
ARMLESS-TABLE CENTER**

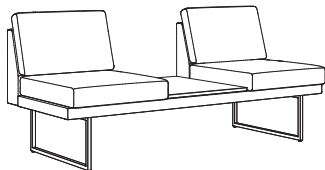

1045-ST5

Overall: 66"w 29"d 30"h **Arm:** n/a **COM:** 6 yds.
Seat: 44"w 19.75"d 18"h **Weight:** tbd lbs. **COL:** 108 sq.ft.

| COM | COL | 1 | 2 | 3 | 4 | 5 | 6 | 7 | 8 | 9 | 10 | L1 | L2 |
|------|------|------|------|------|------|------|------|------|------|------|------|------|------|
| 2151 | 2366 | 2350 | 2508 | 2666 | 2824 | 2982 | 3140 | 3298 | 3456 | 3614 | 3772 | 3950 | 4519 |

High Pressure Laminate / Tight Seat & Back / 500 lb. Weight Capacity

**THREE PLACE BENCH-BENCH-BENCH /
FULLY UPHOLSTERED**

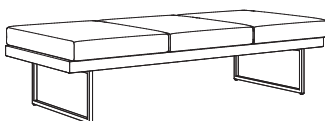

1046-BBB

Overall: 66"w 29"d 18"h **Arm:** n/a **COM:** 4.75 yds.
Seat: 66"w 29"d 18"h **Weight:** tbd lbs. **COL:** 85.5 sq.ft.

| COM | COL | 1 | 2 | 3 | 4 | 5 | 6 | 7 | 8 | 9 | 10 | L1 | L2 |
|------|------|------|------|------|------|------|------|------|------|------|------|------|------|
| 1622 | 1784 | 1781 | 1905 | 2028 | 2152 | 2276 | 2399 | 2523 | 2647 | 2770 | 2894 | 3030 | 3475 |

Tight Seat / 500 lb. Weight Capacity

DESCRIPTION:

- Upholstery Frames: Plywood
- Seat & Back: High Density Polyurethane Foam Over Plywood
- Legs: Standard Black Powdercoat Over Steel
(Optional Polished Stainless Steel Legs Available)
- Table: High Pressure Laminate Top
- 10 Year Warranty

OPTIONS:

- PSL-1 Polished Stainless Steel Legs\$594
(Replaces Standard Black Powdercoat Legs On Lounge Unit)
- PSL-2 Polished Stainless Steel Legs\$902
(Replaces Standard Black Powdercoat Legs On End Table)
- PSL-3 Polished Stainless Steel Legs\$1092
(Replaces Standard Black Powdercoat Legs On Coffee Table)
- PM1 Power/Data Module (1-Power / 1-USB 2 Port Simplex Charger)\$859
(Additional Power/Data Modules Available - See Savoie Options)
- Tablet Arm / Cup Holder Options (See Savoie Options Pages)

LOUNGE / TABLES

ITEM #: SPECIFICATIONS | GRADES | LIST PRICES:

THREE PLACE BENCH-BENCH-TABLE / TABLE RIGHT

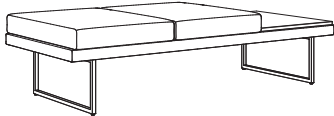

1047-BBT

Overall: 66"w 29"d 18"h
Seat: 44"w 29"d 18"h

Arm: n/a
Weight: tbd lbs.

COM: 3.75 yds.
COL: 67.5 sq.ft.

| COM | COL | 1 | 2 | 3 | 4 | 5 | 6 | 7 | 8 | 9 | 10 | L1 | L2 |
|------|------|------|------|------|------|------|------|------|------|------|------|------|------|
| 1791 | 1970 | 1885 | 1981 | 2078 | 2174 | 2270 | 2366 | 2463 | 2559 | 2655 | 2751 | 2867 | 3214 |

High Pressure Laminate Top / Tight Seat / 500 lb. Weight Capacity

THREE PLACE BENCH-TABLE-BENCH / TABLE CENTER

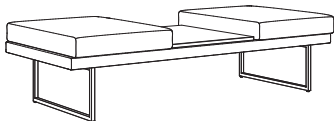

1048-BTB

Overall: 66"w 29"d 18"h
Seat: 44"w 29"d 18"h

Arm: n/a
Weight: tbd lbs.

COM: 3.75 yds.
COL: 67.5 sq.ft.

| COM | COL | 1 | 2 | 3 | 4 | 5 | 6 | 7 | 8 | 9 | 10 | L1 | L2 |
|------|------|------|------|------|------|------|------|------|------|------|------|------|------|
| 1791 | 1970 | 1885 | 1981 | 2078 | 2174 | 2270 | 2366 | 2463 | 2559 | 2655 | 2751 | 2867 | 3214 |

High Pressure Laminate Top / Tight Seat / 500 lb. Weight Capacity

END TABLE

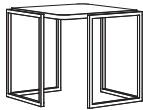

102020-L

102020-C

Overall: 20"w 20"d 20"h

Weight: 38 lbs.

| COM | COL | 1 | 2 | 3 | 4 | 5 | 6 | 7 | 8 | 9 | 10 | L1 | L2 |
|------|-----|---|---|---|---|---|---|---|---|---|----|----|----|
| 1058 | | | | | | | | | | | | | |
| 1123 | | | | | | | | | | | | | |

High Pressure Laminate Top
Solid Surface Top

COFFEE TABLE

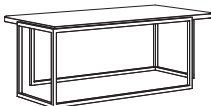

102242-L

102242-C





Overall: 22"w 42"d 16"h

Weight: 52 lbs.

| COM | COL | 1 | 2 | 3 | 4 | 5 | 6 | 7 | 8 | 9 | 10 | L1 | L2 |
|------|-----|---|---|---|---|---|---|---|---|---|----|----|----|
| 1621 | | | | | | | | | | | | | |
| 2008 | | | | | | | | | | | | | |

High Pressure Laminate Top
Solid Surface Top

| LEGS / TABLET ARMS | OPTION #: | SPECIFICATIONS LIST PRICES AVAILABILITY: |
|---|---|--|
| <p>POLISHED STAINLESS STEEL LEGS</p> <p><i>Overall: n/a</i></p> | | |
|  <p>PSL-1</p>  <p>PSL-2</p>  <p>PSL-3</p> | <p>PSL-1 \$594 <i>Replaces Standard Black Powdercoat Legs On Lounge Unit With Polished Stainless Steel Legs.</i></p> <p>PSL-2 \$902 <i>Replaces Standard Black Powdercoat Legs On End Table With Polished Stainless Steel Legs.</i></p> <p>PSL-3 \$1092 <i>Replaces Standard Black Powdercoat Legs On Coffee Table With Polished Stainless Steel Legs.</i></p> <p>Available: Savoie Collection</p> | |
| <p>TABLET ARMS / CUP HOLDER</p> <p><i>Overall: 14" Diameter .75"h</i></p> | | |
|  <p>Laminate Tablet Arm Shown w/ Cup Holder</p>  <p>Veneer Tablet Arm Shown w/ Cup Holder</p>  <p>Solid Surface Tablet Arm Shown w/ Cup Holder</p> | <p>TA-L \$509 <i>Tablet Arm With 360° Rotation - High Pressure Laminate. (Specify Laminate / Specify Left Or Right Facing Arm Location)</i></p> <p>TA-V \$580 <i>Tablet Arm With 360° Rotation - Sunburst Cherry Veneer. (Specify Finish / Specify Left Or Right Facing Arm Location)</i></p> <p>TA-C \$698 <i>Tablet Arm With 360° Rotation - White Solid Surface. (Available In White Only / Specify Left Or Right Facing Arm Location)</i></p> <p>CH-1 \$129 <i>Black Plastic Cup Holder (Only Available If Used With Tablet Arm)</i></p> <p>CH-2 \$186 <i>Spun Aluminum Cup Holder (Only Available If Used With Tablet Arm)</i></p> <p>Available: Savoie Lounge</p> | |
| <p>FOLD DOWN TABLET ARM</p> <p><i>Overall: 14" Diameter .75"h</i></p> | | |
|    | <p>FDTA-L \$1065 <i>Tablet Arm With 360° Rotation - High Pressure Laminate. (Specify Laminate / Specify Left Or Right Facing Arm Location)</i></p> <p>FDTA-V \$1136 <i>Tablet Arm With 360° Rotation - Sunburst Cherry Veneer. (Specify Finish / Specify Left Or Right Facing Arm Location)</i></p> <p>FDTA-C \$1278 <i>Tablet Arm With 360° Rotation - White Solid Surface. (Available In White Only / Specify Left Or Right Facing Arm Location)</i></p> <p>Available: Savoie Lounge</p> | |

| POWER / COVERS | OPTION #: | SPECIFICATIONS LIST PRICES AVAILABILITY: |
|--|---|---|
| <p>POWER / DATA MODULE</p>  <p>PM1 Power / Data Module</p>  <p>PM2 Power Module</p>  <p>USB-1 Dual Charging USB</p> | <p>PM1</p> <p>PM2</p> <p>USB-1</p> | <p>PM1 Overall: 5.25"w 1.25"d 4.25"h PM2 Overall: 2"w 2"d .125"h USB-1 Overall: 2"w 2"d .125"h</p> <p>\$859 Power/Data Module (1-Power / 1-USB 2 Port Simplex Charger Standard) <i>Vertical / Horizontal Mount Power Module. Price Varies By Socket. Contact Customer Service For Quote. (Additional Colors Available)</i></p> <p>\$238 Power Module (1-Power) <i>Spill-Proof Technology / Multiple Finish Options / Storm Color Standard (Specify Left or Right Facing)</i></p> <p>\$238 Dual Charging USB (2 Port Simplex Charger Standard) <i>Spill-Proof Technology / 2 Amps Per Port / Multiple Finish Options / Storm Color Standard (Specify Left or Right Facing)</i></p> <p>Available: Savoie Collection</p> |
| <p>CONTRASTING COVERS</p>  | <p>CC</p> | <p>Overall: n/a</p> <p>\$129 <i>NOTE: If Two Or More Upholsteries Or Leathers Are Used On Any Piece Of Furniture, Then A Contrast Charge Will Apply Per Order. When Using Trinity Upholstery, The Higher Priced Upholstery Grade Will Be Used In Pricing, Unless It's Trinity Leather With Fabric Contrast Welt, Or COM With Trinity Contrast Welt, Then Contact Customer Service For Pricing.</i></p> <p>Available: Savoie Collection</p> |

Ace

WALLSAVER RECLINER

Effective: March 1, 2025

T R I N I T Y

Date:

Page:

Modification:

Description:

DESCRIPTION:

- Upholstery Frames: Steel, Plywood & Hardwood
- Removable Seat: High Density Polyurethane Foam Over Sheet Webbing
- Back: High Density Polyurethane Foam Over Contoured Curved Plywood Back
- Upholstered Covers On Seat & Back: Attached w/ Velcro / Removable For Maintenance
- Antimicrobial Moisture Barrier Fully Encapsulates All Foam Areas On Seat & Back
- Manual Side Lever Footrest Control
- Double Needle Stitching Standard
- Leather Upholstery Available
- 10 Year Warranty

OPTIONS:

- SSAC Solid Surface Arm Caps (Set Of 2) \$732
 - PAC Polyester Arm Caps (Set Of 2) \$305
 - USB-1 Dual Charging USB \$238
 - PDM Power/Data Module \$859
 - HM Heat & Massage (Back Only) \$1403
 - H Heat \$1023
 - NRS Non-Removable Seat \$50
- Feather Down & Polyester Pillows Available (See Page 5)
Specify Exposed Wood Finish (See Page 6)

WALLSAVER

ITEM #:

SPECIFICATIONS | GRADES | LIST PRICES:

WALLSAVER RECLINER / TAPERED WOODEN LEGS / FULLY UPHOLSTERED

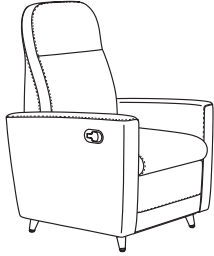

Healthcare Motion

Overall: 29"w 33"d 46.5"h **Arm:** 27"h **COM:** 5.5 yds.
Seat: 21"w 21.5"d 19.5"h **Weight:** 120 lbs. **COL:** 99 sq.ft.

| COM | COL | 1 | 2 | 3 | 4 | 5 | 6 | 7 | 8 | 9 | 10 | L1 | L2 |
|------|------|------|------|------|------|------|------|------|------|------|------|------|------|
| 2308 | 2539 | 2442 | 2571 | 2701 | 2831 | 2960 | 3090 | 3219 | 3349 | 3479 | 3608 | 3764 | 4231 |

Tight Seat & Back / Removable Seat & Back Upholstery / 7" Wall Proximity / 350 lb. Weight Capacity

1055-A

WALLSAVER RECLINER / 360° SWIVEL BASE / FULLY UPHOLSTERED

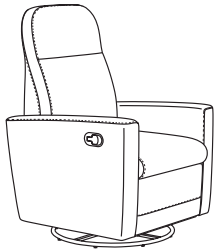

Healthcare Motion

Overall: 29"w 33"d 46.5"h **Arm:** 27"h **COM:** 5.5 yds.
Seat: 21"w 21.5"d 18"h **Weight:** 120 lbs. **COL:** 99 sq.ft.

| COM | COL | 1 | 2 | 3 | 4 | 5 | 6 | 7 | 8 | 9 | 10 | L1 | L2 |
|------|------|------|------|------|------|------|------|------|------|------|------|------|------|
| 2371 | 2608 | 2501 | 2631 | 2760 | 2890 | 3020 | 3149 | 3279 | 3409 | 3538 | 3668 | 3824 | 4290 |

Tight Seat & Back / Removable Seat & Back Upholstery / 7" Wall Proximity / 350 lb. Weight Capacity

1055-B

WALLSAVER RECLINER / CASTERS / FULLY UPHOLSTERED

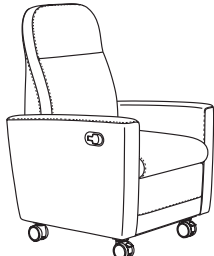

Healthcare Motion

Overall: 29"w 33"d 46.5"h **Arm:** 27"h **COM:** 5.5 yds.
Seat: 21"w 21.5"d 19.5"h **Weight:** 120 lbs. **COL:** 99 sq.ft.

| COM | COL | 1 | 2 | 3 | 4 | 5 | 6 | 7 | 8 | 9 | 10 | L1 | L2 |
|------|------|------|------|------|------|------|------|------|------|------|------|------|------|
| 2272 | 2499 | 2407 | 2537 | 2666 | 2796 | 2925 | 3055 | 3185 | 3314 | 3444 | 3573 | 3730 | 4196 |

Tight Seat & Back / Removable Seat & Back Upholstery / 7" Wall Proximity / 350 lb. Weight Capacity

1055-C

Swivel & Locking Casters (Front)
Non-Swivel & Non-Locking Casters (Rear)

WALLSAVER RECLINER / TAPERED BRUSHED ALUMINUM LEGS / FULLY UPHOLSTERED

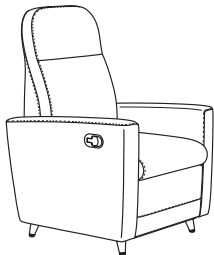

Healthcare Motion

Overall: 29"w 33"d 46.5"h **Arm:** 27"h **COM:** 5.5 yds.
Seat: 21"w 21.5"d 19.5"h **Weight:** 120 lbs. **COL:** 99 sq.ft.

| COM | COL | 1 | 2 | 3 | 4 | 5 | 6 | 7 | 8 | 9 | 10 | L1 | L2 |
|------|------|------|------|------|------|------|------|------|------|------|------|------|------|
| 2446 | 2691 | 2572 | 2701 | 2831 | 2961 | 3090 | 3220 | 3350 | 3479 | 3609 | 3738 | 3895 | 4361 |

Tight Seat & Back / Removable Seat & Back Upholstery / 7" Wall Proximity / 350 lb. Weight Capacity

1055-D

DESCRIPTION:

- Upholstery Frames: Steel, Plywood & Hardwood
- Removable Seat: High Density Polyurethane Foam Over Sheet Webbing
- Back: High Density Polyurethane Foam Over Contoured Curved Plywood Back
- Upholstered Covers On Seat & Back: Attached w/ Velcro / Removable For Maintenance
- Antimicrobial Moisture Barrier Fully Encapsulates All Foam Areas On Seat & Back
- Three Position Recline (Weight Activated)
- Double Needle Stitching Standard
- Leather Upholstery Available
- 10 Year Warranty

OPTIONS:

- SSAC Solid Surface Arm Caps (Set Of 2)\$732
 - PAC Polyester Arm Caps (Set Of 2)\$305
 - USB-1 Dual Charging USB\$238
 - PDM Power/Data Module\$859
 - HM Heat & Massage (Back Only)\$1403
 - H Heat\$1023
 - NRS Non-Removable Seat\$50
- Feather Down & Polyester Pillows Available (See Page 5)
Specify Exposed Wood Finish (See Page 6)

THREE POSITION RECLINE

ITEM #:

SPECIFICATIONS | GRADES | LIST PRICES:

THREE POSITION RECLINER / TAPERED WOODEN LEGS / FULLY UPHOLSTERED

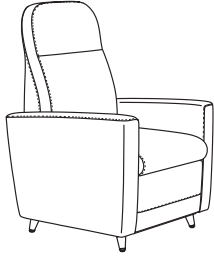

Healthcare Motion

Overall: 29"w 33"d 46.5"h **Arm:** 27"h **COM:** 7.5 yds.
Seat: 21"w 21.5"d 19.5"h **Weight:** 120 lbs. **COL:** 135 sq.ft.

| COM | COL | 1 | 2 | 3 | 4 | 5 | 6 | 7 | 8 | 9 | 10 | L1 | L2 |
|------|------|------|------|------|------|------|------|------|------|------|------|------|------|
| 2465 | 2712 | 2688 | 2868 | 3049 | 3229 | 3409 | 3589 | 3769 | 3949 | 4129 | 4309 | 4506 | 5154 |

Tight Seat & Back / Removable Seat & Back Upholstery / Three Position Mechanism / 600 lb. Weight Capacity

1056-A

THREE POSITION RECLINER / CASTERS / FULLY UPHOLSTERED



Healthcare Motion

Overall: 29"w 33"d 46.5"h **Arm:** 27"h **COM:** 7.5 yds.
Seat: 21"w 21.5"d 19.5"h **Weight:** 120 lbs. **COL:** 135 sq.ft.

| COM | COL | 1 | 2 | 3 | 4 | 5 | 6 | 7 | 8 | 9 | 10 | L1 | L2 |
|------|------|------|------|------|------|------|------|------|------|------|------|------|------|
| 2491 | 2740 | 2712 | 2892 | 3073 | 3253 | 3433 | 3613 | 3793 | 3973 | 4153 | 4333 | 4530 | 5178 |

Tight Seat & Back / Removable Seat & Back Upholstery / Three Position Mechanism / 600 lb. Weight Capacity

1056-C

Swivel & Locking Casters (Front)
Non-Swivel & Non-Locking Casters (Rear)

THREE POSITION RECLINER / TAPERED BRUSHED ALUMINUM LEGS / FULLY UPHOLSTERED

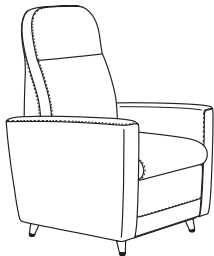

Healthcare Motion

Overall: 29"w 33"d 46.5"h **Arm:** 27"h **COM:** 7.5 yds.
Seat: 21"w 21.5"d 19.5"h **Weight:** 120 lbs. **COL:** 135 sq.ft.

| COM | COL | 1 | 2 | 3 | 4 | 5 | 6 | 7 | 8 | 9 | 10 | L1 | L2 |
|------|------|------|------|------|------|------|------|------|------|------|------|------|------|
| 2694 | 2964 | 2904 | 3085 | 3265 | 3445 | 3625 | 3805 | 3985 | 4165 | 4345 | 4525 | 4722 | 5370 |

Tight Seat & Back / Removable Seat & Back Upholstery / Three Position Mechanism / 600 lb. Weight Capacity

1056-D

| ARM CAPS / POWER / COVERS | OPTION #: | SPECIFICATIONS LIST PRICES AVAILABILITY: | | | | | | | | | | | | | | | | | | | | | | | | | | | |
|---|--|--|-----|-----|-----|-----|-----|-----|-----|-----|-----|-----|-----|----|----|-----|-----|-----|-----|-----|-----|-----|-----|-----|-----|-----|-----|-----|-----|
| <p>ARM CAPS</p>  | <p>Overall: 2.5"w 28"d .25"h</p> <p>SSAC \$732 (Set Of 2) Solid Surface <i>Glacier White Arm Cap (Additional Colors Available)</i></p> <p>PAC \$305 (Set Of 2) Polyester <i>Black Polyester Arm Cap (Additional Colors Available)</i></p> <p>VAC (Set Of 2) Vinyl Wrapped (<i>Specify Upholstery</i>) <i>COM: .5 yds. / COL: 9 sq.ft.</i></p> <table border="1"> <thead> <tr> <th>COM</th> <th>COL</th> <th>1</th> <th>2</th> <th>3</th> <th>4</th> <th>5</th> <th>6</th> <th>7</th> <th>8</th> <th>9</th> <th>10</th> <th>L1</th> <th>L2</th> </tr> </thead> <tbody> <tr> <td>325</td> <td>357</td> <td>329</td> <td>341</td> <td>352</td> <td>363</td> <td>374</td> <td>386</td> <td>397</td> <td>408</td> <td>419</td> <td>431</td> <td>438</td> <td>479</td> </tr> </tbody> </table> <p>Available: Ace Collection</p> | COM | COL | 1 | 2 | 3 | 4 | 5 | 6 | 7 | 8 | 9 | 10 | L1 | L2 | 325 | 357 | 329 | 341 | 352 | 363 | 374 | 386 | 397 | 408 | 419 | 431 | 438 | 479 |
| COM | COL | 1 | 2 | 3 | 4 | 5 | 6 | 7 | 8 | 9 | 10 | L1 | L2 | | | | | | | | | | | | | | | | |
| 325 | 357 | 329 | 341 | 352 | 363 | 374 | 386 | 397 | 408 | 419 | 431 | 438 | 479 | | | | | | | | | | | | | | | | |
| <p>POWER / DATA MODULE</p>  <p>PM1 Power / Data Module</p>  <p>PM2 Power Module</p>  <p>USB-1 Dual Charging USB</p> | <p>PM1 Overall: 5.25"w 1.25"d 4.25"h PM2 Overall: 2"w 2"d .125"h USB-1 Overall: 2"w 2"d .125"h</p> <p>PM1 \$859 Power/Data Module (1-Power / 1-USB 2 Port Simplex Charger Standard) <i>Vertical / Horizontal Mount Power Module. Price Varies By Socket. Contact Customer Service For Quote. (Additional Colors Available)</i></p> <p>PM2 \$238 Power Module (1-Power) <i>Spill-Proof Technology / Multiple Finish Options / Storm Color Standard (Specify Left or Right Facing)</i></p> <p>USB-1 \$238 Dual Charging USB (2 Port Simplex Charger Standard) <i>Spill-Proof Technology / 2 Amps Per Port / Multiple Finish Options / Storm Color Standard (Specify Left or Right Facing)</i></p> <p>Available: Ace Collection</p> | | | | | | | | | | | | | | | | | | | | | | | | | | | | |
| <p>HEAT & MASSAGE</p>   <p>HM Heat & Massage (All Recliner Models)</p> <p>H Heat (All Recliner Models)</p> | <p>Overall: 2.5"w .25"d 1.75"h</p> <p>HM \$1403 Heat & Massage <i>Add Heat & Massage To Any Wallsaver, Layflat, Or Standup Electric Recliner - Surface Mounts On Inside Arm (Specify Left Or Right Facing)</i></p> <p>H \$1023 Heat <i>Add Heat Only To Any Wallsaver, Layflat, Or Standup Electric Recliner - Surface Mounts On Inside Arm (Specify Left Or Right Facing)</i></p> <p>Available: Ace Collection</p> | | | | | | | | | | | | | | | | | | | | | | | | | | | | |
| <p>Non-Removable Seat</p>  | <p>Seat: 21"w 21.5"d 4"h</p> <p>NRS \$50 Non-Removable Seat</p> <p>Available: Ace Collection</p> | | | | | | | | | | | | | | | | | | | | | | | | | | | | |
| <p>CONTRASTING COVERS</p>  | <p>Overall: N/A</p> <p>CC \$129 <i>NOTE: If Two Or More Upholsteries Or Leathers Are Used On Any Piece Of Furniture, Then A Contrast Charge Will Apply Per Order. When Using Trinity Upholstery, The Higher Priced Upholstery Grade Will Be Used In Pricing, Unless It's Trinity Leather With Fabric Contrast Welt, Or COM With Trinity Contrast Welt, Then Contact Customer Service For Pricing.</i></p> <p>Available: Ace Collection</p> | | | | | | | | | | | | | | | | | | | | | | | | | | | | |

Austen

LOUNGE / BENCHES

Effective: March 1, 2025

T R I N I T Y

Date:

Page:

Modification:

Description:

DESCRIPTION:

- Upholstery Frames: Steel, Plywood & Hardwood
- Seat: High Density Polyurethane Foam Over Strap Webbing
- Back: High Density Polyurethane Foam Over Plywood
- Upholstered Covers: Stapled On Seat & Back
- Urethane Arm Caps - Standard
- Exposed Metal Legs: 14 Gauge Steel Tubing / Powder Coated (Wallsaver Back Legs)
- Leather Upholstery Not Available
- Adjustable Height Leveling Glides Standard
- 10 Year Warranty

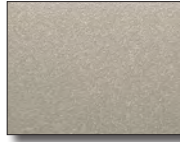

Leg Color: Champagne

OPTIONS:

- EPAC-2 Black Polyester Arm Caps (Set Of 2).....\$393
- EWAC-1 Wood Arm Caps (Set Of 2).....No Upcharge
- SSAC-1 Solid Surface Arm Caps (Set Of 2).....\$974
- RUC-L Removable Upholstery Covers\$150 Per Lounge Chair
- CC Contrasting Covers.....\$129

All Austen Components Are Field Replaceable.

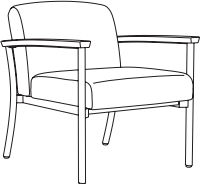
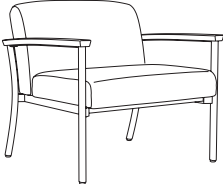
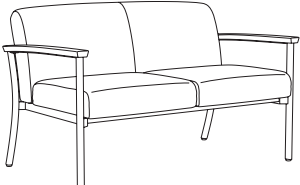
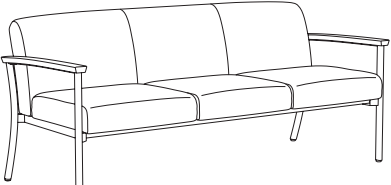
| LOUNGE | | ITEM #: | SPECIFICATIONS GRADES LIST PRICES: | | | | | | | | | | | | |
|---|--------|---------------------------------------|--|------------------------|----------|-----------------------|----------|----------|----------|----------|----------|----------|-----------|-----------|-----------|
|  | 1901 | Overall: 26.125"w 29.75"d 32"h | | Arm: 25"h | | COM: 2.5 yds. | | | | | | | | | |
| | | Seat: 22.5"w 20.5"d 19"h | | Weight: TBD | | COL: n/a | | | | | | | | | |
| | | COM | COL | 1 | 2 | 3 | 4 | 5 | 6 | 7 | 8 | 9 | 10 | L1 | L2 |
| | | 1497 | N/A | 1529 | 1588 | 1648 | 1707 | 1767 | 1826 | 1885 | 1945 | 2004 | 2063 | N/A | N/A |
| <i>Tight Seat & Back / 500 lb. Weight Capacity</i> | | | | | | | | | | | | | | | |
|  | 1901-X | Overall: 32.125"w 29.75"d 32h | | Arm: 25"h | | COM: 3.0 yds. | | | | | | | | | |
| | | Seat: 28.5"w 20.5"d 19"h | | Weight: TBD | | COL: n/a | | | | | | | | | |
| | | COM | COL | 1 | 2 | 3 | 4 | 5 | 6 | 7 | 8 | 9 | 10 | L1 | L2 |
| | | 1648 | N/A | 1695 | 1767 | 1838 | 1909 | 1980 | 2051 | 2123 | 2194 | 2265 | 2336 | N/A | N/A |
| <i>Tight Seat & Back / 750 lb. Weight Capacity</i> | | | | | | | | | | | | | | | |
|  | 1902 | Overall: 48.375"w 29.75"d 32"h | | Arm: 25"h | | COM: 4.75 yds. | | | | | | | | | |
| | | Seat: 44.75"w 20.5"d 19"h | | Weight: 45 lbs. | | COL: n/a | | | | | | | | | |
| | | COM | COL | 1 | 2 | 3 | 4 | 5 | 6 | 7 | 8 | 9 | 10 | L1 | L2 |
| | | 1913 | N/A | 2026 | 2137 | 2247 | 2358 | 2469 | 2579 | 2690 | 2800 | 2911 | 3022 | N/A | N/A |
| <i>Tight Seat & Back / 750 lb. Weight Capacity</i> | | | | | | | | | | | | | | | |
|  | 1903 | Overall: 70.375"w 29.75"d 32"h | | Arm: 25"h | | COM: 7.0 yds. | | | | | | | | | |
| | | Seat: 66.75"w 20.5"d 19"h | | Weight: TBD | | COL: n/a | | | | | | | | | |
| | | COM | COL | 1 | 2 | 3 | 4 | 5 | 6 | 7 | 8 | 9 | 10 | L1 | L2 |
| | | 2398 | N/A | 2592 | 2759 | 2925 | 3091 | 3257 | 3423 | 3590 | 3756 | 3922 | 4088 | N/A | N/A |
| <i>Tight Seat & Back / 1000 lb. Weight Capacity</i> | | | | | | | | | | | | | | | |

DESCRIPTION:

- Upholstery Frames: Steel, Plywood & Hardwood
- Seat: High Density Polyurethane Foam Over Strap Webbing
- Back: High Density Polyurethane Foam Over Plywood
- Upholstered Covers: Stapled On Seat & Back
- Urethane Arm Caps - Standard
- Exposed Metal Legs: 14 Gauge Steel Tubing / Powder Coated (Wallsaver Back Legs)
- Leather Upholstery Not Available
- Adjustable Height Leveling Glides Standard
- 10 Year Warranty

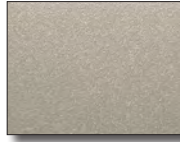

Leg Color: Champagne

OPTIONS:

- EPAC-2 Black Polyester Arm Caps (Set Of 2).....\$393
- EWAC-1 Wood Arm Caps (Set Of 2).....No Upcharge
- SSAC-1 Solid Surface Arm Caps (Set Of 2).....\$974
- RUC-L Removable Upholstery Covers\$150 Per Lounge Chair
- CC Contrasting Covers.....\$129

All Austen Components Are Field Replaceable.

LOUNGE

ITEM #:

SPECIFICATIONS | GRADES | LIST PRICES:

HIGH BACK LOUNGE CHAIR / OPEN URETHANE ARMS

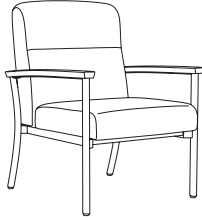

1904

Overall: 26.125" w 29.75" d 38.625" h **Arm:** 25" h **COM:** 2.75 yds.
Seat: 22.5" w 20.5" d 19" h **Weight:** TBD **COL:** n/a

| COM | COL | 1 | 2 | 3 | 4 | 5 | 6 | 7 | 8 | 9 | 10 | L1 | L2 |
|------|-----|------|------|------|------|------|------|------|------|------|------|-----|-----|
| 1572 | N/A | 1600 | 1660 | 1719 | 1778 | 1838 | 1897 | 1956 | 2016 | 2075 | 2135 | N/A | N/A |

Tight Seat & Back / 500 lb. Weight Capacity

BARIATRIC HIGH BACK LOUNGE CHAIR / OPEN URETHANE ARMS

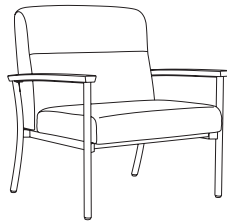

1904-X

Overall: 32.125" w 29.75" d 38.625" h **Arm:** 25" h **COM:** 3.25 yds.
Seat: 28.5" w 20.5" d 19" h **Weight:** TBD **COL:** n/a

| COM | COL | 1 | 2 | 3 | 4 | 5 | 6 | 7 | 8 | 9 | 10 | L1 | L2 |
|------|-----|------|------|------|------|------|------|------|------|------|------|-----|-----|
| 1774 | N/A | 1814 | 1885 | 1956 | 2028 | 2099 | 2170 | 2241 | 2313 | 2384 | 2455 | N/A | N/A |

Tight Seat & Back / 750 lb. Weight Capacity

HIGH BACK TWO PLACE SOFA / OPEN URETHANE ARMS

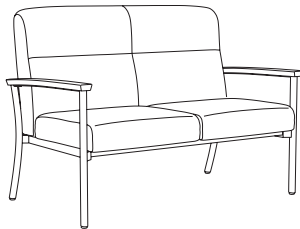

1905

Overall: 48.375" w 29.75" d 38.625" h **Arm:** 25" h **COM:** 5.0 yds.
Seat: 44.75" w 20.5" d 19" h **Weight:** TBD **COL:** n/a

| COM | COL | 1 | 2 | 3 | 4 | 5 | 6 | 7 | 8 | 9 | 10 | L1 | L2 |
|------|-----|------|------|------|------|------|------|------|------|------|------|-----|-----|
| 1987 | N/A | 2096 | 2207 | 2317 | 2428 | 2538 | 2649 | 2760 | 2870 | 2981 | 3092 | N/A | N/A |

Tight Seat & Back / 750 lb. Weight Capacity

HIGH BACK THREE PLACE SOFA / OPEN URETHANE ARMS

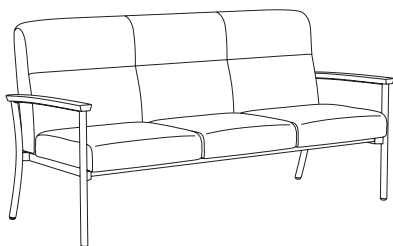

1906

Overall: 70.375" w 29.75" d 38.625" h **Arm:** 25" h **COM:** 7.25 yds.
Seat: 66.75" w 20.5" d 19" h **Weight:** TBD **COL:** n/a

| COM | COL | 1 | 2 | 3 | 4 | 5 | 6 | 7 | 8 | 9 | 10 | L1 | L2 |
|------|-----|------|------|------|------|------|------|------|------|------|------|-----|-----|
| 2499 | N/A | 2687 | 2854 | 3020 | 3186 | 3352 | 3518 | 3685 | 3851 | 4017 | 4183 | N/A | N/A |

Tight Seat & Back / 1000 lb. Weight Capacity

DESCRIPTION:

- Upholstery Frames: Steel, Plywood & Hardwood
- Seat: High Density Polyurethane Foam Over Strap Webbing
- Back: High Density Polyurethane Foam Over Plywood
- Upholstered Covers: Stapled On Seat & Back
- Urethane Arm Caps - Standard
- Exposed Metal Legs: 14 Gauge Steel Tubing / Powder Coated (Wallsaver Back Legs)
- Leather Upholstery Not Available
- Adjustable Height Leveling Glides Standard
- 10 Year Warranty

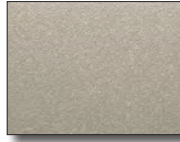

Leg Color: Champagne

OPTIONS:

RUC-B Removable Upholstery Covers \$100 Per Bench

All Austen Components Are Field Replaceable.

BENCHES

ITEM #:

SPECIFICATIONS | GRADES | LIST PRICES:

SINGLE SEAT BENCH



1911

| Overall: 31.75"w 22"d 19"h | | Arm: n/a | | COM: 1.5 yds. | | | | | | | | | |
|-----------------------------------|-----|--------------------|-----|----------------------|-----|------|------|------|------|------|------|-----|-----|
| Seat: 31.75"w 22"d 19"h | | Weight: TBD | | COL: n/a | | | | | | | | | |
| COM | COL | 1 | 2 | 3 | 4 | 5 | 6 | 7 | 8 | 9 | 10 | L1 | L2 |
| 845 | N/A | 867 | 900 | 934 | 968 | 1001 | 1035 | 1069 | 1102 | 1136 | 1170 | N/A | N/A |

Tight Seat / 500 lb. Weight Capacity

DOUBLE SEAT BENCH

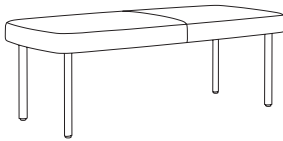

1912

| Overall: 54"w 22"d 19"h | | Arm: n/a | | COM: 3.25 yds. | | | | | | | | | |
|--------------------------------|-----|--------------------|------|-----------------------|------|------|------|------|------|------|------|-----|-----|
| Seat: 54"w 22"d 19"h | | Weight: TBD | | COL: n/a | | | | | | | | | |
| COM | COL | 1 | 2 | 3 | 4 | 5 | 6 | 7 | 8 | 9 | 10 | L1 | L2 |
| 1344 | N/A | 1417 | 1490 | 1563 | 1636 | 1709 | 1782 | 1855 | 1928 | 2000 | 2073 | N/A | N/A |

Tight Seat / 500 lb. Weight Capacity

| ARM CAPS / COVERS | OPTION #: | SPECIFICATIONS LIST PRICES AVAILABILITY: |
|--|---|---|
| <p>POLYESTER ARM CAPS</p>  | <p>EPAC-2</p> | <p>Overall: 2.75"w 22.5"d 1.125"h</p> <hr/> <p>\$393 (Set Of 2) POLYESTER <i>Black Polyester Arm Cap (Additional Colors Available)</i></p> <p>Available: Austen Lounge Collection</p> |
| <p>WOOD ARM CAPS / SOLID SURFACE ARM CAPS</p>  | <p>EWAC-1</p> <p>SSAC-1</p> | <p>Overall: 2.75"w 22.5"d 1.125"h</p> <hr/> <p>NO UPCHARGE (Set Of 2) WOOD <i>Wood Arm Cap (Specify Finish)</i></p> <p>Available: Austen Lounge Collection</p> <hr/> <p>\$974 (Set Of 2) SOLID SURFACE <i>White Solid Surface Arm Cap (Additional Colors Available - Call For Pricing)</i></p> <p>Available: Austen Lounge Collection</p> |
| <p>REMOVABLE UPHOLSTERY COVERS - LOUNGE / BENCHES</p>  | <p>RUC-L</p> <p>RUC-B</p> | <p>Overall: N/A</p> <hr/> <p>\$150 LIST UPCHARGE PER LOUNGE CHAIR <i>Removable Upholstery Covers Attached w/ Velcro (Antimicrobial Moisture Barrier Fully Encapsulates All Foam Areas)</i></p> <p>Available: Austen Standard & High-Back Lounge</p> <hr/> <p>\$100 LIST UPCHARGE PER BENCH <i>Removable Upholstery Covers Attached w/ Velcro (Antimicrobial Moisture Barrier Fully Encapsulates All Foam Areas)</i></p> <p>Available: Austen Benches</p> |
| <p>CONTRASTING COVERS</p>  | <p>CC</p> | <p>Overall: N/A</p> <hr/> <p>\$129</p> <p><i>NOTE: If Two Or More Upholsteries Or Leathers Are Used On Any Piece Of Furniture, Then A Contrast Charge Will Apply Per Order. When Using Trinity Upholstery, The Higher Priced Upholstery Grade Will Be Used In Pricing, Unless It's Trinity Leather With Fabric Contrast Welt, Or COM With Trinity Contrast Welt, Then Contact Customer Service For Pricing.</i></p> <p>Available: Austen Lounge Collection</p> |

Austen

GUEST / TANDEM / TABLES

Effective: March 1, 2025

T R I N I T Y

Date:

Page:

Modification:

Description:

DESCRIPTION:

- Upholstery Frames: Steel, Plywood & Hardwood
- Seat: High Density Polyurethane Foam Over Strap Webbing
- Back: High Density Polyurethane Foam Over Plywood
- Upholstered Covers: Stapled On Seat & Back
- Urethane Arm Caps - Standard
- Exposed Metal Legs: 14 Gauge Steel Tubing / Powder Coated (Wallsaver Back Legs)
- Leather Upholstery Not Available
- Adjustable Height Leveling Glides Standard
- 10 Year Warranty

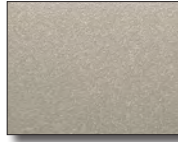

Leg Color: Champagne

OPTIONS:

- EPAC-1 Black Polyester Arm Caps (Set Of 2).....\$374
- AWAC-1 Wood Arm Caps (Set Of 2).....No Upcharge
- SSAC-2 Solid Surface Arm Caps (Set Of 2).....\$737
- RUC-G Removable Upholstery Covers \$100 Chair
- CC Contrasting Covers.....\$129

All Austen Components Are Field Replaceable.

NOTE: All Seating Configurations Are Viewed From Left To Right Facing. Please Attach A Layout Showing Seating Configuration w/ Your Order. Assembled Units Must Be Shipped In Configurations Of 3 Or Less.

GUEST / TANDEM

ITEM #:

SPECIFICATIONS | GRADES | LIST PRICES:

ARM SIDE CHAIR / URETHANE ARMS

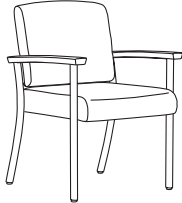

1922: 20" Seat Width
1924: 24" Seat Width

1922

| | | | | | | | | | | | | | |
|--|-----|------------------------|------|-----------------------|------|------|------|------|------|------|------|-----|-----|
| Overall: 23.25"w 25.5"d 34"h | | Arm: 25"h | | COM: 1.75 yds. | | | | | | | | | |
| Seat: 20"w 18.25"d 18.5"h | | Weight: 45 lbs. | | COL: n/a | | | | | | | | | |
| COM | COL | 1 | 2 | 3 | 4 | 5 | 6 | 7 | 8 | 9 | 10 | L1 | L2 |
| 1049 | N/A | 1070 | 1091 | 1121 | 1152 | 1183 | 1213 | 1244 | 1274 | 1305 | 1335 | N/A | N/A |
| Open Back / Tight Seat & Back / 20" Seat Width / 350 lb. Weight Capacity | | | | | | | | | | | | | |

1924

| | | | | | | | | | | | | | |
|--|-----|------------------------|------|--------------------|------|------|------|------|------|------|------|-----|-----|
| Overall: 27.25"w 25.5"d 34"h | | Arm: 25"h | | COM: 2 yds. | | | | | | | | | |
| Seat: 24"w 18.25"d 18.5"h | | Weight: 50 lbs. | | COL: n/a | | | | | | | | | |
| COM | COL | 1 | 2 | 3 | 4 | 5 | 6 | 7 | 8 | 9 | 10 | L1 | L2 |
| 1408 | N/A | 1449 | 1495 | 1552 | 1608 | 1664 | 1720 | 1776 | 1832 | 1888 | 1944 | N/A | N/A |
| Open Back / Tight Seat & Back / 24" Seat Width / 350 lb. Weight Capacity | | | | | | | | | | | | | |

ARM CHAIR / URETHANE ARMS / ACCEPTS SEAT ON RIGHT

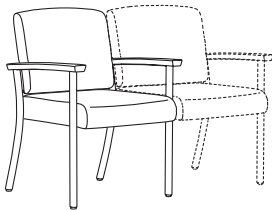

1922-C

| | | | | | | | | | | | | | |
|---|-----|------------------------|------|-----------------------|------|------|------|------|------|------|------|-----|-----|
| Overall: 23.25"w 25.5"d 34"h | | Arm: 25"h | | COM: 1.75 yds. | | | | | | | | | |
| Seat: 20"w 18.25"d 18.5"h | | Weight: 45 lbs. | | COL: n/a | | | | | | | | | |
| COM | COL | 1 | 2 | 3 | 4 | 5 | 6 | 7 | 8 | 9 | 10 | L1 | L2 |
| 1149 | N/A | 1158 | 1195 | 1233 | 1270 | 1307 | 1345 | 1382 | 1420 | 1457 | 1494 | N/A | N/A |
| Open Back / Tight Seat & Back / 350 lb. Weight Capacity | | | | | | | | | | | | | |

ARM CHAIR / URETHANE ARMS / ACCEPTS TABLE ON RIGHT

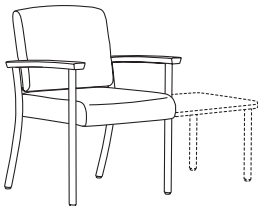

1922-T

| | | | | | | | | | | | | | |
|---|-----|------------------------|------|-----------------------|------|------|------|------|------|------|------|-----|-----|
| Overall: 23.25"w 25.5"d 34"h | | Arm: 25"h | | COM: 1.75 yds. | | | | | | | | | |
| Seat: 20"w 18.25"d 18.5"h | | Weight: 45 lbs. | | COL: n/a | | | | | | | | | |
| COM | COL | 1 | 2 | 3 | 4 | 5 | 6 | 7 | 8 | 9 | 10 | L1 | L2 |
| 1049 | N/A | 1070 | 1091 | 1121 | 1152 | 1183 | 1213 | 1244 | 1274 | 1305 | 1335 | N/A | N/A |
| Open Back / Tight Seat & Back / 350 lb. Weight Capacity | | | | | | | | | | | | | |

ARM CHAIR / URETHANE ARMS / ACCEPTS TABLE ON LEFT

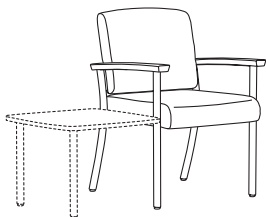

1922-LT

| | | | | | | | | | | | | | |
|---|-----|------------------------|------|-----------------------|------|------|------|------|------|------|------|-----|-----|
| Overall: 23.25"w 25.5"d 34"h | | Arm: 25"h | | COM: 1.75 yds. | | | | | | | | | |
| Seat: 20"w 18.25"d 18.5"h | | Weight: 45 lbs. | | COL: n/a | | | | | | | | | |
| COM | COL | 1 | 2 | 3 | 4 | 5 | 6 | 7 | 8 | 9 | 10 | L1 | L2 |
| 1049 | N/A | 1070 | 1091 | 1121 | 1152 | 1183 | 1213 | 1244 | 1274 | 1305 | 1335 | N/A | N/A |
| Open Back / Tight Seat & Back / 350 lb. Weight Capacity | | | | | | | | | | | | | |

DESCRIPTION:

- Upholstery Frames: Steel, Plywood & Hardwood
- Seat: High Density Polyurethane Foam Over Strap Webbing
- Back: High Density Polyurethane Foam Over Plywood
- Upholstered Covers: Stapled On Seat & Back
- Urethane Arm Caps - Standard
- Exposed Metal Legs: 14 Gauge Steel Tubing / Powder Coated (Wallsaver Back Legs)
- Leather Upholstery Not Available
- Adjustable Height Leveling Glides Standard
- 10 Year Warranty

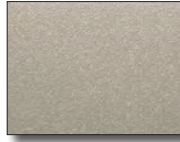

Leg Color: Champagne

OPTIONS:

- EPAC-1 Black Polyester Arm Caps (Set Of 2).....\$374
- AWAC-1 Wood Arm Caps (Set Of 2).....No Upcharge
- SSAC-2 Solid Surface Arm Caps (Set Of 2).....\$737
- RUC-G Removable Upholstery Covers \$100 Chair
- CC Contrasting Covers.....\$129

All Austen Components Are Field Replaceable.

NOTE: All Seating Configurations Are Viewed From Left To Right Facing. Please Attach A Layout Showing Seating Configuration w/ Your Order. Assembled Units Must Be Shipped In Configurations Of 3 Or Less.

TANDEM

ITEM #:

SPECIFICATIONS | GRADES | LIST PRICES:

ARM CHAIR / URETHANE ARMS / ACCEPTS TABLE ON LEFT / SEAT ON RIGHT

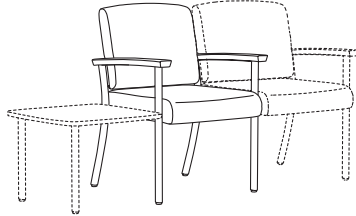

1922-TC

Overall: 23.25"w 25.5"d 34"h **Arm:** 25"h **COM:** 1.75 yds.
Seat: 20"w 18.25"d 18.5"h **Weight:** 45 lbs. **COL:** n/a

| COM | COL | 1 | 2 | 3 | 4 | 5 | 6 | 7 | 8 | 9 | 10 | L1 | L2 |
|------|-----|------|------|------|------|------|------|------|------|------|------|-----|-----|
| 1149 | N/A | 1158 | 1195 | 1233 | 1270 | 1307 | 1345 | 1382 | 1420 | 1457 | 1494 | N/A | N/A |

Open Back / Tight Seat & Back / 350 lb. Weight Capacity

ARM CHAIR / URETHANE ARMS / ACCEPTS TABLE ON LEFT / RIGHT

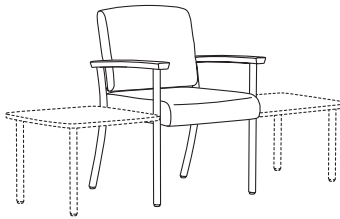

1922-TT

Overall: 23.25"w 25.5"d 34"h **Arm:** 25"h **COM:** 1.75 yds.
Seat: 20"w 18.25"d 18.5"h **Weight:** 45 lbs. **COL:** n/a

| COM | COL | 1 | 2 | 3 | 4 | 5 | 6 | 7 | 8 | 9 | 10 | L1 | L2 |
|------|-----|------|------|------|------|------|------|------|------|------|------|-----|-----|
| 1049 | N/A | 1070 | 1091 | 1121 | 1152 | 1183 | 1213 | 1244 | 1274 | 1305 | 1335 | N/A | N/A |

Open Back / Tight Seat & Back / 350 lb. Weight Capacity

DESCRIPTION:

- Upholstery Frames: Steel, Plywood & Hardwood
- Seat: High Density Polyurethane Foam Over Strap Webbing
- Back: High Density Polyurethane Foam Over Plywood
- Upholstered Covers: Stapled On Seat & Back
- Urethane Arm Caps - Standard
- Exposed Metal Legs: 14 Gauge Steel Tubing / Powder Coated (Wallsaver Back Legs, Except 1925 Patient Chair)
- Leather Upholstery Not Available
- Adjustable Height Leveling Glides Standard
- 10 Year Warranty

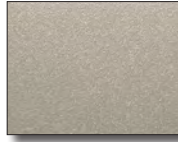

Leg Color: Champagne

OPTIONS:

- EPAC-1 Black Polyester Arm Caps (Set Of 2).....\$374
- AWAC-1 Wood Arm Caps (Set Of 2).....No Upcharge
- SSAC-2 Solid Surface Arm Caps (Set Of 2).....\$737
- RUC-G Removable Upholstery Covers \$100 Chair
- CC Contrasting Covers.....\$129

All Austen Components Are Field Replaceable.

NOTE: All Seating Configurations Are Viewed From Left To Right Facing. Please Attach A Layout Showing Seating Configuration w/ Your Order. Assembled Units Must Be Shipped In Configurations Of 3 Or Less.

TANDEM

ITEM #: SPECIFICATIONS | GRADES | LIST PRICES:

ADD-A-SEAT / URETHANE ARMS

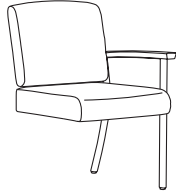

1923

| Overall: 21.75"w 25.5"d 34"h | | Arm: 25"h | | COM: 1.75 yds. | | | | | | | | | |
|-------------------------------------|-----|------------------------|------|-----------------------|------|------|------|------|------|------|------|-----|-----|
| Seat: 20"w 18.25"d 18.5"h | | Weight: 40 lbs. | | COL: n/a | | | | | | | | | |
| COM | COL | 1 | 2 | 3 | 4 | 5 | 6 | 7 | 8 | 9 | 10 | L1 | L2 |
| 977 | N/A | 983 | 1014 | 1045 | 1076 | 1107 | 1139 | 1170 | 1201 | 1232 | 1263 | N/A | N/A |

Open Back / Tight Seat & Back / 350 lb. Weight Capacity

ADD-A-SEAT / URETHANE ARMS / ACCEPTS SEAT ON RIGHT

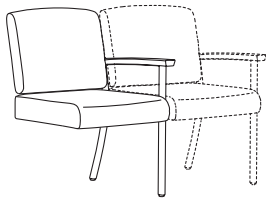

1923-C

| Overall: 21.75"w 25.5"d 34"h | | Arm: 25"h | | COM: 1.75 yds. | | | | | | | | | |
|-------------------------------------|-----|------------------------|------|-----------------------|------|------|------|------|------|------|------|-----|-----|
| Seat: 20"w 18.25"d 18.5"h | | Weight: 40 lbs. | | COL: n/a | | | | | | | | | |
| COM | COL | 1 | 2 | 3 | 4 | 5 | 6 | 7 | 8 | 9 | 10 | L1 | L2 |
| 977 | N/A | 983 | 1014 | 1045 | 1076 | 1107 | 1139 | 1170 | 1201 | 1232 | 1263 | N/A | N/A |

Open Back / Tight Seat & Back / 350 lb. Weight Capacity

ADD-A-SEAT / URETHANE ARMS / ACCEPTS TABLE ON RIGHT

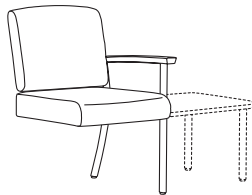

1923-T

| Overall: 21.75"w 25.5"d 34"h | | Arm: 25"h | | COM: 1.75 yds. | | | | | | | | | |
|-------------------------------------|-----|------------------------|------|-----------------------|------|------|------|------|------|------|------|-----|-----|
| Seat: 20"w 18.25"d 18.5"h | | Weight: 40 lbs. | | COL: n/a | | | | | | | | | |
| COM | COL | 1 | 2 | 3 | 4 | 5 | 6 | 7 | 8 | 9 | 10 | L1 | L2 |
| 977 | N/A | 983 | 1014 | 1045 | 1076 | 1107 | 1139 | 1170 | 1201 | 1232 | 1263 | N/A | N/A |

Open Back / Tight Seat & Back / 350 lb. Weight Capacity

HIGH BACK PATIENT CHAIR / URETHANE ARMS

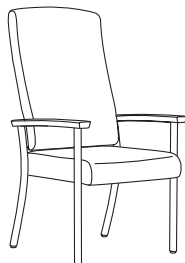

1925

| Overall: 23.25"w 25.5"d 45"h | | Arm: 25"h | | COM: 2.25 yds. | | | | | | | | | |
|-------------------------------------|-----|------------------------|------|-----------------------|------|------|------|------|------|------|------|-----|-----|
| Seat: 20"w 18.25"d 18.5"h | | Weight: 50 lbs. | | COL: n/a | | | | | | | | | |
| COM | COL | 1 | 2 | 3 | 4 | 5 | 6 | 7 | 8 | 9 | 10 | L1 | L2 |
| 1281 | N/A | 1330 | 1376 | 1432 | 1488 | 1544 | 1600 | 1656 | 1712 | 1768 | 1825 | N/A | N/A |

Open Back / Tight Seat & Back / 350 lb. Weight Capacity

DESCRIPTION:

- Upholstery Frames: Steel, Plywood & Hardwood
- Seat: High Density Polyurethane Foam Over Strap Webbing
- Back: High Density Polyurethane Foam Over Plywood
- Upholstered Covers: Stapled On Seat & Back
- Urethane Arm Caps - Standard
- Exposed Metal Legs: 14 Gauge Steel Tubing / Powder Coated (Wallsaver Back Legs)
- Leather Upholstery Not Available
- Adjustable Height Leveling Glides Standard
- 10 Year Warranty

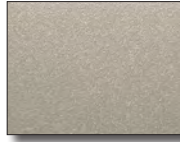

Leg Color: Champagne

OPTIONS:

- EPAC-1 Black Polyester Arm Caps (Set Of 2).....\$374
- AWAC-1 Wood Arm Caps (Set Of 2).....No Upcharge
- SSAC-2 Solid Surface Arm Caps (Set Of 2).....\$737
- RUC-G Removable Upholstery Covers \$100 Chair
- CC Contrasting Covers.....\$129

All Austen Components Are Field Replaceable.

NOTE: All Seating Configurations Are Viewed From Left To Right Facing. Please Attach A Layout Showing Seating Configuration w/ Your Order. Assembled Units Must Be Shipped In Configurations Of 3 Or Less.

| BARIATRIC / TANDEM | | ITEM #: | SPECIFICATIONS GRADES LIST PRICES: | | | | | | | | | | | | | | | |
|--------------------|---------|--|--|--|------|------|------|------|------|------|------|------|------|-----|-----|----|----|----|
| | 1932 | BARIATRIC CHAIR / URETHANE ARMS <i>Overall: 33.25"w 25.5"d 34"h</i> <i>Seat: 30"w 18.25"d 18.5"h</i> | <i>Arm: 25"h</i> Weight: 55 lbs. | COM: 2.25 yds. COL: n/a | COM | COL | 1 | 2 | 3 | 4 | 5 | 6 | 7 | 8 | 9 | 10 | L1 | L2 |
| | | 1440 | N/A | 1457 | 1507 | 1557 | 1606 | 1656 | 1706 | 1756 | 1806 | 1856 | 1906 | N/A | N/A | | | |
| | | Open Back / Tight Seat & Back / 500 lb. Weight Capacity | | | | | | | | | | | | | | | | |
| | 1932-C | BARIATRIC CHAIR / URETHANE ARMS / ACCEPTS SEAT ON RIGHT <i>Overall: 33.25"w 25.5"d 34"h</i> <i>Seat: 30"w 18.25"d 18.5"h</i> | <i>Arm: 25"h</i> Weight: 55 lbs. | COM: 2.25 yds. COL: n/a | COM | COL | 1 | 2 | 3 | 4 | 5 | 6 | 7 | 8 | 9 | 10 | L1 | L2 |
| | | 1451 | N/A | 1467 | 1517 | 1567 | 1616 | 1666 | 1716 | 1766 | 1816 | 1866 | 1916 | N/A | N/A | | | |
| | | Open Back / Tight Seat & Back / 500 lb. Weight Capacity | | | | | | | | | | | | | | | | |
| | 1932-T | BARIATRIC CHAIR / URETHANE ARMS / ACCEPTS TABLE ON RIGHT <i>Overall: 33.25"w 25.5"d 34"h</i> <i>Seat: 30"w 18.25"d 18.5"h</i> | <i>Arm: 25"h</i> Weight: 55 lbs. | COM: 2.25 yds. COL: n/a | COM | COL | 1 | 2 | 3 | 4 | 5 | 6 | 7 | 8 | 9 | 10 | L1 | L2 |
| | | 1440 | N/A | 1457 | 1507 | 1557 | 1606 | 1656 | 1706 | 1756 | 1806 | 1856 | 1906 | N/A | N/A | | | |
| | | Open Back / Tight Seat & Back / 500 lb. Weight Capacity | | | | | | | | | | | | | | | | |
| | 1932-LT | BARIATRIC CHAIR / URETHANE ARMS / ACCEPTS TABLE ON LEFT <i>Overall: 33.25"w 25.5"d 34"h</i> <i>Seat: 30"w 18.25"d 18.5"h</i> | <i>Arm: 25"h</i> Weight: 55 lbs. | COM: 2.25 yds. COL: n/a | COM | COL | 1 | 2 | 3 | 4 | 5 | 6 | 7 | 8 | 9 | 10 | L1 | L2 |
| | | 1440 | N/A | 1457 | 1507 | 1557 | 1606 | 1656 | 1706 | 1756 | 1806 | 1856 | 1906 | N/A | N/A | | | |
| | | Open Back / Tight Seat & Back / 500 lb. Weight Capacity | | | | | | | | | | | | | | | | |

DESCRIPTION:

- Upholstery Frames: Steel, Plywood & Hardwood
- Seat: High Density Polyurethane Foam Over Strap Webbing
- Back: High Density Polyurethane Foam Over Plywood
- Upholstered Covers: Stapled On Seat & Back
- Urethane Arm Caps - Standard
- Exposed Metal Legs: 14 Gauge Steel Tubing / Powder Coated (Wallsaver Back Legs)
- Leather Upholstery Not Available
- Adjustable Height Leveling Glides Standard
- 10 Year Warranty

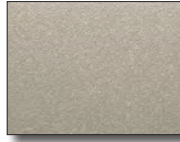

Leg Color: Champagne

OPTIONS:

- EPAC-1 Black Polyester Arm Caps (Set Of 2).....\$374
- AWAC-1 Wood Arm Caps (Set Of 2).....No Upcharge
- SSAC-2 Solid Surface Arm Caps (Set Of 2).....\$737
- RUC-G Removable Upholstery Covers \$100 Chair
- CC Contrasting Covers.....\$129

All Austen Components Are Field Replaceable.

NOTE: All Seating Configurations Are Viewed From Left To Right Facing. Please Attach A Layout Showing Seating Configuration w/ Your Order. Assembled Units Must Be Shipped In Configurations Of 3 Or Less.

BARIATRIC / TANDEM

ITEM #:

SPECIFICATIONS | GRADES | LIST PRICES:

BARIATRIC CHAIR / URETHANE ARMS / ACCEPTS TABLE ON LEFT / SEAT ON RIGHT

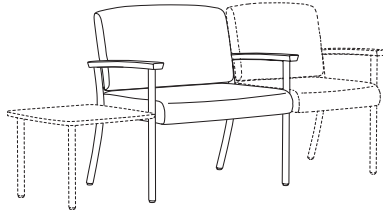

1932-TC

Overall: 33.25"w 25.5"d 34"h **Arm:** 25"h **COM:** 2.25 yds.
Seat: 30"w 18.25"d 18.5"h **Weight:** 55 lbs. **COL:** n/a

| COM | COL | 1 | 2 | 3 | 4 | 5 | 6 | 7 | 8 | 9 | 10 | L1 | L2 |
|------|-----|------|------|------|------|------|------|------|------|------|------|-----|-----|
| 1451 | N/A | 1467 | 1517 | 1567 | 1616 | 1666 | 1716 | 1766 | 1816 | 1866 | 1916 | N/A | N/A |

Open Back / Tight Seat & Back / 500 lb. Weight Capacity

BARIATRIC CHAIR / URETHANE ARMS / ACCEPTS TABLE ON LEFT / RIGHT

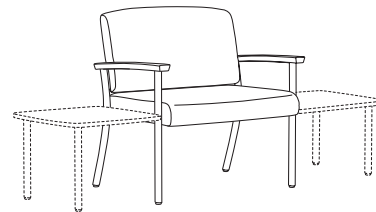

1932-TT

Overall: 33.25"w 25.5"d 34"h **Arm:** 25"h **COM:** 2.25 yds.
Seat: 30"w 18.25"d 18.5"h **Weight:** 55 lbs. **COL:** n/a

| COM | COL | 1 | 2 | 3 | 4 | 5 | 6 | 7 | 8 | 9 | 10 | L1 | L2 |
|------|-----|------|------|------|------|------|------|------|------|------|------|-----|-----|
| 1440 | N/A | 1457 | 1507 | 1557 | 1606 | 1656 | 1706 | 1756 | 1806 | 1856 | 1906 | N/A | N/A |

Open Back / Tight Seat & Back / 500 lb. Weight Capacity

DESCRIPTION:

- Upholstery Frames: Steel, Plywood & Hardwood
- Seat: High Density Polyurethane Foam Over Strap Webbing
- Back: High Density Polyurethane Foam Over Plywood
- Upholstered Covers: Stapled On Seat & Back
- Urethane Arm Caps - Standard
- Exposed Metal Legs: 14 Gauge Steel Tubing / Powder Coated (Wallsaver Back Legs)
- Leather Upholstery Not Available
- Adjustable Height Leveling Glides Standard
- 10 Year Warranty

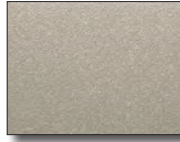

Leg Color: Champagne

OPTIONS:

- EPAC-1 Black Polyester Arm Caps (Set Of 2).....\$374
- AWAC-1 Wood Arm Caps (Set Of 2).....No Upcharge
- SSAC-2 Solid Surface Arm Caps (Set Of 2).....\$737
- RUC-G Removable Upholstery Covers \$100 Chair
- CC Contrasting Covers.....\$129

All Austen Components Are Field Replaceable.

NOTE: All Seating Configurations Are Viewed From Left To Right Facing. Please Attach A Layout Showing Seating Configuration w/ Your Order. Assembled Units Must Be Shipped In Configurations Of 3 Or Less.

BARIATRIC / TANDEM

ITEM #:

SPECIFICATIONS | GRADES | LIST PRICES:

BARIATRIC ADD-A-SEAT / URETHANE ARMS

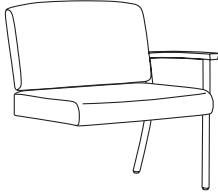

1933

Overall: 31.75"w 25.5"d 34"h **Arm:** 25"h **COM:** 2.25 yds.
Seat: 30"w 18.25"d 18.5"h **Weight:** 52 lbs. **COL:** n/a

| COM | COL | 1 | 2 | 3 | 4 | 5 | 6 | 7 | 8 | 9 | 10 | L1 | L2 |
|------|-----|------|------|------|------|------|------|------|------|------|------|-----|-----|
| 1256 | N/A | 1283 | 1333 | 1383 | 1433 | 1483 | 1533 | 1583 | 1632 | 1682 | 1732 | N/A | N/A |

Open Back / Tight Seat & Back / 500 lb. Weight Capacity

BARIATRIC ADD-A-SEAT / URETHANE ARMS / ACCEPTS SEAT ON RIGHT

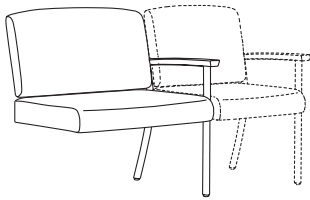

1933-C

Overall: 31.75"w 25.5"d 34"h **Arm:** 25"h **COM:** 2.25 yds.
Seat: 30"w 18.25"d 18.5"h **Weight:** 52 lbs. **COL:** n/a

| COM | COL | 1 | 2 | 3 | 4 | 5 | 6 | 7 | 8 | 9 | 10 | L1 | L2 |
|------|-----|------|------|------|------|------|------|------|------|------|------|-----|-----|
| 1256 | N/A | 1283 | 1333 | 1383 | 1433 | 1483 | 1533 | 1583 | 1632 | 1682 | 1732 | N/A | N/A |

Open Back / Tight Seat & Back / 500 lb. Weight Capacity

BARIATRIC ADD-A-SEAT / URETHANE ARMS / ACCEPTS TABLE ON RIGHT

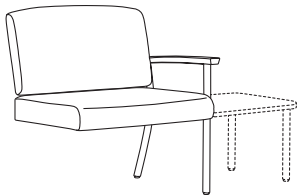

1933-T

Overall: 31.75"w 25.5"d 34"h **Arm:** 25"h **COM:** 2.25 yds.
Seat: 30"w 18.25"d 18.5"h **Weight:** 52 lbs. **COL:** n/a

| COM | COL | 1 | 2 | 3 | 4 | 5 | 6 | 7 | 8 | 9 | 10 | L1 | L2 |
|------|-----|------|------|------|------|------|------|------|------|------|------|-----|-----|
| 1256 | N/A | 1283 | 1333 | 1383 | 1433 | 1483 | 1533 | 1583 | 1632 | 1682 | 1732 | N/A | N/A |

Open Back / Tight Seat & Back / 500 lb. Weight Capacity

DESCRIPTION:

- Upholstery Frames: Steel, Plywood & Hardwood
- Seat: High Density Polyurethane Foam Over Strap Webbing
- Back: High Density Polyurethane Foam Over Plywood
- Upholstered Covers: Stapled On Seat & Back
- Urethane Arm Caps - Standard
- Exposed Metal Legs: 14 Gauge Steel Tubing / Powder Coated (Wallsaver Back Legs)
- Leather Upholstery Not Available
- Adjustable Height Leveling Glides Standard
- 10 Year Warranty



Leg Color: Champagne

OPTIONS:

- EPAC-1 Black Polyester Arm Caps (Set Of 2).....\$374
- AWAC-1 Wood Arm Caps (Set Of 2).....No Upcharge
- SSAC-2 Solid Surface Arm Caps (Set Of 2).....\$737
- RUC-G Removable Upholstery Covers \$100 Chair
- CC Contrasting Covers.....\$129

All Austen Components Are Field Replaceable.

NOTE: All Seating Configurations Are Viewed From Left To Right Facing. Please Attach A Layout Showing Seating Configuration w/ Your Order. Assembled Units Must Be Shipped In Configurations Of 3 Or Less.

TANDEM

ITEM #:

SPECIFICATIONS | GRADES | LIST PRICES:

TWO PLACE SOFA / URETHANE ARMS

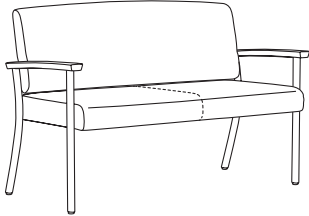

1950

Overall: 51.25"w 25.5"d 34"h **Arm:** 25"h **COM:** 3.5 yds.
Seat: 48"w 18.25"d 18.5"h **Weight:** 65 lbs. **COL:** n/a

| COM | COL | 1 | 2 | 3 | 4 | 5 | 6 | 7 | 8 | 9 | 10 | L1 | L2 |
|------|-----|------|------|------|------|------|------|------|------|------|------|-----|-----|
| 1857 | N/A | 1911 | 1992 | 2074 | 2155 | 2236 | 2317 | 2398 | 2479 | 2560 | 2641 | N/A | N/A |

Open Back / Tight Seat & Back / 500 lb. Weight Capacity

TWO PLACE SOFA / URETHANE ARMS / ACCEPTS SEAT ON RIGHT

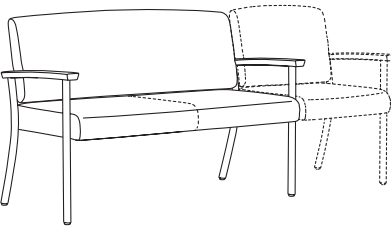

1950-C

Overall: 51.25"w 25.5"d 34"h **Arm:** 25"h **COM:** 3.5 yds.
Seat: 48"w 18.25"d 18.5"h **Weight:** 65 lbs. **COL:** n/a

| COM | COL | 1 | 2 | 3 | 4 | 5 | 6 | 7 | 8 | 9 | 10 | L1 | L2 |
|------|-----|------|------|------|------|------|------|------|------|------|------|-----|-----|
| 1857 | N/A | 1911 | 1992 | 2074 | 2155 | 2236 | 2317 | 2398 | 2479 | 2560 | 2641 | N/A | N/A |

Open Back / Tight Seat & Back / 500 lb. Weight Capacity

TWO PLACE SOFA / URETHANE ARMS / ACCEPTS TABLE ON RIGHT

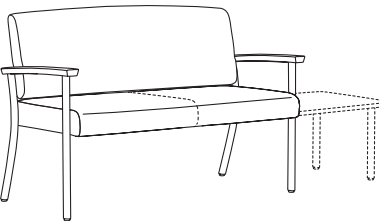

1950-T

Overall: 51.25"w 25.5"d 34"h **Arm:** 25"h **COM:** 3.5 yds.
Seat: 48"w 18.25"d 18.5"h **Weight:** 65 lbs. **COL:** n/a

| COM | COL | 1 | 2 | 3 | 4 | 5 | 6 | 7 | 8 | 9 | 10 | L1 | L2 |
|------|-----|------|------|------|------|------|------|------|------|------|------|-----|-----|
| 1857 | N/A | 1911 | 1992 | 2074 | 2155 | 2236 | 2317 | 2398 | 2479 | 2560 | 2641 | N/A | N/A |

Open Back / Tight Seat & Back / 500 lb. Weight Capacity

TWO PLACE SOFA / URETHANE ARMS / ACCEPTS TABLE ON LEFT

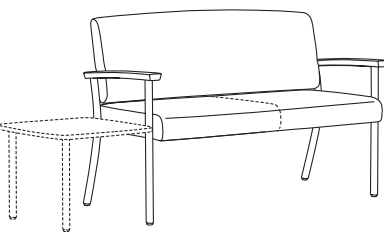

1950-LT

Overall: 51.25"w 25.5"d 34"h **Arm:** 25"h **COM:** 3.5 yds.
Seat: 48"w 18.25"d 18.5"h **Weight:** 65 lbs. **COL:** n/a

| COM | COL | 1 | 2 | 3 | 4 | 5 | 6 | 7 | 8 | 9 | 10 | L1 | L2 |
|------|-----|------|------|------|------|------|------|------|------|------|------|-----|-----|
| 1857 | N/A | 1911 | 1992 | 2074 | 2155 | 2236 | 2317 | 2398 | 2479 | 2560 | 2641 | N/A | N/A |

Open Back / Tight Seat & Back / 500 lb. Weight Capacity

DESCRIPTION:

- Upholstery Frames: Steel, Plywood & Hardwood
- Seat: High Density Polyurethane Foam Over Strap Webbing
- Back: High Density Polyurethane Foam Over Plywood
- Upholstered Covers: Stapled On Seat & Back
- Urethane Arm Caps - Standard
- Exposed Metal Legs: 14 Gauge Steel Tubing / Powder Coated (Wallsaver Back Legs)
- Leather Upholstery Not Available
- Adjustable Height Leveling Glides Standard
- 10 Year Warranty

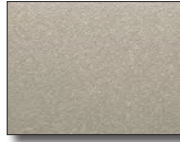

Leg Color: Champagne

OPTIONS:

- EPAC-1 Black Polyester Arm Caps (Set Of 2).....\$374
- AWAC-1 Wood Arm Caps (Set Of 2).....No Upcharge
- SSAC-2 Solid Surface Arm Caps (Set Of 2).....\$737
- RUC-G Removable Upholstery Covers \$100 Chair
- CC Contrasting Covers.....\$129

All Austen Components Are Field Replaceable.

NOTE: All Seating Configurations Are Viewed From Left To Right Facing. Please Attach A Layout Showing Seating Configuration w/ Your Order. Assembled Units Must Be Shipped In Configurations Of 3 Or Less.

TANDEM

ITEM #:

SPECIFICATIONS | GRADES | LIST PRICES:

TWO PLACE SOFA / URETHANE ARMS / ACCEPTS TABLE ON LEFT / SEAT ON RIGHT

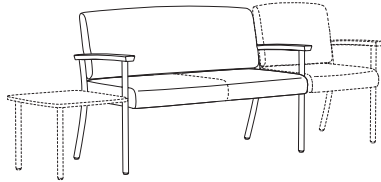

1950-TC

Overall: 51.25"w 25.5"d 34"h **Arm:** 25"h **COM:** 3.5 yds.
Seat: 48"w 18.25"d 18.5"h **Weight:** 65 lbs. **COL:** n/a

| COM | COL | 1 | 2 | 3 | 4 | 5 | 6 | 7 | 8 | 9 | 10 | L1 | L2 |
|------|-----|------|------|------|------|------|------|------|------|------|------|-----|-----|
| 1857 | N/A | 1911 | 1992 | 2074 | 2155 | 2236 | 2317 | 2398 | 2479 | 2560 | 2641 | N/A | N/A |

Open Back / Tight Seat & Back / 500 lb. Weight Capacity

TWO PLACE SOFA / URETHANE ARMS / ACCEPTS TABLE ON LEFT / RIGHT

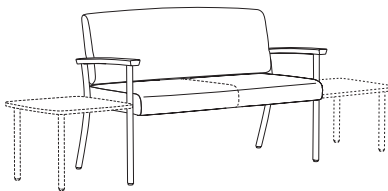

1950-TT

Overall: 51.25"w 25.5"d 34"h **Arm:** 25"h **COM:** 3.5 yds.
Seat: 48"w 18.25"d 18.5"h **Weight:** 65 lbs. **COL:** n/a

| COM | COL | 1 | 2 | 3 | 4 | 5 | 6 | 7 | 8 | 9 | 10 | L1 | L2 |
|------|-----|------|------|------|------|------|------|------|------|------|------|-----|-----|
| 1857 | N/A | 1911 | 1992 | 2074 | 2155 | 2236 | 2317 | 2398 | 2479 | 2560 | 2641 | N/A | N/A |

Open Back / Tight Seat & Back / 500 lb. Weight Capacity

DESCRIPTION:

- Upholstery Frames: Steel, Plywood & Hardwood
- Seat: High Density Polyurethane Foam Over Strap Webbing
- Back: High Density Polyurethane Foam Over Plywood
- Upholstered Covers: Stapled On Seat & Back
- Urethane Arm Caps - Standard
- Exposed Metal Legs: 14 Gauge Steel Tubing / Powder Coated (Wallsaver Back Legs)
- Leather Upholstery Not Available
- Adjustable Height Leveling Glides Standard
- 10 Year Warranty

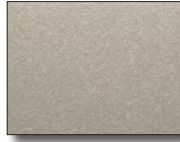

Leg Color: Champagne

OPTIONS:

- EPAC-1 Black Polyester Arm Caps (Set Of 2).....\$374
- AWAC-1 Wood Arm Caps (Set Of 2).....No Upcharge
- SSAC-2 Solid Surface Arm Caps (Set Of 2).....\$737
- RUC-G Removable Upholstery Covers \$100 Chair
- CC Contrasting Covers.....\$129

All Austen Components Are Field Replaceable.

NOTE: All Seating Configurations Are Viewed From Left To Right Facing. Please Attach A Layout Showing Seating Configuration w/ Your Order. Assembled Units Must Be Shipped In Configurations Of 3 Or Less.

TANDEM

ITEM #:

SPECIFICATIONS | GRADES | LIST PRICES:

TWO PLACE ADD-A-SEAT / URETHANE ARMS

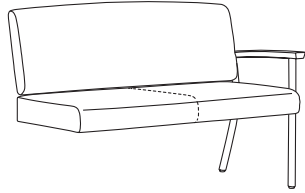

1951

Overall: 49.75"w 25.5"d 34"h **Arm:** 25"h **COM:** 3.5 yds.
Seat: 48"w 18.25"d 18.5"h **Weight:** 62 lbs. **COL:** n/a

| COM | COL | 1 | 2 | 3 | 4 | 5 | 6 | 7 | 8 | 9 | 10 | L1 | L2 |
|------|-----|------|------|------|------|------|------|------|------|------|------|-----|-----|
| 1883 | N/A | 1936 | 2017 | 2098 | 2179 | 2260 | 2341 | 2422 | 2504 | 2585 | 2666 | N/A | N/A |

Open Back / Tight Seat & Back / 500 lb. Weight Capacity

TWO PLACE ADD-A-SEAT / URETHANE ARMS / ACCEPTS SEAT ON RIGHT

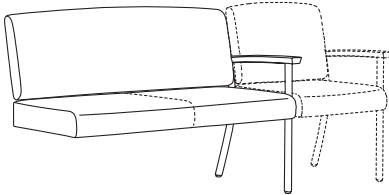

1951-C

Overall: 49.75"w 25.5"d 34"h **Arm:** 25"h **COM:** 3.5 yds.
Seat: 48"w 18.25"d 18.5"h **Weight:** 62 lbs. **COL:** n/a

| COM | COL | 1 | 2 | 3 | 4 | 5 | 6 | 7 | 8 | 9 | 10 | L1 | L2 |
|------|-----|------|------|------|------|------|------|------|------|------|------|-----|-----|
| 1883 | N/A | 1936 | 2017 | 2098 | 2179 | 2260 | 2341 | 2422 | 2504 | 2585 | 2666 | N/A | N/A |

Open Back / Tight Seat & Back / 500 lb. Weight Capacity

TWO PLACE ADD-A-SEAT / URETHANE ARMS / ACCEPTS TABLE ON RIGHT

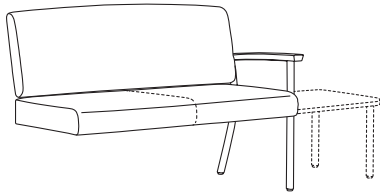

1951-T

Overall: 49.75"w 25.5"d 34"h **Arm:** 25"h **COM:** 3.5 yds.
Seat: 48"w 18.25"d 18.5"h **Weight:** 62 lbs. **COL:** n/a

| COM | COL | 1 | 2 | 3 | 4 | 5 | 6 | 7 | 8 | 9 | 10 | L1 | L2 |
|------|-----|------|------|------|------|------|------|------|------|------|------|-----|-----|
| 1883 | N/A | 1936 | 2017 | 2098 | 2179 | 2260 | 2341 | 2422 | 2504 | 2585 | 2666 | N/A | N/A |

Open Back / Tight Seat & Back / 500 lb. Weight Capacity

DESCRIPTION:

- High Pressure Laminate Over Plywood Core (Exposed Plywood Edge Is Tinted To Complement Top Laminate Color) *Optional Self-Edge Available
- Wilsonart Plastic Laminates Standard. Alternate Selections May Be Specified From Most Major Laminate Manufacturers. (Contact Factory For Availability)
- Exposed Metal Legs: 14 Gauge Steel Tubing / Powder Coated
- 10 Year Warranty

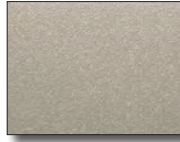

Leg Color: Champagne

OPTIONS:

- SE10W Self-Edge Table Top - 10"W x 22.5"D\$33
- SE20W Self-Edge Table Top - 20"W x 22.5"D\$38
- SE27W Self-Edge Table Top - 27.5"W x 27.5"D\$43

Specify Laminate (See Page 6)

NOTE: All Seating Configurations Are Viewed From Left To Right Facing. Please Attach A Layout Showing Seating Configuration w/ Your Order. Assembled Units Must Be Shipped In Configurations Of 3 Or Less.

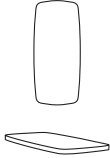
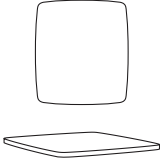
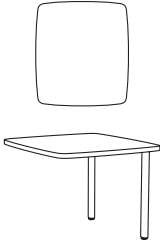
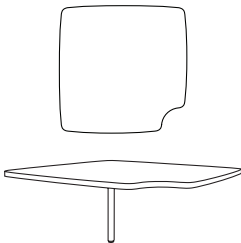
| CONNECTING TABLES | ITEM #: | SPECIFICATIONS GRADES LIST PRICES: | | | | | | | | | | | | |
|--|------------|---|-----|------------------------|---|---|---|---|---|---|---|---|----|----|
| <p>CONNECTING HALF TABLE</p>  | 19C1022-L | <i>Overall: 10"w 22.5"d 16"h</i> | | <i>Weight: 15 lbs.</i> | | | | | | | | | | |
| | | COM | COL | 1 | 2 | 3 | 4 | 5 | 6 | 7 | 8 | 9 | 10 | L1 |
| | | 417 High Pressure Laminate Over Plywood Core | | | | | | | | | | | | |
| <p>CONNECTING TABLE</p>  | 19C2022-L | <i>Overall: 20"w 22.5"d 16"h</i> | | <i>Weight: 20 lbs.</i> | | | | | | | | | | |
| | | COM | COL | 1 | 2 | 3 | 4 | 5 | 6 | 7 | 8 | 9 | 10 | L1 |
| | | 561 High Pressure Laminate Over Plywood Core | | | | | | | | | | | | |
| <p>CONNECTING END TABLE</p>  | 19E2022-L | <i>Overall: 20"w 22.5"d 16"h</i> | | <i>Weight: 22 lbs.</i> | | | | | | | | | | |
| | | COM | COL | 1 | 2 | 3 | 4 | 5 | 6 | 7 | 8 | 9 | 10 | L1 |
| | | 661 High Pressure Laminate Over Plywood Core | | | | | | | | | | | | |
| <p>CONNECTING CORNER TABLE</p>  | 19SC2727-L | <i>Overall: 27.5"w 27.5"d 16"h</i> | | <i>Weight: 40 lbs.</i> | | | | | | | | | | |
| | | COM | COL | 1 | 2 | 3 | 4 | 5 | 6 | 7 | 8 | 9 | 10 | L1 |
| | | 769 High Pressure Laminate Over Plywood Core | | | | | | | | | | | | |

DESCRIPTION:

- High Pressure Laminate Over Plywood Core (Exposed Plywood Edge Is Tinted To Complement Top Laminate Color) *Optional Self-Edge Available
- Wilsonart Plastic Laminates Standard. Alternate Selections May Be Specified From Most Major Laminate Manufacturers. (Contact Factory For Availability)
- Exposed Metal Legs: 14 Gauge Steel Tubing / Powder Coated
- 10 Year Warranty

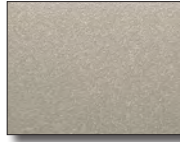

Leg Color: Champagne

OPTIONS:

- SE20W Self-Edge Table Top - 20"W x 22.5"D\$38
- SE42W Self-Edge Table Top - 27.5"W x 27.5"D\$47

Specify Laminate (See Page 6)

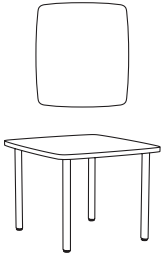
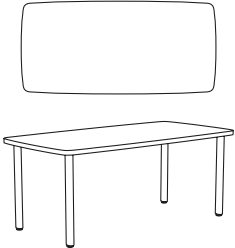
| TABLES | | ITEM #: | SPECIFICATIONS GRADES LIST PRICES: | | | | | | | | | | | | |
|--|--|----------|--|-----|---|------------------------|---|---|---|---|---|---|---|----|----|
| FREESTANDING END TABLE | | 192022-L | <i>Overall: 20"w 22.5"d 16"h</i> | | | <i>Weight: 25 lbs.</i> | | | | | | | | | |
|  | | | COM | COL | 1 | 2 | 3 | 4 | 5 | 6 | 7 | 8 | 9 | 10 | L1 |
| | | | 810 <i>High Pressure Laminate Over Plywood Core</i> | | | | | | | | | | | | |
| FREESTANDING COFFEE TABLE | | 194220-L | <i>Overall: 42"w 20"d 16"h</i> | | | <i>Weight: 45 lbs.</i> | | | | | | | | | |
|  | | | COM | COL | 1 | 2 | 3 | 4 | 5 | 6 | 7 | 8 | 9 | 10 | L1 |
| | | | 952 <i>High Pressure Laminate Over Plywood Core</i> | | | | | | | | | | | | |

| ARM CAPS / TOPS / COVERS | OPTION #: | SPECIFICATIONS LIST PRICES AVAILABILITY: |
|---|---------------|--|
| POLYESTER ARM CAPS | | <i>Overall: 2.75"w 22.5"d 1.125"h</i> |
|  | EPAC-1 | <p>\$374 (Set Of 2) POLYESTER <i>Black Polyester Arm Cap (Additional Colors Available)</i></p> <p><i>Available: Austen Guest / Tandem Collection</i></p> |
| WOOD ARM CAPS / SOLID SURFACE ARM CAPS | | <i>Overall: 2.75"w 22.5"d 1.125"h</i> |
|  | AWAC-1 | <p>NO UPCHARGE (Set Of 2) WOOD <i>Wood Arm Cap (Specify Finish)</i></p> <p><i>Available: Austen Guest / Tandem Collection</i></p> |
| | SSAC-2 | <p>\$737 (Set Of 2) SOLID SURFACE <i>White Solid Surface Arm Cap (Additional Colors Available - Call For Pricing)</i></p> <p><i>Available: Austen Guest / Tandem Collection</i></p> |
| REMOVABLE UPHOLSTERY COVERS - GUEST | | <i>Overall: N/A</i> |
|  | RUC-G | <p>\$100 LIST UPCHARGE PER GUEST CHAIR <i>Removable Upholstery Covers Attached w/ Velcro (Antimicrobial Moisture Barrier Fully Encapsulates All Foam Areas)</i></p> <p><i>Available: Austen Guest / Tandem Collection</i></p> |
| SELF EDGE TABLE TOP | | <i>Overall: 10"W x 22.5"D x .75"H / 20"W x 22.5"D x .75"H / 27.5"W x 27.5"D x .75"H</i> |
|  | SE10W | <p>\$33 (Self Edge Table Top - 10"W x 22.5"D) <i>High Pressure Laminate Top w/ Self Edge - Specify Laminate Color</i></p> |
| | SE20W | <p>\$38 (Self Edge Table Top - 20"W x 22.5"D) <i>High Pressure Laminate Top w/ Self Edge - Specify Laminate Color</i></p> |
| | SE27W | <p>\$43 (Self Edge Table Top - 27.5"W x 27.5"D) <i>High Pressure Laminate Top w/ Self Edge - Specify Laminate Color</i></p> |
| | SE42W | <p>\$47 (Self Edge Table Top - 42"W x 20"D) <i>High Pressure Laminate Top w/ Self Edge - Specify Laminate Color</i></p> <p><i>Available: Austen Table Collection</i></p> |
| CONTRASTING COVERS | | <i>Overall: N/A</i> |
|  | CC | <p>\$129</p> <p><i>NOTE: If Two Or More Upholsteries Or Leathers Are Used On Any Piece Of Furniture, Then A Contrast Charge Will Apply Per Order. When Using Trinity Upholstery, The Higher Priced Upholstery Grade Will Be Used In Pricing, Unless It's Trinity Leather With Fabric Contrast Welt, Or COM With Trinity Contrast Welt, Then Contact Customer Service For Pricing.</i></p> <p><i>Available: Austen Guest / Tandem Collection</i></p> |

Serene

CHESTS / BEDSIDE CABINETS /
WARDROBES / OVER-THE-BED TABLE

Effective: March 1, 2025

T R I N I T Y

Date:

Page:

Modification:

Description:

Casegoods Laminates

Due to variations in screen displays, digital laminate images shown here may not match actual laminate samples exactly. These images are for color reference only. If you require an actual laminate sample, please contact your representative or contact customer service.

Laminates For Casegoods (Serene Collection)



Wilsonart
Fusion Maple

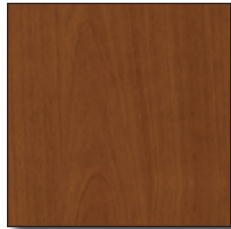

Wilsonart
Blitmore Cherry

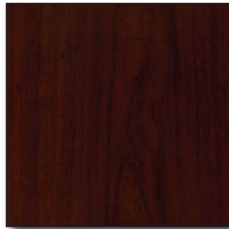

Wilsonart
Empire Mahogany

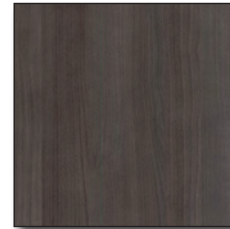

Wilsonart
Skyline Walnut



Wilsonart
Ebony

NOTE: Serene chassis are TFL with matching HPL top option. Additional colors available. Please contact Customer Service for more information.

Laminates For Over-The-Bed Table Top (Serene Collection)



Nevamar
Clear Maple



Wilsonart
Fusion Maple



Wilsonart
Quartered Oak



Wilsonart
Bannister Oak



Wilsonart
Solar Oak



Wilsonart
Nepal Teak

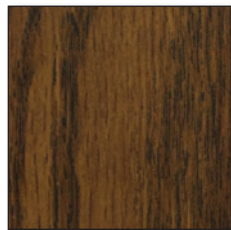

Wilsonart
English Oak

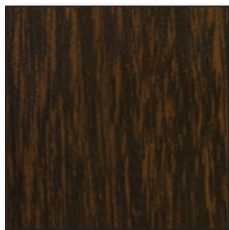

Wilsonart
Gunstock Walnut

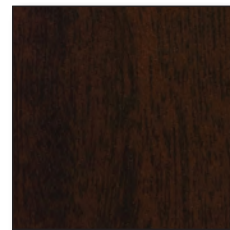

Wilsonart
Figured Mahogany



Wilsonart
Wild Cherry

NOTE: Over-The-Bed Table top laminates are available in (10) standard colors, including Fusion Maple. Blitmore Cherry, Empire Mahogany, Skyline Walnut, and Ebony laminates are available as an upcharge. Additional colors and top options available. Please contact Customer Service for more information.

Metal Base Finish For Over-The-Bed Table (Serene Collection)

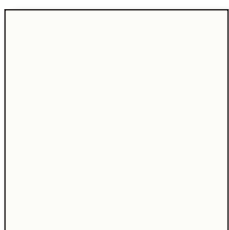

Opal - Standard

NOTE: Over-The-Bed Table metal base is standard in Opal powder coat finish. Other metal base colors are available as an upcharge with qualifying quantities. Please contact customer service for more information.

Pull Selections

Trinity offers (3) pull selections for the Serene Collection.

P02 Bow Pull - Matte Black Finish (STANDARD PULL)

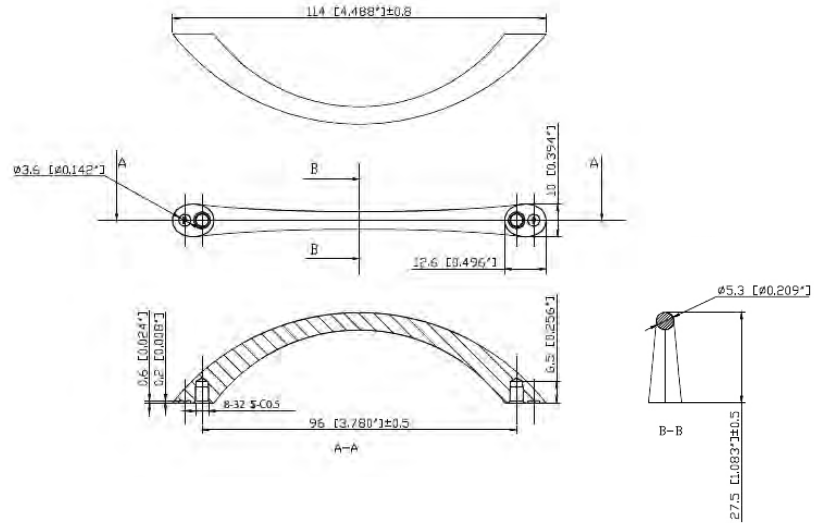

P03 Bow Pull - Brushed Nickel Finish (OPTIONAL PULL - NO UPCHARGE)

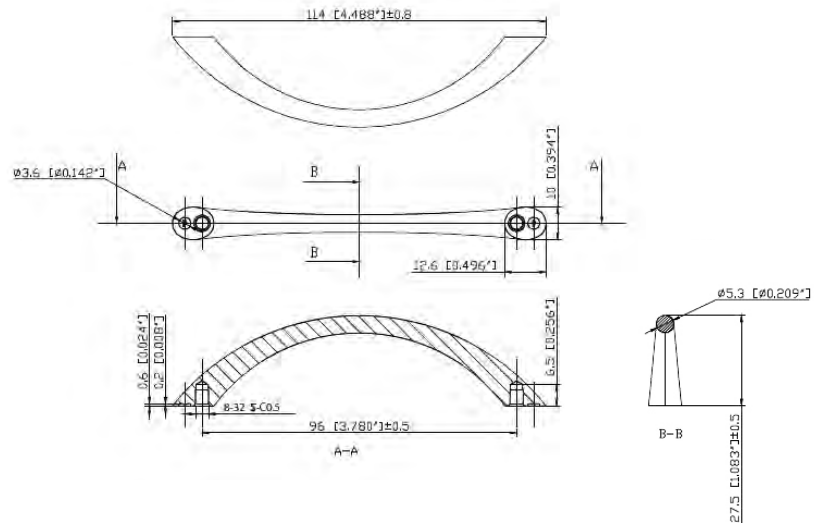

P01 Bar Pull - Brushed Nickel Finish (OPTIONAL PULL - NO UPCHARGE)

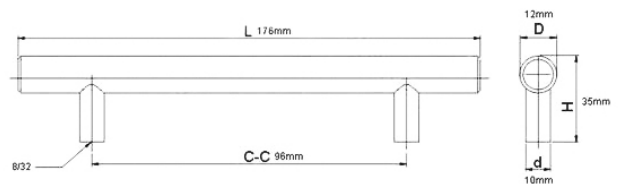



DESCRIPTION:

- PVC Banded HPL Top Standard
- TFL Chassis Construction w/ Matching 1mm PVC Edges
- White Vinyl Wrapped Drawers
- HD Full Extension Ball Bearing Side Guides
- P02 Matte Black Bow Pull Standard
- Plinth Base Standard
- Tack Glides On Plinth Bases
- Locking Top Drawer (Std. On Drawers)
- Vented Back Panel w/ Black Plastic Wire Grommet
- 10 Year Warranty

OPTIONS:

- P01 Brushed Nickel Bar Pull (See Serene Hardware Page)..... n/c
- P03 Brushed Nickel Bow Pull (See Serene Hardware Page)..... n/c
- MLB 2" Dia. x 4" h Matte Black Metal Legs (Set Of 4) \$153
- MLN 2" Dia. x 4" h Nickel Metal Legs (Set Of 4) \$153
- TDPT-1 Thermofoil Drip Proof Top (Chests) Call For Pricing
- SDPT-1 Solid Surface Drip Proof Top (Chests) Call For Pricing
- RDL-1 Removable Drawer Liner (1 Per Drawer - Chests) Call For Pricing

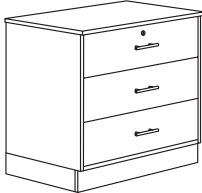
Specify Laminate Color (See Serene Casegoods Laminates Page)



| CHESTS | ITEM #: | SPECIFICATIONS LIST PRICES: |
|---|----------------------|--|
| <p>3 DRAWER CHEST</p>  | <p>61-128</p> | <p>Overall: 33.5"w 21.5"d 30"h Weight: 110 lbs.</p> <p>LIST PRICE</p> <hr/> <p>1817 <i>PVC Banded HPL Top / Plinth Base</i></p> |
| <p>4 DRAWER CHEST</p>  | <p>61-152</p> | <p>Overall: 33.5"w 21.5"d 38"h Weight: 132 lbs.</p> <p>LIST PRICE</p> <hr/> <p>2178 <i>PVC Banded HPL Top / Plinth Base</i></p> |

DESCRIPTION:

- PVC Banded HPL Top Standard
- TFL Chassis Construction w/ Matching 1mm PVC Edges
- White Vinyl Wrapped Drawers
- HD Full Extension Ball Bearing Side Guides (Drawers Only)
- P02 Matte Black Bow Pull Standard
- Plinth Base Standard
- Tack Glides On Plinth Bases
- European Concealed Hinges, 90° Opening (Doors Only)
- Locking Top Drawer (Std. On Drawers)
- Vented Back Panel w/ Black Plastic Wire Grommet
- 10 Year Warranty

OPTIONS:

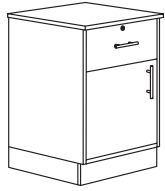
- P01 Brushed Nickel Bar Pull (See Serene Hardware Page)..... n/c
 - P03 Brushed Nickel Bow Pull (See Serene Hardware Page)..... n/c
 - CAS-NL Non-Locking Swivel Casters (Set Of 2) \$305
 - CAS-L Locking Swivel Casters (Set Of 2) \$305
 - MLB 2"Dia. x 4"h Matte Black Metal Legs (Set Of 4) \$153
 - MLN 2"Dia. x 4"h Nickel Metal Legs (Set Of 4) \$153
 - TDPT-2 Thermofoil Drip Proof Top (Bedside Cabinets) Call For Pricing
 - SDPT-2 Solid Surface Drip Proof Top (Bedside Cabinets) Call For Pricing
 - RDL-2 Removable Drawer Liner (1 Per Drawer - Bedside Cabinets) \$127
 - DOL Drawer/Door Lock (61-232 / 61-801 / 61-803)..... \$135
- Specify Laminate Color (See Serene Casegoods Laminates Page)

| BEDSIDE CABINETS | ITEM #: | SPECIFICATIONS LIST PRICES: |
|--|----------------------|---|
| <p>1 DRAWER BEDSIDE CABINET</p>  | <p>61-222</p> | <p>Overall: 17"w 21.5"d 30"h Weight: 60 lbs.</p> <p>LIST PRICE</p> <hr/> <p>1372 <i>PVC Banded HPL Top / Plinth Base</i></p> |
| <p>1 DOOR / 1 DRAWER BEDSIDE CABINET</p>  | <p>61-232</p> | <p>Overall: 21.5"w 21.5"d 30"h Weight: 75 lbs.</p> <p>LIST PRICE</p> <hr/> <p>1440 <i>PVC Banded HPL Top / Plinth Base</i></p> |
| <p>3 DRAWER BEDSIDE CABINET</p>  | <p>61-233</p> | <p>Overall: 17"w 21.5"d 30"h Weight: 70 lbs.</p> <p>LIST PRICE</p> <hr/> <p>1646 <i>PVC Banded HPL Top / Plinth Base</i></p> |

DESCRIPTION:

- TFL Chassis Construction w/ Matching 1mm PVC Edges
- White Vinyl Wrapped Drawer (61-803)
- HD Full Extension Ball Bearing Side Guides (61-803 Drawer Only)
- P02 Matte Black Bow Pull Standard
- Full Width Metal Coat Rod
- Adjustable Shelf (61-801)
- Plinth Base Standard
- Tack Glides On Plinth Bases
- European Concealed Hinges, 90° Opening (Doors Only)
- Vented Back Panel w/ Black Plastic Wire Grommet
- 10 Year Warranty

OPTIONS:

- P01 Brushed Nickel Bar Pull (See Serene Hardware Page)..... n/c
- P03 Brushed Nickel Bow Pull (See Serene Hardware Page)..... n/c
- DOL Drawer/Door Lock (61-232 / 61-801 / 61-803)..... \$135
- RDL-3 Removable Drawer Liner (1 Per Drawer - 61-803 Only)..... Call For Pricing

Specify Laminate Color (See Serene Casegoods Laminates Page)

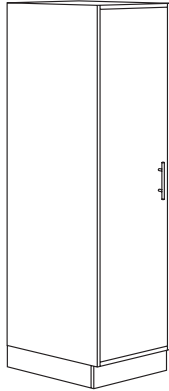
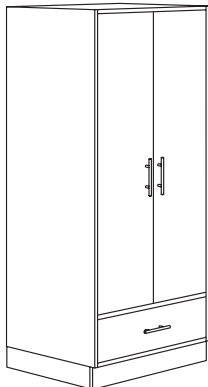
| WARDROBES | ITEM #: | SPECIFICATIONS LIST PRICES: |
|--|---------------|---|
| <p>HALF WARDROBE</p>  | <p>61-801</p> | <p>Overall: 20"w 25"d 71.25"h Weight: 120 lbs.</p> <hr/> <p>LIST PRICE</p> <hr/> <p>2435 <i>Full Width Coat Rod / Adjustable Shelf / Plinth Base</i></p> |
| <p>FULL WARDROBE WITH 1 DRAWER</p>  | <p>61-803</p> | <p>Overall: 32"w 25"d 71.25"h Weight: 220 lbs.</p> <hr/> <p>LIST PRICE</p> <hr/> <p>2743 <i>Full Width Coat Rod / Bottom Drawer (Non-Locking Std.) / Plinth Base</i></p> |

DESCRIPTION:

(Over-The-Bed Table: 61-4828)

- PVC Banded HPL Top Standard
- 40mm Dual Wheel Casters
- Pneumatic Height Adjustment
- Opal Powder Coat Finish Standard

(STOOLS: 61-1619 / 61-2419)

- 5 Star Nylon Base w/ Casters
- Non-Tilting Control / Pneumatic Seat Height Adjustment
- Seat / Back: High Density Polyurethane Foam Over Plywood

OPTIONS:

- TDPT-3 Thermofoil Drip Proof Top (Over-The-Bed Table Top) Call For Pricing
- SDPT-3 Solid Surface Drip Proof Top (Over-The-Bed Table Top) Call For Pricing

Specify Top Laminate Color (See Serene Casegoods Laminates Page)

OVER-THE-BED TABLE / STOOLS

ITEM #:

SPECIFICATIONS | LIST PRICES:

OVER-THE-BED TABLE

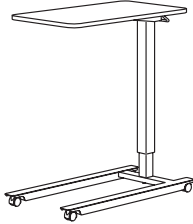

61-4828

Overall: 35"w 18"d 25.5"h - 41.25"h
Weight: 30 lbs.

LIST PRICE

1252

PVC Banded HPL Top / Fork Style Base / Pneumatic Height Adjustment

**PHYSICIAN STOOL W/
FULLY UPHOLSTERED ROUND SEAT**

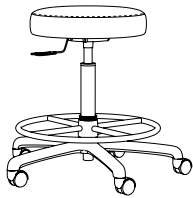

61-1619

Overall: 16"w 16"d 24"h - 30"h
Seat: 16"w 16"d 24"h - 30"h

Arm: n/a
Weight: 25 lbs.

COM: .75 yds.
COL: 13.5

| COM | COL | 1 | 2 | 3 | 4 | 5 | 6 | 7 | 8 | 9 | 10 | L1 | L2 |
|-----|-----|-----|-----|-----|-----|-----|-----|-----|-----|-----|-----|-----|-----|
| 497 | 547 | 520 | 531 | 542 | 554 | 565 | 576 | 587 | 598 | 610 | 621 | 645 | 685 |

5 Star Nylon Base w/ Casters / Non-Tilting Control / Pneumatic Seat Height Adjustment

**PHYSICIAN STOOL W/
FULLY UPHOLSTERED SEAT & BACK**

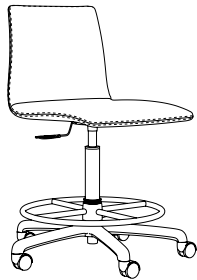

61-2419

Overall: 18"w 22.25"d 35.75"h - 41.75"h
Seat: 18"w 17.5"d 22.25"h - 28.25"h

Arm: n/a
Weight: 25 lbs.

COM: 1.5 yds.
COL: 27 sq.ft.

| COM | COL | 1 | 2 | 3 | 4 | 5 | 6 | 7 | 8 | 9 | 10 | L1 | L2 |
|-----|-----|-----|-----|-----|-----|-----|------|------|------|------|------|------|------|
| 858 | 944 | 868 | 896 | 924 | 952 | 980 | 1008 | 1036 | 1064 | 1092 | 1120 | 1170 | 1271 |

5 Star Nylon Base w/ Casters / Non-Tilting Control / Pneumatic Seat Height Adjustment

| LEGS / CASTERS / LOCK / TOPS | OPTION #: | SPECIFICATIONS LIST PRICES AVAILABILITY: |
|---|---|--|
| <p>METAL LEGS</p>  <p>MLN</p>  <p>MLB</p> | <p>Overall: 2"dia 4"h</p> <hr/> <p>MLN \$153 (Set Of 4) <i>Nickel Metal Legs</i></p> <p>MLB \$153 (Set Of 4) <i>Matte Black Metal Legs</i></p> <p>Available: Serene Chests & Bedside Cabinets</p> | |
| <p>CASTERS</p>  <p>CAS-NL</p>  <p>CAS-L</p> | <p>Overall: 3"dia 2"w 4"h</p> <hr/> <p>CAS-NL \$305 (Set Of 2) <i>Non-Locking Swivel Gray & Silver Plastic Casters</i></p> <p>CAS-L \$305 (Set Of 2) <i>Locking Swivel Gray & Silver Plastic Casters</i></p> <p>Available: Serene Bedside Cabinets</p> | |
| <p>DRAWER / DOOR LOCK</p>  | <p>Overall: 7/8" dia</p> <hr/> <p>DOL \$127 (Per Lock) <i>Black Metal Drawer / Door Lock</i></p> <p>Available: Serene 61-232, 61-801, 61-803</p> | |
| <p>THERMOFOIL DRIP PROOF TOP</p>  | <p>Overall: Per Top Size</p> <hr/> <p>TDPT-1 CALL FOR PRICING (Top For Chest) <i>TFL Thermofoil Drip Proof Top - Specify Color</i></p> <p>TDPT-2 CALL FOR PRICING (Top For Bedside Cabinet) <i>TFL Thermofoil Drip Proof Top - Specify Color</i></p> <p>TDPT-3 CALL FOR PRICING (Top For Over-The-Bed Table) <i>TFL Thermofoil Drip Proof Top - Specify Color</i></p> <p>Available: Serene Chests, Bedside Cabinets & Over-The-Bed Table</p> | |

| TOPS / DRAWER LINERS | OPTION #: | SPECIFICATIONS LIST PRICES AVAILABILITY: |
|---|--|--|
| <p>SOLID SURFACE DRIP PROOF TOP</p>  | <p><i>Overall: Per Top Size</i></p> <hr/> <p>SDPT-1 CALL FOR PRICING (Top For Chest) <i>Solid Surface Drip Proof Top - Standard In White (Additional Colors Available)</i></p> <p>SDPT-2 CALL FOR PRICING (Top For Bedside Cabinet) <i>Solid Surface Drip Proof Top - Standard In White (Additional Colors Available)</i></p> <p>SDPT-3 CALL FOR PRICING (Top For Over-The-Bed Table) <i>Solid Surface Drip Proof Top - Standard In White (Additional Colors Available)</i></p> <p><i>Available: Serene Chests, Bedside Cabinets & Over-The-Bed Table</i></p> | |
| <p>REMOVABLE PLASTIC DRAWER LINERS</p> | <p><i>Overall: Per Drawer Size</i></p> <hr/> <p>RDL-1 CALL FOR PRICING (1 Liner Per Drawer - Chest) <i>Removable Plastic Drawer Liner - Black Color</i></p> <p>RDL-2 \$133 (1 Liner Per Drawer - Bedside Cabinet) <i>Removable Plastic Drawer Liner - Black Color</i></p> <p>RDL-3 CALL FOR PRICING (1 Liner Per Drawer - Full Wardrobe) <i>Removable Plastic Drawer Liner - Black Color</i></p> <p><i>Available: Serene Chests, Bedside Cabinets & Full Wardrobe</i></p> | |

Jewel

DINING CHAIRS

Effective: March 1, 2025

T R I N I T Y

Date:

Page:

Modification:

Description:

DESCRIPTION:

- Upholstery Frames: Steel, Plywood & Hardwood
- Removable Seat: High Density Polyurethane Foam Over Sheet Webbing
- Back: High Density Polyurethane Foam Over Contoured Curved Plywood Back
- Upholstered Covers On Seat & Back: Attached w/ Velcro / Removable For Maintenance
- Antimicrobial Moisture Barrier Fully Encapsulates All Foam Areas On Seat & Back
- Double Needle Stitching Standard
- Leather Upholstery Available
- 10 Year Warranty

OPTIONS:

- RPAC-3 Black Polyester Arm Caps For M109/M110\$173
- NT-1 Brass Nail Head Trim\$78
- C1 Carpet Casters - 2" Metal Balls (Set Of 2 - Front Legs Only)\$228
- CC Contrasting Covers\$129

Specify Exposed Wood Finish (See Page 6)

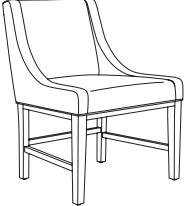
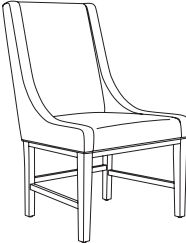
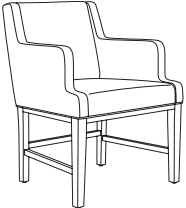
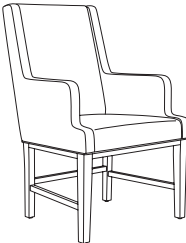
| DINING CHAIRS | | ITEM #: | SPECIFICATIONS GRADES LIST PRICES: | | | | | | | | | | | | | |
|---|--|--------------------|--|------|------|-------------------------------|------|------|------------------------------|------|------|------|------|------|------|------|
|  | <p>LOW BACK DINING CHAIR - ARMLESS</p> | <p>M101</p> | <p>Overall: 25.25"w 24"d 33"h</p> | | | <p>Arm: n/a</p> | | | <p>COM: 2 yds.</p> | | | | | | | |
| | | | <p>Seat: 21.25"w 17.25"d 19"h</p> | | | <p>Weight: 65 lbs.</p> | | | <p>COL: 36 sq.ft.</p> | | | | | | | |
| | | | COM | COL | 1 | 2 | 3 | 4 | 5 | 6 | 7 | 8 | 9 | 10 | L1 | L2 |
| | | | | | | | | | | | | | | | | |
| | | | 822 | 904 | 868 | 913 | 959 | 1004 | 1049 | 1095 | 1140 | 1185 | 1231 | 1276 | 1340 | 1503 |
| <p><i>Tight Seat & Back / 350 lb. Weight Capacity</i></p> | | | | | | | | | | | | | | | | |
|  | <p>HIGH BACK DINING CHAIR - ARMLESS</p> | <p>M103</p> | <p>Overall: 25.25"w 26.25"d 39.25"h</p> | | | <p>Arm: n/a</p> | | | <p>COM: 2.5 yds.</p> | | | | | | | |
| | | | <p>Seat: 21.25"w 17.25"d 19"h</p> | | | <p>Weight: 70 lbs.</p> | | | <p>COL: 45 sq.ft.</p> | | | | | | | |
| | | | COM | COL | 1 | 2 | 3 | 4 | 5 | 6 | 7 | 8 | 9 | 10 | L1 | L2 |
| | | | | | | | | | | | | | | | | |
| | | | 857 | 943 | 921 | 976 | 1031 | 1085 | 1140 | 1195 | 1249 | 1304 | 1359 | 1414 | 1486 | 1683 |
| <p><i>Tight Seat & Back / 350 lb. Weight Capacity</i></p> | | | | | | | | | | | | | | | | |
|  | <p>LOW BACK DINING CHAIR - ARMED</p> | <p>M104</p> | <p>Overall: 25.25"w 24"d 33"h</p> | | | <p>Arm: 26"h</p> | | | <p>COM: 3 yds.</p> | | | | | | | |
| | | | <p>Seat: 21.25"w 17.25"d 19"h</p> | | | <p>Weight: 70 lbs.</p> | | | <p>COL: 54 sq.ft.</p> | | | | | | | |
| | | | COM | COL | 1 | 2 | 3 | 4 | 5 | 6 | 7 | 8 | 9 | 10 | L1 | L2 |
| | | | | | | | | | | | | | | | | |
| | | | 882 | 971 | 970 | 1038 | 1106 | 1174 | 1242 | 1310 | 1378 | 1446 | 1514 | 1582 | 1668 | 1913 |
| <p><i>Tight Seat & Back / 350 lb. Weight Capacity</i></p> | | | | | | | | | | | | | | | | |
|  | <p>HIGH BACK DINING CHAIR - ARMED</p> | <p>M106</p> | <p>Overall: 25.25"w 26.25"d 39.25"h</p> | | | <p>Arm: 26"h</p> | | | <p>COM: 3.5 yds.</p> | | | | | | | |
| | | | <p>Seat: 21.25"w 17.25"d 19"h</p> | | | <p>Weight: 75 lbs.</p> | | | <p>COL: 63 sq.ft.</p> | | | | | | | |
| | | | COM | COL | 1 | 2 | 3 | 4 | 5 | 6 | 7 | 8 | 9 | 10 | L1 | L2 |
| | | | | | | | | | | | | | | | | |
| | | | 953 | 1048 | 1056 | 1132 | 1209 | 1286 | 1362 | 1439 | 1515 | 1592 | 1668 | 1745 | 1841 | 2117 |
| <p><i>Tight Seat & Back / 350 lb. Weight Capacity</i></p> | | | | | | | | | | | | | | | | |

DESCRIPTION:





- Upholstery Frames: Hardwood & Plywood
- Seat: High Density Polyurethane Foam Over Woven Rubber Webbing
- Back: High Density Polyurethane Foam Over Polypropylene Webbing
- Exposed Arms: M107 Arms Are Solid Steam Bent Cherry
- Double Needle Stitching Standard
- Leather Upholstery Available
- 10 Year Warranty

OPTIONS:

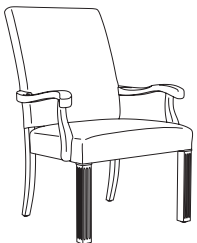
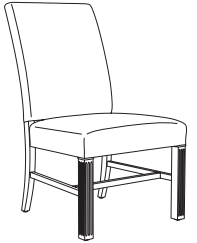
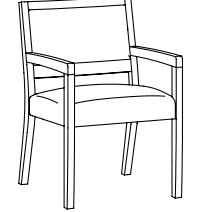
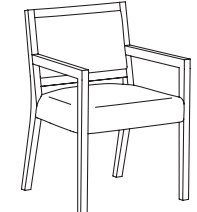
- RPAC-3 Black Polyester Arm Caps For M109/M110 (Set Of 2)\$173
- NT-1 Brass Nail Head Trim\$78
- C1 Carpet Casters - 2" Metal Balls (Set Of 2 - Front Legs Only)\$228
- CC Contrasting Covers\$129

Specify Exposed Wood Finish (See Page 6)

| DINING CHAIRS | | ITEM #: | SPECIFICATIONS GRADES LIST PRICES: | | | | | | | | | | | | | |
|--|---|---------|--|------|------------------|------|----------------|------|------|------|------|------|------|------|------|------|
|  | TRADITIONAL DINING CHAIR - ARMED | M107 | Overall: 27.75"w 27.25"d 38.5"h | | Arm: 25"h | | COM: 2.75 yds. | | | | | | | | | |
| | Seat: 21.5"w 18.5"d 18.5"h | | Weight: 45 lbs. | | COL: 49.5 sq.ft. | | | | | | | | | | | |
| | COM | | COL | 1 | 2 | 3 | 4 | 5 | 6 | 7 | 8 | 9 | 10 | L1 | L2 | |
| | | | 1287 | 1416 | 1412 | 1474 | 1537 | 1599 | 1661 | 1724 | 1786 | 1848 | 1911 | 1973 | 2060 | 2285 |
| Tight Seat & Back / 350 lb. Weight Capacity | | | | | | | | | | | | | | | | |
|  | TRADITIONAL DINING CHAIR - ARMLESS | M108 | Overall: 22.5"w 27.25"d 38.5"h | | Arm: n/a | | COM: 2.75 yds. | | | | | | | | | |
| | Seat: 22.5"w 18.5"d 18.5"h | | Weight: 40 lbs. | | COL: 49.5 sq.ft. | | | | | | | | | | | |
| | COM | | COL | 1 | 2 | 3 | 4 | 5 | 6 | 7 | 8 | 9 | 10 | L1 | L2 | |
| | | | 952 | 1047 | 1076 | 1139 | 1201 | 1263 | 1326 | 1388 | 1450 | 1513 | 1575 | 1637 | 1724 | 1948 |
| Tight Seat & Back / 350 lb. Weight Capacity | | | | | | | | | | | | | | | | |
|  | OPEN ARM / OPEN BACK DINING CHAIR (REPLAY 1522) | M109 | Overall: 22"w 24"d 33"h | | Arm: 25"h | | COM: 2 yds. | | | | | | | | | |
| | Seat: 19.5"w 19"d 18.5"h | | Weight: 28 lbs. | | COL: 36 sq.ft. | | | | | | | | | | | |
| | COM | | COL | 1 | 2 | 3 | 4 | 5 | 6 | 7 | 8 | 9 | 10 | L1 | L2 | |
| | | | 1014 | 1115 | 1059 | 1110 | 1160 | 1211 | 1261 | 1312 | 1362 | 1413 | 1463 | 1514 | 1581 | 1763 |
| Wallsaver / Upholstered Outside Back / Plain Seat / Removable Upholstery / 350 lb. Weight Capacity | | | | | | | | | | | | | | | | |
|  | OPEN ARM / OPEN WOOD BACK DINING CHAIR (EDGE 385) | M110 | Overall: 22"w 24"d 33"h | | Arm: 25"h | | COM: 1.25 yds. | | | | | | | | | |
| | Seat: 19.5"w 17.75"d 18.75"h | | Weight: 17 lbs. | | COL: 23 sq.ft. | | | | | | | | | | | |
| | COM | | COL | 1 | 2 | 3 | 4 | 5 | 6 | 7 | 8 | 9 | 10 | L1 | L2 | |
| | | | 962 | 1058 | 973 | 992 | 1019 | 1047 | 1074 | 1102 | 1129 | 1157 | 1184 | 1212 | 1249 | 1348 |
| Wood Back / Tight Seat & Back / 350 lb. Weight Capacity | | | | | | | | | | | | | | | | |

| ARM CAPS / CASTERS / COVERS | OPTION #: | SPECIFICATIONS LIST PRICES AVAILABILITY: |
|--|----------------------|---|
| <p>POLYESTER ARM CAPS</p>  <p>RPAC-3 Polyester Arm Cap</p> | <p>RPAC-3</p> | <p>Overall: 3.625"w 30.25"d .5"h</p> <hr/> <p>\$173 (Set Of 2) <i>Black Polyester Arm Cap (Additional Colors Available)</i></p> <p>Available: M109 / M110 - Jewel Collection</p> |
| <p>NAIL HEAD TRIM</p>  | | <p>Overall: .4375" Diameter</p> <hr/> <p>NT-1 \$78 - Guest Chair <i>#9 French Natural Brass Standard. Pewter Nail Trim Is Available. (Specify Finish) NOTE: All Trim Is Placed Head To Head..</i></p> <p>Available: Jewel Collection</p> |
| <p>CASTERS</p>  <p>(C1) Carpet Caster - 2" Metal Balls</p> | <p>C1</p> | <p>Overall: 2"h</p> <hr/> <p>\$228 (Set Of 2 - Front Legs Only) <i>Carpet Caster - 2" Metal Balls - Antique Windsor (Additional Finishes Available)</i></p> <p>Available: Jewel Collection</p> |
| <p>CONTRASTING COVERS</p>  | <p>CC</p> | <p>Overall: N/A</p> <hr/> <p>\$129 <i>NOTE: If Two Or More Upholsteries Or Leathers Are Used On Any Piece Of Furniture, Then A Contrast Charge Will Apply Per Order. When Using Trinity Upholstery, The Higher Priced Upholstery Grade Will Be Used In Pricing, Unless It's Trinity Leather With Fabric Contrast Welt, Or COM With Trinity Contrast Welt, Then Contact Customer Service For Pricing.</i></p> <p>Available: Jewel Collection</p> |

FACELIFT

COLLECTION

PRICE LIST • MARCH 1, 2025

T R I N I T Y

FACELIFT FEATURES

ALL PRODUCTS ARE MODULAR, REPLACEABLE, RECYCLABLE AND RENEWABLE. ALL UPHOLSTERY ATTACHES WITH VELCRO BRAND HOOK AND LOOP FASTENERS. NO TOOLS ARE NEEDED TO RENEW ANY UPHOLSTERY COMPONENTS. SIMPLY PEEL OFF AND REPLACE. SAFE-T-GUARD® ANTIMICROBIAL WOOD FINISH TOP COAT IS STANDARD ON EXPOSED WOOD. ANTIMICROBIAL BARRIER FULLY ENCAPSULATES THE SEAT, BACK AND ARMS. THE HYBRID FRAME IS MADE FROM RECYCLED STEEL, FSC APPROVED HARDWOOD AND PLYWOOD. SELECTED BARIATRIC MODELS ARE RATED 500 TO 1000 POUNDS. ALL MAINTENANCE CAN BE PERFORMED TOTALLY ON-SITE. ALL COMPONENTS CAN BE REPLACED INDEPENDENTLY, INCLUDING:

- UPHOLSTERY COVERS
- SEAT AND BACK CUSHIONS
- SEAT SUSPENSION SYSTEM
- ALL FRAME COMPONENTS

FLAMMABILITY

UNLESS OTHERWISE SPECIFIED, FOAM USED IN ALL TRINITY FURNITURE INCORPORATED SEATING PRODUCTS COMPLIES WITH CALIFORNIA TECHNICAL BULLETIN 117. PLEASE CONTACT CUSTOMER SUPPORT IF COMPLIANCE IS REQUIRED FOR THE OTHER FIRE CODES. INCLUDING:

BOSTON FIRE CODE**CALIFORNIA TECHNICAL BULLETIN 133****NEW YORK PORT AUTHORITY****SPECIFICATIONS**

UPHOLSTERY FRAMES ARE PLYWOOD AND HARDWOOD. STEEL SEAT FRAME. SEAT IS HIGH DENSITY POLYURETHANE OVER RUBBER WOVEN POLYPROPYLENE STRAPS. BACK IS HIGH DENSITY POLYURETHANE OVER SINUOUS WIRE. ANTI-MICROBIAL MOISTURE BARRIER STANDARD. EXPOSED WOOD IS SOLID MAPLE. ALL ITEMS ARE PRODUCED TO PRICE LIST SPECIFICATIONS. WE RESERVE THE RIGHT TO MAKE MODIFICATIONS AND IMPROVEMENTS WITHOUT PRIOR NOTICE. ALL DIMENSIONS SHOWN ARE APPROXIMATE AND MAY VARY DUE TO COVER BEING USED.

FACELIFT WARRANTY

TRINITY WARRANTS ALL FACELIFT PRODUCTS FOR THE LIFE OF THE PRODUCT AGAINST MANUFACTURING AND FACTORY DEFECTS, EXCLUDING COVERING MATERIALS, UNDER NORMAL SINGLE SHIFT SERVICE FOR ORIGINAL PURCHASER. DURING THIS PERIOD TRINITY FURNITURE, AT OUR OPTION, WILL REPLACE, REPAIR OR RETURN THE PURCHASE PRICE OF ANY MERCHANDISE THAT, UPON OUR INSPECTION, IS DEEMED TO BE DEFECTIVE, THIS CONSTITUTES THE SOLE AND EXCLUSIVE REMEDY TO THE CUSTOMER. DAMAGES, RESULTING FROM FREIGHT, CLAIMED OR UNCLAIMED, FROM ACCIDENT, ALTERATION, TAMPERING, MISUSE, NEGLIGENCE OR ABUSE VOIDS THIS WARRANTY. IN THE EVENT ANY PRODUCT HAS TO BE RETURNED TO THE FACTORY FOR VERIFICATION OF A COMPLAINT, IT MUST BE SHIPPED PREPAID AND INCLUDE WRITTEN INFORMATION CONTAINING THE NAME OF THE ORIGINAL PURCHASER, ORIGINAL INVOICE NUMBER, AND A COPY OF THE ORIGINAL PURCHASE ORDER MUST BE PROVIDED. BECAUSE OF NATURAL VARIATIONS ON MATERIALS OVER WHICH TRINITY FURNITURE INC HAS NO CONTROL, THIS WARRANTY DOES NOT EXTEND TO COLOR, GRAIN, OR TEXTURE OF WOOD, OR UPHOLSTERY COVER. THIS WARRANTY IS APPLICABLE ONLY TO THOSE PARTS ACTUALLY MANUFACTURED BY TRINITY FURNITURE. FOR PURCHASED COMPONENT PARTS, WE WILL APPLY EXACTLY THE SAME WARRANTY THIS IS EXTENDED TO US BY OUR SUPPLIER. TRINITY FURNITURE SHALL NOT BE LIABLE FOR CONSEQUENTIAL OR INCIDENTAL DAMAGES ARISING FROM ANY PRODUCT DEFECT.

MADE IN AMERICA

ALL FURNITURE IS PROUDLY MADE IN THE UNITED STATES OF AMERICA.

ENVIRONMENTAL SUSTAINABILITY**ALL TRINITY FURNITURE PRODUCTS HAVE LEVEL 1 CERTIFICATION**

THE BUSINESS INSTITUTIONAL FURNITURE MANUFACTURERS ASSOCIATES (BIFMA) LEVEL STANDARD IS TO PROVIDE MEASURABLE MARKET-BASED DEFINITIONS OF PROGRESSIVELY MORE SUSTAINABLE FURNITURE BY ESTABLISHING PERFORMANCE CRITERIA THAT ADDRESS ENVIRONMENTAL AND SOCIAL ASPECTS THROUGHOUT THE SUPPLY CHAIN.

THIS STANDARD PROVIDES A PATHWAY TOWARDS SUSTAINABILITY BY ESTABLISHING MEASURABLE CRITERIA FOR MULTIPLE LEVELS OF ACHIEVEMENT AND/OR PERFORMANCE. IT ADDRESSES PRODUCT BASED CHARACTERISTICS IN THE GENERAL AREA OF MATERIALS, USE OF ENERGY, HUMAN AND ECOSYSTEM HEALTH, AND SOCIAL RESPONSIBILITY IMPACTS.



Facelift Replay

GUEST / LOUNGE / TANDEM

Effective: March 1, 2025

T R I N I T Y

Date:

Page:

Modification:

Description:

DESCRIPTION:

- Upholstery Frames: Steel, Plywood & Hardwood
- Seat: High Density Polyurethane Foam Over Strap Webbing
- Back: High Density Polyurethane Foam Over Sinuous Wire Springs
- Upholstered Covers: Attached w/ Velcro / Removable For Maintenance
- Antimicrobial Moisture Barrier Fully Encapsulates All Foam Areas
- Double Needle Stitching Standard (Welting Optional - No Charge)
- Exposed Wood Legs: Solid Hardwood / Removable For Maintenance
- Leather Upholstery Not Available
- Lifetime Warranty

OPTIONS:

- RWAC-1 Solid Wood Arm Caps (Set Of 2)\$374
- RPAC-1 Black Polyester Arm Caps (Set Of 2).....\$484
- ASL Aluminum Square Legs (Set Of 4).....\$382
- PM1 Power/Data Module (1-Power / 1-USB 2 Port Simplex Charger)\$859
- PM2 Power Module (1-Power).....\$238
- USB-1 Dual Charging USB\$238
- Feather Down & Polyester Pillows Available (See Page 5)
- Specify Exposed Wood Finish (See Page 6)
- Tablet Arm / Cup Holder Options (See Facelift Replay Options Pages)

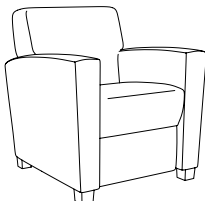
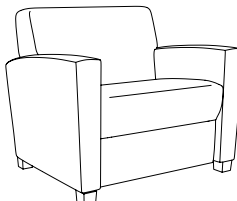
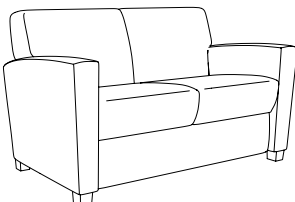
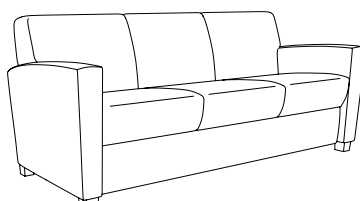
| LOUNGE | | ITEM #: | SPECIFICATIONS GRADES LIST PRICES: | | | | | | | | | | | | | |
|---|---|---|--|------------|----------|---|----------|----------|--|----------|----------|----------|----------|-----------|-----------|-----------|
|  | LOUNGE CHAIR / FULLY UPHOLSTERED | | Overall: 31.25"w 31"d 34.5"h Seat: 21"w 20"d 18"h | | | Arm: 25.5"h Weight: 80 lbs. | | | COM: 5.25 yds. COL: n/a | | | | | | | |
| | | | COM | COL | 1 | 2 | 3 | 4 | 5 | 6 | 7 | 8 | 9 | 10 | L1 | L2 |
| | 1501 | | 1542 | N/A | 1747 | 1891 | 2035 | 2180 | 2324 | 2468 | 2613 | 2757 | 2901 | 3046 | N/A | N/A |
| | | Tight Seat & Back / Removable Upholstery / 500 lb. Weight Capacity | | | | | | | | | | | | | | |
| | 1501-R | 284 | N/A | 585 | 743 | 901 | 1059 | 1217 | 1375 | 1533 | 1691 | 1849 | 2007 | N/A | N/A | |
| | | Replacement Upholstery Covers | | | | | | | | | | | | | | |
|  | BARIATRIC LOUNGE CHAIR / FULLY UPHOLSTERED | | Overall: 39.25"w 31"d 34.5"h Seat: 29"w 20"d 18"h | | | Arm: 25.5"h Weight: 95 lbs. | | | COM: 5.75 yds. COL: n/a | | | | | | | |
| | | | COM | COL | 1 | 2 | 3 | 4 | 5 | 6 | 7 | 8 | 9 | 10 | L1 | L2 |
| | 1501-X | | 1908 | N/A | 2122 | 2281 | 2439 | 2598 | 2757 | 2916 | 3074 | 3233 | 3392 | 3551 | N/A | N/A |
| | | Tight Seat & Back / Removable Upholstery / 1000 lb. Weight Capacity | | | | | | | | | | | | | | |
| | 1501-XR | 291 | N/A | 623 | 797 | 970 | 1144 | 1318 | 1492 | 1666 | 1840 | 2014 | 2187 | N/A | N/A | |
| | | Replacement Upholstery Covers | | | | | | | | | | | | | | |
|  | TWO PLACE SOFA / FULLY UPHOLSTERED | | Overall: 56.75"w 31"d 34.5"h Seat: 46.5"w 20"d 18"h | | | Arm: 25.5"h Weight: 137 lbs. | | | COM: 7.25 yds. COL: n/a | | | | | | | |
| | | | COM | COL | 1 | 2 | 3 | 4 | 5 | 6 | 7 | 8 | 9 | 10 | L1 | L2 |
| | 1502 | | 2479 | N/A | 2748 | 2950 | 3152 | 3354 | 3556 | 3758 | 3960 | 4162 | 4364 | 4566 | N/A | N/A |
| | | Tight Seat & Back / Removable Upholstery / 1000 lb. Weight Capacity | | | | | | | | | | | | | | |
| | 1502-R | 416 | N/A | 836 | 1057 | 1279 | 1500 | 1721 | 1942 | 2164 | 2385 | 2606 | 2828 | N/A | N/A | |
| | | Replacement Upholstery Covers | | | | | | | | | | | | | | |
|  | THREE PLACE SOFA / FULLY UPHOLSTERED | | Overall: 80.25"w 31"d 34.5"h Seat: 70"w 20"d 18"h | | | Arm: 25.5"h Weight: 185 lbs. | | | COM: 9.25 yds. COL: n/a | | | | | | | |
| | | | COM | COL | 1 | 2 | 3 | 4 | 5 | 6 | 7 | 8 | 9 | 10 | L1 | L2 |
| | 1503 | | 3318 | N/A | 3657 | 3917 | 4176 | 4436 | 4696 | 4956 | 5216 | 5475 | 5735 | 5995 | N/A | N/A |
| | | Tight Seat & Back / Removable Upholstery / 1000 lb. Weight Capacity | | | | | | | | | | | | | | |
| | 1503-R | 524 | N/A | 1064 | 1349 | 1634 | 1918 | 2203 | 2487 | 2772 | 3056 | 3341 | 3625 | N/A | N/A | |
| | | Replacement Upholstery Covers | | | | | | | | | | | | | | |

DESCRIPTION:

- Upholstery Frames: Steel, Plywood & Hardwood
- Seat: High Density Polyurethane Foam Over Strap Webbing
- Back: High Density Polyurethane Foam Over Sinuous Wire Springs
- Upholstered Covers: Attached w/ Velcro / Removable For Maintenance
- Antimicrobial Moisture Barrier Fully Encapsulates All Foam Areas
- Double Needle Stitching Standard (Welting Optional - No Charge)
- Exposed Wood Legs: Solid Hardwood / Removable For Maintenance
- Leather Upholstery Not Available
- Lifetime Warranty

OPTIONS:

- RWAC-1 Solid Wood Arm Caps (Set Of 2)\$374
- RPAC-1 Black Polyester Arm Caps (Set Of 2).....\$484
- ASL Aluminum Square Legs (Set Of 4).....\$382
- PM1 Power/Data Module (1-Power / 1-USB 2 Port Simplex Charger)\$859
- PM2 Power Module (1-Power).....\$238
- USB-1 Dual Charging USB\$238
- Feather Down & Polyester Pillows Available (See Page 5)
- Specify Exposed Wood Finish (See Page 6)
- Tablet Arm / Cup Holder Options (See Facelift Replay Options Pages)

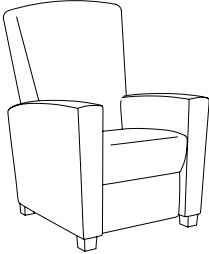
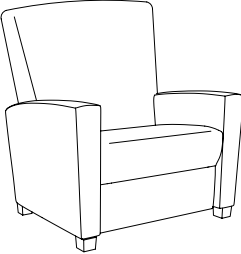
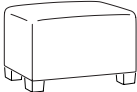
| LOUNGE | | ITEM #: | SPECIFICATIONS GRADES LIST PRICES: | | | | | | | | | | | | |
|---|---|------------|--|-------------------------|----------|--------------------|-----------------|----------|-----------------------|----------|----------|----------|-----------|-----------|-----------|
|  | HIGH BACK LOUNGE CHAIR / FULLY UPHOLSTERED | | Overall: 31.25"w 31"d 44"h | | | Arm: 25.5"h | | | COM: 5.75 yds. | | | | | | |
| | Seat: 21"w 20"d 18"h | | | Weight: 85 lbs. | | | COL: n/a | | | | | | | | |
| | | COM | COL | 1 | 2 | 3 | 4 | 5 | 6 | 7 | 8 | 9 | 10 | L1 | L2 |
| | 1515 | 1652 | N/A | 1879 | 2038 | 2197 | 2355 | 2514 | 2673 | 2832 | 2990 | 3149 | 3308 | N/A | N/A |
| <i>Tight Seat & Back / Removable Upholstery / 500 lb. Weight Capacity</i> | | | | | | | | | | | | | | | |
| | 1515-R | 301 | N/A | 633 | 807 | 980 | 1154 | 1328 | 1502 | 1676 | 1850 | 2024 | 2198 | N/A | N/A |
| <i>Replacement Upholstery Covers</i> | | | | | | | | | | | | | | | |
|  | HIGH BACK BARIATRIC LOUNGE CHAIR / FULLY UPHOLSTERED | | Overall: 39.25"w 31"d 44"h | | | Arm: 25.5"h | | | COM: 6 yds. | | | | | | |
| | Seat: 29"w 20"d 18"h | | | Weight: 100 lbs. | | | COL: n/a | | | | | | | | |
| | | COM | COL | 1 | 2 | 3 | 4 | 5 | 6 | 7 | 8 | 9 | 10 | L1 | L2 |
| | 1515-X | 2043 | N/A | 2249 | 2407 | 2566 | 2725 | 2884 | 3042 | 3201 | 3360 | 3519 | 3677 | N/A | N/A |
| <i>Tight Seat & Back / Removable Upholstery / 1000 lb. Weight Capacity</i> | | | | | | | | | | | | | | | |
| | 1515-XR | 308 | N/A | 639 | 813 | 987 | 1161 | 1334 | 1508 | 1682 | 1856 | 2030 | 2204 | N/A | N/A |
| <i>Replacement Upholstery Covers</i> | | | | | | | | | | | | | | | |
|  | OTTOMAN | | Overall: 22"w 18"d 15"h | | | Arm: n/a | | | COM: 2 yds. | | | | | | |
| | Seat: 15"h | | | Weight: 18 lbs. | | | COL: n/a | | | | | | | | |
| | | COM | COL | 1 | 2 | 3 | 4 | 5 | 6 | 7 | 8 | 9 | 10 | L1 | L2 |
| | 1516 | 530 | N/A | 602 | 653 | 703 | 754 | 804 | 855 | 905 | 956 | 1006 | 1057 | N/A | N/A |
| <i>Tight Seat & Back / Removable Upholstery / 500 lb. Weight Capacity</i> | | | | | | | | | | | | | | | |
| | 1516-R | 121 | N/A | 225 | 280 | 336 | 391 | 446 | 502 | 557 | 612 | 668 | 723 | N/A | N/A |
| <i>Replacement Upholstery Covers</i> | | | | | | | | | | | | | | | |



DESCRIPTION:

- Exposed Wood Frames: Solid Maple (Steambent Wallsaver Back Legs)
- Glued, Screwed, & Doweled Construction
- Mortise & Tenon Construction (Stacking Chairs)
- Seat: High Density Polyurethane Foam Over Sheet Webbing
- Back: High Density Polyurethane Foam Over Plywood
- Upholstered Covers: Attached w/ Velcro / Removable For Maintenance (Except 1520/1521)
- Antimicrobial Moisture Barrier Fully Encapsulates All Foam Areas (Except 1520/1521)
- Adjustable Height Leveling Glides Standard
- Lifetime Warranty

OPTIONS:

- RPAC-3 Black Polyester Arm Caps (Set Of 2).....\$173
- ST-1 Wooden Horizontal Stretchers (Guest Chairs Only).....\$97
- BR-1 Wooden Horizontal Book Rack (Guest Chairs Only).....\$218
- MGP Metal Ganging Plates (Side Chairs).....\$97 Per Seat
- Stapled On Covers.....n/c

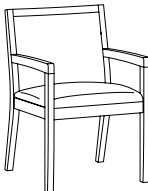
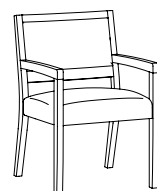
Specify Exposed Wood Finish (See Page 6)

| GUEST | ITEM #: | SPECIFICATIONS GRADES LIST PRICES: | | | | | | | | | | | | | |
|---|---------------|--|------------|----------|------------------------|----------|----------|--|----------|----------|----------|----------|-----------|-----------|-----------|
|  | | Overall: 22"w 24"d 33"h | | | Arm: 25"h | | | COM: 1.75 yds. (1520) / 1.5 yds. (1521) | | | | | | | |
| | | Seat: 19.5"w 17.5"d 18.5"h | | | Weight: 28 lbs. | | | COL: n/a | | | | | | | |
| | | COM | COL | 1 | 2 | 3 | 4 | 5 | 6 | 7 | 8 | 9 | 10 | L1 | L2 |
| | 1520 | 1050 | N/A | 1080 | 1123 | 1166 | 1209 | 1253 | 1296 | 1339 | 1383 | 1426 | 1469 | N/A | N/A |
| | | <i>Wallsaver / Fully Upholstered Outside Back / Plain Seat / 350 lb. Weight Capacity</i> | | | | | | | | | | | | | |
| | 1521 | 1078 | N/A | 1092 | 1128 | 1164 | 1200 | 1236 | 1272 | 1308 | 1344 | 1380 | 1416 | N/A | N/A |
| | | <i>Wallsaver / Exposed Wood Outside Back / Plain Seat / 350 lb. Weight Capacity</i> | | | | | | | | | | | | | |
| | | Removable Covers / Antimicrobial Moisture Barrier Not Available On 1520/1521 | | | | | | | | | | | | | |
|  | | Overall: 22"w 24"d 33"h | | | Arm: 25"h | | | COM: 2 yds. (1522) / 1.5 yds. (1523) | | | | | | | |
| | | Seat: 19.5"w 19"d 18.5"h | | | Weight: 28 lbs. | | | COL: n/a | | | | | | | |
| | | COM | COL | 1 | 2 | 3 | 4 | 5 | 6 | 7 | 8 | 9 | 10 | L1 | L2 |
| | 1522 | 1014 | N/A | 1059 | 1110 | 1160 | 1211 | 1261 | 1312 | 1362 | 1413 | 1463 | 1514 | N/A | N/A |
| | | <i>Wallsaver / Upholstered Outside Back / Plain Seat / Removable Upholstery / 350 lb. Weight Capacity</i> | | | | | | | | | | | | | |
| | 1522-R | 94 | N/A | 188 | 238 | 287 | 337 | 386 | 436 | 485 | 534 | 584 | 633 | N/A | N/A |
| | | <i>Replacement Upholstery Covers</i> | | | | | | | | | | | | | |
| | 1523 | 1030 | N/A | 1046 | 1082 | 1118 | 1154 | 1190 | 1226 | 1262 | 1299 | 1335 | 1371 | N/A | N/A |
| | | <i>Wallsaver / Exposed Wood Outside Back / Plain Seat / Removable Upholstery / 350 lb. Weight Capacity</i> | | | | | | | | | | | | | |
| | 1523-R | 91 | N/A | 168 | 209 | 251 | 292 | 333 | 374 | 415 | 457 | 498 | 539 | N/A | N/A |
| | | <i>Replacement Upholstery Covers</i> | | | | | | | | | | | | | |
|  | | Overall: 20"w 24"d 33"h | | | Arm: n/a | | | COM: 2 yds. (1524) / 1.5 yds. (1525) | | | | | | | |
| | | Seat: 20"w 19"d 18.5"h | | | Weight: 25 lbs. | | | COL: n/a | | | | | | | |
| | | COM | COL | 1 | 2 | 3 | 4 | 5 | 6 | 7 | 8 | 9 | 10 | L1 | L2 |
| | 1524 | 946 | N/A | 996 | 1046 | 1097 | 1147 | 1198 | 1248 | 1299 | 1349 | 1400 | 1450 | N/A | N/A |
| | | <i>Wallsaver / Upholstered Outside Back / Plain Seat / Removable Upholstery / 350 lb. Weight Capacity</i> | | | | | | | | | | | | | |
| | 1524-R | 94 | N/A | 188 | 238 | 287 | 337 | 386 | 436 | 485 | 534 | 584 | 633 | N/A | N/A |
| | | <i>Replacement Upholstery Covers</i> | | | | | | | | | | | | | |
| | 1525 | 957 | N/A | 977 | 1013 | 1049 | 1085 | 1121 | 1157 | 1193 | 1229 | 1265 | 1301 | N/A | N/A |
| | | <i>Wallsaver / Exposed Wood Outside Back / Plain Seat / Removable Upholstery / 350 lb. Weight Capacity</i> | | | | | | | | | | | | | |
| | 1525-R | 91 | N/A | 168 | 209 | 251 | 292 | 333 | 374 | 415 | 457 | 498 | 539 | N/A | N/A |
| | | <i>Replacement Upholstery Covers</i> | | | | | | | | | | | | | |
|  | | Overall: 20"w 24"d 39"h | | | Arm: n/a | | | COM: 2 yds. | | | | | | | |
| | | Seat: 20"w 19"d 24"h | | | Weight: 28 lbs. | | | COL: n/a | | | | | | | |
| | | COM | COL | 1 | 2 | 3 | 4 | 5 | 6 | 7 | 8 | 9 | 10 | L1 | L2 |
| | 1524-C | 977 | N/A | 1025 | 1075 | 1126 | 1176 | 1227 | 1277 | 1328 | 1378 | 1429 | 1479 | N/A | N/A |
| | | <i>Wallsaver / Upholstered Outside Back / Plain Seat / Removable Upholstery / 350 lb. Weight Capacity</i> | | | | | | | | | | | | | |
| | 1524-R | 94 | N/A | 188 | 238 | 287 | 337 | 386 | 436 | 485 | 534 | 584 | 633 | N/A | N/A |
| | | <i>Replacement Upholstery Covers</i> | | | | | | | | | | | | | |

DESCRIPTION:

- Exposed Wood Frames: Solid Maple (Steambent Wallsaver Back Legs)
- Glued, Screwed, & Doweled Construction
- Mortise & Tenon Construction (Stacking Chairs)
- Seat: High Density Polyurethane Foam Over Sheet Webbing
- Back: High Density Polyurethane Foam Over Plywood
- Upholstered Covers: Attached w/ Velcro / Removable For Maintenance
- Antimicrobial Moisture Barrier Fully Encapsulates All Foam Areas
- Adjustable Height Leveling Glides Standard
- Lifetime Warranty

OPTIONS:



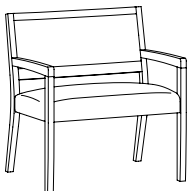
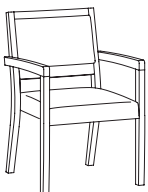

- RPAC-2 Black Polyester Arm Caps (Set Of 2).....\$173
- ST-1 Wooden Horizontal Stretchers (Guest Chairs Only).....\$97
- BR-1 Wooden Horizontal Book Rack (Guest Chairs Only).....\$218
- MGP Metal Ganging Plates (Side Chairs).....\$97 Per Seat
- SGS Soft Ganging Straps (Stacking Chairs).....\$34 Per Seat
- D800-6 Single Stacking Cart (Stacks 6 Chairs).....\$960 Each
- D800-12 Double Stacing Cart (Stacks 12 Chairs).....\$1268 Each
- Stapled On Covers n/c

Specify Exposed Wood Finish (See Page 6)

| GUEST / STACKING | | ITEM #: | SPECIFICATIONS GRADES LIST PRICES: | | | | | | | | | | | | |
|--|---|------------|--|------------------------|----------|------------------|-----------------|----------|---|----------|----------|----------|-----------|-----------|-----------|
|  | OPEN ARM BARIATRIC SIDE CHAIR / OPEN BACK | | Overall: 28"w 24"d 33"h | | | Arm: 25"h | | | COM: 2.25 yds. (1528) / 1.75 yds. (1529) | | | | | | |
| | Seat: 25.5"w 19"d 18.5"h | | | Weight: 28 lbs. | | | COL: n/a | | | | | | | | |
| | | COM | COL | 1 | 2 | 3 | 4 | 5 | 6 | 7 | 8 | 9 | 10 | L1 | L2 |
| | 1528 | 1165 | N/A | 1217 | 1274 | 1332 | 1390 | 1448 | 1505 | 1563 | 1621 | 1678 | 1736 | N/A | N/A |
| | <i>Wallsaver / Upholstered Outside Back / Plain Seat / Removable Upholstery / 500 lb. Weight Capacity</i> | | | | | | | | | | | | | | |
| 1528-R | 104 | N/A | 198 | 247 | 297 | 346 | 396 | 445 | 495 | 544 | 594 | 643 | N/A | N/A | |
| <i>Replacement Upholstery Covers</i> | | | | | | | | | | | | | | | |
| 1529 | 1209 | N/A | 1229 | 1273 | 1316 | 1359 | 1403 | 1446 | 1489 | 1532 | 1576 | 1619 | N/A | N/A | |
| <i>Wallsaver / Exposed Wood Outside Back / Plain Seat / Removable Upholstery / 500 lb. Weight Capacity</i> | | | | | | | | | | | | | | | |
| 1529-R | 101 | N/A | 178 | 219 | 260 | 301 | 343 | 384 | 425 | 466 | 508 | 549 | N/A | N/A | |
| <i>Replacement Upholstery Covers</i> | | | | | | | | | | | | | | | |
|  | OPEN ARM STACKING SIDE CHAIR / OPEN BACK | | Overall: 22"w 24"d 33"h | | | Arm: 25"h | | | COM: 2 yds. (1532) / 1.5 yds. (1533) | | | | | | |
| | Seat: 19.5"w 19"d 18.5"h | | | Weight: 28 lbs. | | | COL: n/a | | | | | | | | |
| | | COM | COL | 1 | 2 | 3 | 4 | 5 | 6 | 7 | 8 | 9 | 10 | L1 | L2 |
| | 1532 | 1032 | N/A | 1077 | 1127 | 1178 | 1228 | 1279 | 1329 | 1380 | 1430 | 1481 | 1531 | N/A | N/A |
| | <i>Wallsaver / Upholstered Outside Back / Plain Seat / Removable Upholstery / 350 lb. Weight Capacity</i> | | | | | | | | | | | | | | |
| 1532-R | 94 | N/A | 188 | 238 | 287 | 337 | 386 | 436 | 485 | 534 | 584 | 633 | N/A | N/A | |
| <i>Replacement Upholstery Covers</i> | | | | | | | | | | | | | | | |
| 1533 | 1079 | N/A | 1092 | 1128 | 1164 | 1200 | 1236 | 1273 | 1309 | 1345 | 1381 | 1417 | N/A | N/A | |
| <i>Wallsaver / Exposed Wood Outside Back / Plain Seat / Removable Upholstery / 350 lb. Weight Capacity</i> | | | | | | | | | | | | | | | |
| 1533-R | 91 | N/A | 168 | 209 | 251 | 292 | 333 | 374 | 415 | 457 | 498 | 539 | N/A | N/A | |
| <i>Replacement Upholstery Covers</i> | | | | | | | | | | | | | | | |

| ARM CAPS / TABLETS | OPTION #: SPECIFICATIONS LIST PRICES AVAILABILITY: |
|--|--|
| <p>WOOD / POLYESTER ARM CAPS</p>  <p>RWAC-1 Solid Wood Arm Cap</p>  <p>RPAC-1 Polyester Arm Cap</p> | <p>Overall: 3.625"w 30.25"d .5"h</p> <hr/> <p>RWAC-1 \$374 (Set Of 2) <i>Solid Wood Arm Cap (Specify Finish)</i></p> <p>RPAC-1 \$484 (Set Of 2) <i>Black Polyester Arm Cap (Additional Colors Available)</i></p> <p>Available: Facelift Replay Lounge (1501-1515)</p> <p>RPAC-3 \$173 (Set Of 2) <i>Black Polyester Arm Cap (Additional Colors Available)</i></p> <p>Available: Facelift Replay Guest / Stacking</p>  <p>RPAC-3 Polyester Arm Cap</p> |
| <p>TABLET ARMS / CUP HOLDER</p>  <p>Laminate Tablet Arm Shown w/ Cup Holder</p>  <p>Veneer Tablet Arm Shown w/ Cup Holder</p>  <p>Solid Surface Tablet Arm Shown w/ Cup Holder</p> | <p>Overall: 14" Diameter .75"h</p> <hr/> <p>TA-L \$509 <i>Tablet Arm With 360° Rotation - High Pressure Laminate. (Specify Laminate / Specify Left Or Right Facing Arm Location)</i></p> <p>TA-V \$580 <i>Tablet Arm With 360° Rotation - Sunburst Cherry Veneer. (Specify Finish / Specify Left Or Right Facing Arm Location)</i></p> <p>TA-C \$698 <i>Tablet Arm With 360° Rotation - White Solid Surface. (Available In White Only / Specify Left Or Right Facing Arm Location)</i></p> <p>CH-1 \$129 <i>Black Plastic Cup Holder (Only Available If Used With Tablet Arm)</i></p> <p>CH-2 \$186 <i>Spun Aluminum Cup Holder (Only Available If Used With Tablet Arm)</i></p> <p>Available: Facelift Replay Lounge</p> |
| <p>FOLD DOWN TABLET ARM</p>   | <p>Overall: 14" Diameter .75"h</p> <hr/> <p>FDTA-L \$1065 <i>Tablet Arm With 360° Rotation - High Pressure Laminate. (Specify Laminate / Specify Left Or Right Facing Arm Location)</i></p> <p>FDTA-V \$1136 <i>Tablet Arm With 360° Rotation - Sunburst Cherry Veneer. (Specify Finish / Specify Left Or Right Facing Arm Location)</i></p> <p>FDTA-C \$1278 <i>Tablet Arm With 360° Rotation - White Solid Surface. (Available In White Only / Specify Left Or Right Facing Arm Location)</i></p> <p>Available: Facelift Replay Lounge</p> |
| <p>DOUBLE ARTICULATING / SWIVEL TABLET ARM</p>  <p>ATA-L Double Articulating / Swivel Tablet Arm</p>  <p>ATA-L w/ CH-1 Black Plastic Cup Holder</p> | <p>Overall: 14" Diameter .75"h</p> <hr/> <p>ATA-L \$983 <i>Tablet Arm With 360° Rotation - High Pressure Laminate. (Specify Laminate / Specify Left Or Right Facing Arm Location)</i></p> <p>ATA-V \$1055 <i>Tablet Arm With 360° Rotation - Sunburst Cherry Veneer. (Specify Finish / Specify Left Or Right Facing Arm Location)</i></p> <p>ATA-C \$1173 <i>Tablet Arm With 360° Rotation - White Solid Surface. (Available In White Only / Specify Left Or Right Facing Arm Location)</i></p> <p>CH-1 \$129 <i>Black Plastic Cup Holder (Only Available If Used With Tablet Arm)</i></p> <p>CH-2 \$186 <i>Spun Aluminum Cup Holder (Only Available If Used With Tablet Arm)</i></p> <p>Available: Facelift Replay Lounge</p> |

| LEGS / POWER / GANGING | OPTION #: | SPECIFICATIONS LIST PRICES AVAILABILITY: |
|---|--|--|
| <p>ALUMINUM LEGS</p>  | <p>ASL</p> <p><i>Overall: 2.25"w 2.25"d 2.25"h</i></p> <p>\$382 (Set Of 4) <i>(Brushed Finish)</i></p> <p><i>Available: Facelift Replay Lounge</i></p> | |
| <p>POWER / DATA MODULE</p>  <p>PM1 Power / Data Module</p>  <p>PM2 Power Module</p>  <p>USB-1 Dual Charging USB</p> | <p>PM1</p> <p><i>PM1 Overall: 5.25"w 1.25"d 4.25"h</i> <i>PM2 Overall: 2"w 2"d .125"h</i> <i>USB-1 Overall: 2"w 2"d .125"h</i></p> <p>\$859 Power/Data Module (1-Power / 1-USB 2 Port Simplex Charger Standard) <i>Vertical / Horizontal Mount Power Module. Price Varies By Socket. Contact Customer Service For Quote. (Additional Colors Available)</i></p> <p>PM2</p> <p>\$238 Power Module (1-Power) <i>Spill-Proof Technology / Multiple Finish Options / Storm Color Standard (Specify Left or Right Facing)</i></p> <p>USB-1</p> <p>\$238 Dual Charging USB (2 Port Simplex Charger Standard) <i>Spill-Proof Technology / 2 Amps Per Port / Multiple Finish Options / Storm Color Standard (Specify Left or Right Facing)</i></p> <p><i>Available: Facelift Replay Lounge</i></p> | |
| <p>METAL GANGING PLATES</p>  <p>Replay Side Chairs Ganged With Metal Ganging Plates</p>   <p>Female & Male Ganging Connectors</p> | <p>MGP</p> <p><i>Overall: 1.5"w .5"d</i></p> <p>\$97 Per Seat <i>(Black Finish)</i></p> <p><i>Available: Facelift Replay Side Chairs</i></p> | |
| <p>SOFT GANGING STRAPS</p>  <p>Replay Stacking Chairs Soft Ganged</p> | <p>SGS</p> <p><i>Overall: 4"w 2"d</i></p> <p>\$34 Per Seat <i>Black Velcro Soft Ganging Straps</i></p> <p><i>Available: Facelift Replay Stacking Chairs</i></p> | |

| STRETCHERS / BOOK RACK / STACKING / COVERS | OPTION #: | SPECIFICATIONS LIST PRICES AVAILABILITY: |
|---|--|--|
| <p>STRETCHERS / CARTS / COVERS</p>  | <p>ST-1</p> <p><i>Overall: 23"w 25"d 1"h</i></p> <p>\$97 <i>Wooden Horizontal Stretchers</i></p> <p><i>Available: Facelift Replay Guest Chairs</i></p> | |
| <p>BOOK RACK</p>  | <p>BR-1</p> <p><i>Overall: 23"w 25"d 1"h</i></p> <p>\$218 <i>Wooden Horizontal Book Rack</i></p> <p><i>Available: Facelift Replay Guest Chairs</i></p> | |
| <p>STACKING CARTS</p>  <p>Single Stacking</p> <p>Double Stacking</p> | <p><i>Overall: 26"w 37"d 12"h (Single Stacking Cart) / 37"w 50"d 12"h (Double Stacking Cart)</i></p> <p>D800-6 \$960 <i>Single Stacking Cart (Stacks 6 Chairs)</i></p> <p>D800-12 \$1268 <i>Double Stacking Cart (Stacks 12 Chairs)</i></p> <p><i>Available: Replay Stacking Chairs</i></p> | |
| <p>CONTRASTING COVERS</p>  | <p><i>Overall: N/A</i></p> <p>CC \$129</p> <p><i>NOTE: If Two Or More Upholsteries Or Leathers Are Used On Any Piece Of Furniture, Then A Contrast Charge Will Apply Per Order. When Using Trinity Upholstery, The Higher Priced Upholstery Grade Will Be Used In Pricing, Unless It's Trinity Leather With Fabric Contrast Welt, Or COM With Trinity Contrast Welt, Then Contact Customer Service For Pricing.</i></p> <p><i>Available: Facelift Replay Collection</i></p> | |

Facelift Replay

HEALTHCARE MOTION

Effective: March 1, 2025

T R I N I T Y

Date:

Page:

Modification:

Description:

DESCRIPTION:

- Upholstery Frames: Steel, Plywood & Hardwood
- Seat: High Density Polyurethane Foam Over Sheet Webbing
- Back: High Density Polyurethane Foam Over Polypropylene Webbing
- Upholstered Covers: Attached w/ Velcro / Removable For Maintenance
- Removable Bolster Pillow For 1504 / 1505 (5" Diameter)
- Antimicrobial Moisture Barrier Fully Encapsulates All Foam Areas
- Double Needle Stitching Standard (Welting Optional - No Charge)
- Metal To Metal Connections For All Hardware Assembly
- Leather Upholstery Not Available
- Lifetime Warranty

OPTIONS:

- RWAC-3 Solid Wood Arm Caps (Set Of 2)\$411
- RPAC-2 Polyester Arm Caps (Set Of 2)\$518
- LC Locking Casters (Set Of 2)\$44
- NLC Non-Locking Casters (Set Of 2).....\$37
- 3LC 3" Locking Casters - #1506 Model Only (Set Of 2).....\$218
- PM1 Power/Data Module (1-Power / 1-USB 2 Port Simplex Charger)\$859
- Tablet Arm / Cup Holder Options (See Facelift Replay Healthcare Options Pages)
- Feather Down & Polyester Pillows Available (See Page 5)
- Specify Exposed Wood Finish (See Page 6)

SLEEPOVER UNITS

ITEM #: SPECIFICATIONS | GRADES | LIST PRICES:

LOUNGE CHAIR / FULLY UPHOLSTERED

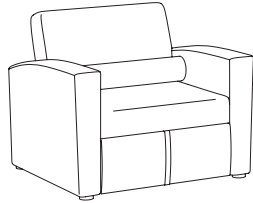

Healthcare Motion

| | | | | | | | | | | | | | |
|---|------------|------------------------------------|----------|-------------------------------|----------|-------------------------|----------|----------------------|----------|----------|-----------|-----------|-----------|
| | | Overall: 37.5"w 34.5"d 33"h | | Overall Length: 84"d | | Arm: 24"h | | COM: 6.5 yds. | | | | | |
| | | Sleep Area: 28"w 80"d | | Seat: 28"w 23"d 17.5"h | | Weight: 175 lbs. | | COL: n/a | | | | | |
| COM | COL | 1 | 2 | 3 | 4 | 5 | 6 | 7 | 8 | 9 | 10 | L1 | L2 |
| 1504 | N/A | 4860 | 5040 | 5221 | 5401 | 5582 | 5762 | 5942 | 6123 | 6303 | 6484 | N/A | N/A |
| <i>Tight Seat & Back / Removable Upholstery / 500 lb. Weight Capacity</i> | | | | | | | | | | | | | |
| 1504-R | N/A | 719 | 916 | 1114 | 1311 | 1509 | 1706 | 1904 | 2102 | 2299 | 2497 | N/A | N/A |
| <i>Replacement Upholstery Covers</i> | | | | | | | | | | | | | |

TWO PLACE SOFA / FULLY UPHOLSTERED

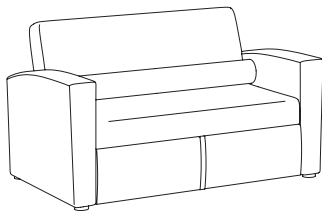

Healthcare Motion

| | | | | | | | | | | | | | |
|---|------------|------------------------------------|----------|-------------------------------|----------|-------------------------|----------|--------------------|----------|----------|-----------|-----------|-----------|
| | | Overall: 57.5"w 34.5"d 33"h | | Overall Length: 84"d | | Arm: 24"h | | COM: 9 yds. | | | | | |
| | | Sleep Area: 48"w 80"d | | Seat: 48"w 23"d 17.5"h | | Weight: 225 lbs. | | COL: n/a | | | | | |
| COM | COL | 1 | 2 | 3 | 4 | 5 | 6 | 7 | 8 | 9 | 10 | L1 | L2 |
| 1505 | N/A | 6067 | 6320 | 6572 | 6825 | 7077 | 7330 | 7583 | 7835 | 8088 | 8340 | N/A | N/A |
| <i>Tight Seat & Back / Removable Upholstery / 750 lb. Weight Capacity</i> | | | | | | | | | | | | | |
| 1505-R | N/A | 949 | 1225 | 1502 | 1779 | 2055 | 2332 | 1660 | 1818 | 1976 | 2134 | N/A | N/A |
| <i>Replacement Upholstery Covers</i> | | | | | | | | | | | | | |

FOUR POSITION ADJUSTMENT FOR 1504 / 1505

See Revival Healthcare Motion And Evolve Healthcare Motion For Additional Sleeper Units.



1) Closed Position



2) Ottoman Position



3) Chaise Position



4) Full-Recline Position
Overall Length - 84"d

BACK-FLIP SLEEPER SOFA

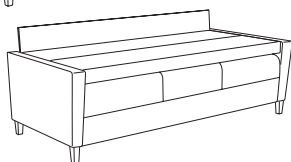
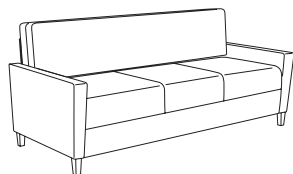





| | | | | | | | | | | | | | |
|---|------------|-----------------------------------|----------|-------------------------|----------|---------------------|----------|----------|----------|----------|-----------|-----------|-----------|
| | | Overall: 79"w 36"d 36"h | | Arm: 24.5"h | | COM: 13 yds. | | | | | | | |
| | | Sleep Area: 70"w 31"d 20"h | | Weight: 235 lbs. | | COL: n/a | | | | | | | |
| COM | COL | 1 | 2 | 3 | 4 | 5 | 6 | 7 | 8 | 9 | 10 | L1 | L2 |
| 1506 | N/A | 4723 | 5091 | 5459 | 5827 | 6195 | 6564 | 6932 | 7300 | 7668 | 8036 | N/A | N/A |
| <i>Tight Seat & Back / Removable Upholstery / 1000 lbs. Weight Capacity</i> | | | | | | | | | | | | | |
| 1506-R | N/A | 1914 | 2309 | 2704 | 3099 | 3494 | 3889 | 4285 | 4680 | 5075 | 5470 | N/A | N/A |
| <i>Replacement Upholstery Covers</i> | | | | | | | | | | | | | |

DESCRIPTION:

- Upholstery Frames: Steel, Plywood & Hardwood
- Seat: High Density Polyurethane Foam Over Sheet Webbing
- Back: High Density Polyurethane Foam Over Sinuous Wire Springs
- Upholstered Covers: Attached w/ Velcro / Removable For Maintenance
- Antimicrobial Moisture Barrier Fully Encapsulates All Foam Areas
- Central Braking w/ Lock & unlocks pedals
- Double Needle Stitching Standard (Welting Optional - No Charge)
- Dual-Wheel Casters: (2) Front Locking/Swivel & (2) Rear Non-Locking/Non-Swivel
- Leather Upholstery Not Available
- Lifetime Warranty

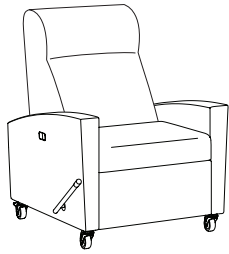
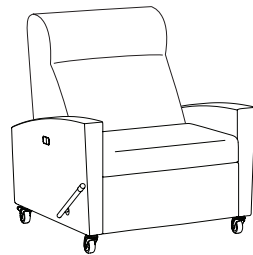
OPTIONS:

Layflat Medical Recliner Options (See Facelift Replay Healthcare Options Pages)
 Feather Down & Polyester Pillows Available (See Page 5)

| INFUSION RECLINERS | | ITEM #: | SPECIFICATIONS GRADES LIST PRICES: | | | | | | | | | | | | | | |
|---|--|--|--|------------|----------|---|----------|----------|---|----------|----------|----------|----------|-----------|-----------|-----------|-----|
|  | | INFUSION LAYFLAT MEDICAL RECLINER | Overall: 32.75"w 38.5"d 45"h Seat: 24"w 20"d 20"h | | | Arm: 28"h Weight: 160 lbs. | | | COM: 5.5 yds. COL: n/a | | | | | | | | |
| | | | COM | COL | 1 | 2 | 3 | 4 | 5 | 6 | 7 | 8 | 9 | 10 | L1 | L2 | |
| | | | 1507-L | 3776 | N/A | 3853 | 3995 | 4136 | 4277 | 4419 | 4560 | 4702 | 4843 | 4984 | 5126 | N/A | N/A |
| | | | <i>Infusion Layflat / Tight Seat & Back / Removable Upholstery / 500 lb. Weight Capacity</i> | | | | | | | | | | | | | | |
|  | | BARIATRIC INFUSION LAYFLAT MEDICAL RECLINER | Overall: 37.75"w 38.5"d 45"h Seat: 29"w 20"d 20"h | | | Arm: 28"h Weight: 185 lbs. | | | COM: 6 yds. COL: n/a | | | | | | | | |
| | | | COM | COL | 1 | 2 | 3 | 4 | 5 | 6 | 7 | 8 | 9 | 10 | L1 | L2 | |
| | | | 1507-XL | 3866 | N/A | 3962 | 4115 | 4268 | 4421 | 4574 | 4728 | 4881 | 5034 | 5187 | 5340 | N/A | N/A |
|  | | | 1507-T | 3856 | N/A | 3929 | 4070 | 4211 | 4353 | 4494 | 4636 | 4777 | 4918 | 5060 | 5201 | N/A | N/A |
| | | | <i>Infusion Trendelenburg / Tight Seat & Back / Removable Upholstery / 500 lb. Weight Capacity</i> | | | | | | | | | | | | | | |
|  | | | 1507-R | 376 | N/A | 721 | 903 | 1086 | 1268 | 1451 | 1633 | 1816 | 1999 | 2181 | 2364 | N/A | N/A |
| | | | <i>Replacement Upholstery Covers</i> | | | | | | | | | | | | | | |
|  | | | 1507-XL | 3866 | N/A | 3962 | 4115 | 4268 | 4421 | 4574 | 4728 | 4881 | 5034 | 5187 | 5340 | N/A | N/A |
| | | | <i>Infusion Layflat / Tight Seat & Back / Removable Upholstery / 600 lb. Weight Capacity</i> | | | | | | | | | | | | | | |
| | | | 1507-XT | 3991 | N/A | 4079 | 4233 | 4386 | 4539 | 4692 | 4845 | 4999 | 5152 | 5305 | 5458 | N/A | N/A |
|  | | | 1507-XR | 383 | N/A | 762 | 962 | 1162 | 1362 | 1562 | 1762 | 1962 | 2162 | 2362 | 2562 | N/A | N/A |
| | | | <i>Replacement Upholstery Covers</i> | | | | | | | | | | | | | | |

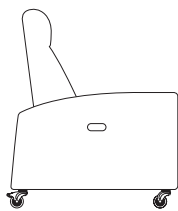

Upright Position
38.5"D

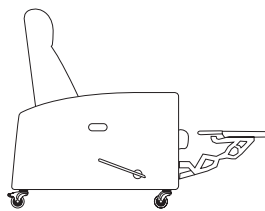

Extended Footrest Position
57.5"D

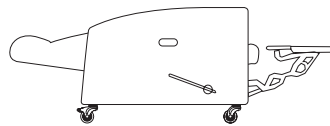

Layflat Position
73.75"D7

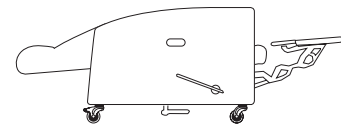

Trendelenburg Position
4.75"D

 See Revival Healthcare Motion And Evolve Healthcare Motion For Additional Infusion Layflat Medical Recliners.

DESCRIPTION:

- Upholstery Frames: Steel, Plywood & Hardwood
- Seat: High Density Polyurethane Foam Over Sheet Webbing
- Back: High Density Polyurethane Foam Over Polypropylene Webbing
- Upholstered Covers: Attached w/ Velcro / Removable For Maintenance
- Antimicrobial Moisture Barrier Fully Encapsulates All Foam Areas
- Double Needle Stitching Standard (Wetling Optional - No Charge)
- Exposed Wood Legs: Solid Hardwood / Removable For Maintenance
- Leather Upholstery Not Available
- Lifetime Warranty

OPTIONS:

- RWAC-1 Solid Wood Arm Caps (Set Of 2)\$374
 - RPAC-1 Polyester Arm Caps (Set Of 2)\$484
 - ASL Aluminum Square Legs (Set Of 4).....\$382
 - LC Locking Casters For 1809 Ottoman (Set Of 2)\$44
 - WR Wood Ring Base - Replaces Metal Base On 1510-G/1510-SG\$224
 - PM1 Power/Data Module (1-Power / 1-USB 2 Port Simplex Charger)\$859
- Feather Down & Polyester Pillows Available (See Page 5)
Specify Exposed Wood Finish (See Page 6)
Tablet Arm / Cup Holder Options (See Facelift Replay Healthcare Options Pages)

PATIENT CHAIR / GLIDER

ITEM #:

SPECIFICATIONS | GRADES | LIST PRICES:

ASYNCHRONOUS PATIENT CHAIR / FULLY UPHOLSTERED

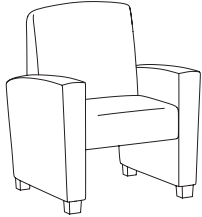

Healthcare Motion

| | | Overall: 32.5"w 35.5"d 38"h (1508) / 37.5"w 35.5"d 38"h (1508-X) | | | | | | | | | | Arm: 24"h | | COM: 4.5 yds. | |
|--|-----|---|------|------|------|------|------|------|------|------|------|------------------------|-----|----------------------|--|
| | | Seat: 21"w 20"d 18"h (1508) / 26"w 20"d 18"h (1508-X) | | | | | | | | | | Weight: 70 lbs. | | COL: n/a | |
| COM | COL | 1 | 2 | 3 | 4 | 5 | 6 | 7 | 8 | 9 | 10 | L1 | L2 | | |
| 1508 | N/A | 1865 | 2016 | 2166 | 2316 | 2467 | 2617 | 2767 | 2918 | 3068 | 3218 | N/A | N/A | | |
| <i>Tight Seat & Back / Removable Upholstery / 500 lb. Weight Capacity</i> | | | | | | | | | | | | | | | |
| 1508-R | N/A | 509 | 643 | 778 | 912 | 1046 | 1181 | 1315 | 1449 | 1584 | 1718 | N/A | N/A | | |
| <i>Replacement Upholstery Covers</i> | | | | | | | | | | | | | | | |
| 1508-X | N/A | 1965 | 2132 | 2299 | 2467 | 2634 | 2801 | 2968 | 3135 | 3302 | 3469 | N/A | N/A | | |
| <i>Tight Seat & Back / Removable Upholstery / 500 lbs. Weight Capacity</i> | | | | | | | | | | | | | | | |
| 1508-XR | N/A | 509 | 643 | 778 | 912 | 1046 | 1181 | 1315 | 1449 | 1584 | N/A | N/A | | | |
| <i>Replacement Upholstery Covers</i> | | | | | | | | | | | | | | | |

OTTOMAN ON CASTERS / STOWS UNDER ALL PATIENT CHAIRS

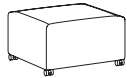

Healthcare Motion

| | | Overall: 18"w 18"d 11"h | | | | | Arm: n/a | | | | | COM: 1 yd. | | | |
|---|-----|--------------------------------|-----|-----|-----|-----|------------------------|-----|-----|-----|-----|-------------------|-----|-----|-----|
| | | Seat: n/a | | | | | Weight: 25 lbs. | | | | | COL: n/a | | | |
| COM | COL | 1 | 2 | 3 | 4 | 5 | 6 | 7 | 8 | 9 | 10 | L1 | L2 | | |
| 1809 | | 386 | 425 | 409 | 430 | 452 | 474 | 495 | 517 | 539 | 560 | 582 | 603 | N/A | N/A |
| <i>Removable Upholstery / 350 lb. Weight Capacity</i> | | | | | | | | | | | | | | | |
| 1809-R | | 94 | 103 | 136 | 160 | 183 | 207 | 231 | 254 | 278 | 302 | 326 | 349 | N/A | N/A |
| <i>Replacement Upholstery Covers</i> | | | | | | | | | | | | | | | |

LOUNGE GLIDER / FULLY UPHOLSTERED

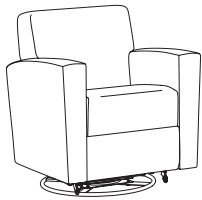

Healthcare Motion

| | | Overall: 32"w 32"d 35"h | | | | | Arm: 24"h | | | | | COM: 5.25 yds. | |
|--|-----|--------------------------------|------|------|------|------|-------------------------|------|------|------|------|-----------------------|-----|
| | | Seat: 21"w 20"d 18"h | | | | | Weight: 115 lbs. | | | | | COL: n/a | |
| COM | COL | 1 | 2 | 3 | 4 | 5 | 6 | 7 | 8 | 9 | 10 | L1 | L2 |
| 1510-G | N/A | 2013 | 2157 | 2301 | 2446 | 2590 | 2734 | 2878 | 3023 | 3167 | 3311 | N/A | N/A |
| <i>Circular Metal Base / Tight Seat & Back / Removable Upholstery / 500 lb. Weight Capacity</i> | | | | | | | | | | | | | |
| 1510-SG | N/A | 2151 | 2295 | 2440 | 2584 | 2728 | 2873 | 3017 | 3161 | 3306 | 3450 | N/A | N/A |
| <i>Swivel Glider w/ Circular Metal Base / Tight Seat & Back / Removable Upholstery / 500 lb. Weight Capacity</i> | | | | | | | | | | | | | |
| 1510-R | N/A | 581 | 739 | 897 | 1055 | 1213 | 1371 | 1529 | 1687 | 1846 | 2004 | N/A | N/A |
| <i>Replacement Upholstery Covers</i> | | | | | | | | | | | | | |

See Revival Healthcare Motion And Evolve Healthcare Motion For Additional Patient Chairs & Gliders.

DESCRIPTION:

- Upholstery Frames: Steel, Plywood & Hardwood
- Seat: High Density Polyurethane Foam Over Sheet Webbing
- Back: High Density Polyurethane Foam Over Sinuous Wire Springs
- Upholstered Covers: Attached w/ Velcro / Removable For Maintenance
- Antimicrobial Moisture Barrier Fully Encapsulates All Foam Areas
- Double Needle Stitching Standard (Welting Optional - No Charge)
- Leather Upholstery Not Available
- Lifetime Warranty







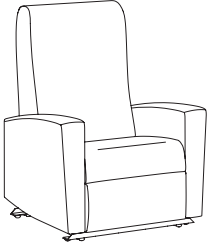

OPTIONS:

(See Facelift Replay Healthcare Options Pages)

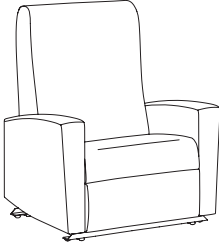
- RWAC-1 Solid Wood Arm Caps (Set Of 2)\$374
- RPAC-1 Polyester Arm Caps (Set Of 2)\$484
- ER-1 Electric Recline\$1054
- BB Battery Backup\$548
- HM Heat & Massage\$1498
- H Heat Only\$1142

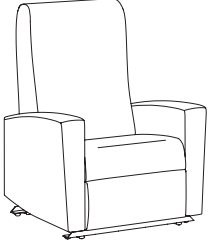
Feather Down & Polyester Pillows Available (See Page 5)

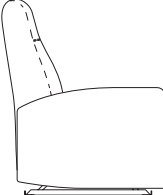
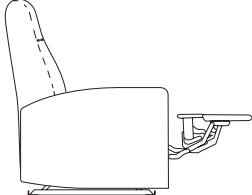
Specify Exposed Wood Finish (See Page 6)

| WALLSAVER | | ITEM #: | SPECIFICATIONS GRADES LIST PRICES: | | | | | | | | | | | | | |
|---|--|---------|---|------------|----------|--|----------|----------|---|----------|----------|----------|----------|-----------|-----------|-----------|
|  | | 1511 | Overall: 30.5"w 32"d 43"h | | | Arm: 23"h | | | COM: 5 yds. | | | | | | | |
| | | | Seat: 21"w 20.5"d 18"h | | | Weight: 110 lbs. | | | COL: n/a | | | | | | | |
| | | | COM | COL | 1 | 2 | 3 | 4 | 5 | 6 | 7 | 8 | 9 | 10 | L1 | L2 |
| | | | 2089 | N/A | 2292 | 2451 | 2610 | 2768 | 2927 | 3086 | 3245 | 3403 | 3562 | 3721 | N/A | N/A |
| | | | <i>Tight Seat & Back / Removable Upholstery / 6" Wall Proximity / 350 lb. Weight Capacity</i> | | | | | | | | | | | | | |
| | | 1511-R | 296 | N/A | 580 | 730 | 880 | 1030 | 1181 | 1331 | 1481 | 1631 | 1781 | 1931 | N/A | N/A |
| | | | <i>Replacement Upholstery Covers</i> | | | | | | | | | | | | | |
|  Healthcare Motion | | | | | | | | | | | | | | | | |
|  | | 1511-X | Overall: 35.5"w 32"d 43"h | | | Arm: 23"h | | | COM: 5.5 yds. | | | | | | | |
| | | | Seat: 26"w 20.5"d 18"h | | | Weight: 125 lbs. | | | COL: n/a | | | | | | | |
| | | | COM | COL | 1 | 2 | 3 | 4 | 5 | 6 | 7 | 8 | 9 | 10 | L1 | L2 |
| | | | 2230 | N/A | 2426 | 2585 | 2743 | 2902 | 3061 | 3219 | 3378 | 3537 | 3696 | 3854 | N/A | N/A |
| | | | <i>Tight Seat & Back / Removable Upholstery / 6" Wall Proximity / 500 lb. Weight Capacity</i> | | | | | | | | | | | | | |
| | | 1511-XR | 302 | N/A | 618 | 784 | 950 | 1116 | 1282 | 1448 | 1614 | 1780 | 1946 | 2112 | N/A | N/A |
| | | | <i>Replacement Upholstery Covers</i> | | | | | | | | | | | | | |
|  Healthcare Motion | | | | | | | | | | | | | | | | |
|  | | 1511-E | Overall: 30.5"w 32"d 43"h | | | Arm: 23"h | | | COM: 5 yds. | | | | | | | |
| | | | Seat: 21"w 20.5"d 18"h | | | Weight: 110 lbs. | | | COL: n/a | | | | | | | |
| | | | COM | COL | 1 | 2 | 3 | 4 | 5 | 6 | 7 | 8 | 9 | 10 | L1 | L2 |
| | | | 3036 | N/A | 3188 | 3346 | 3505 | 3664 | 3822 | 3981 | 4140 | 4299 | 4457 | 4616 | N/A | N/A |
| | | | <i>Tight Seat & Back / Removable Upholstery / 6" Wall Proximity / 350 lb. Weight Capacity</i> | | | | | | | | | | | | | |
| | | 1511-R | 296 | N/A | 580 | 730 | 880 | 1030 | 1181 | 1331 | 1481 | 1631 | 1781 | 1931 | N/A | N/A |
| | | | <i>Replacement Upholstery Covers</i> | | | | | | | | | | | | | |
|  Healthcare Motion | | | | | | | | | | | | | | | | |
|  See Revival Healthcare Motion And Evolve Healthcare Motion For Additional Wallsaver Recliners. | | | | | | | | | | | | | | | | |
| | | |  | | |  | | |  | | | | | | | |
| | | | Upright Position 32°D | | | Extended Footrest Position 52°D | | | Full Recline Position 64.5°D | | | | | | | |

DESCRIPTION:

- Upholstery Frames: Steel, Plywood & Hardwood
- Seat: High Density Polyurethane Foam Over Sheet Webbing
- Back: High Density Polyurethane Foam Over Sinuous Wire Springs
- Upholstered Covers: Attached w/ Velcro / Removable For Maintenance
- Antimicrobial Moisture Barrier Fully Encapsulates All Foam Areas
- Double Needle Stitching Standard (Wetling Optional - No Charge)
- Dual-Wheel Casters: (2) Front Locking/Swivel & (2) Rear Non-Locking/Non-Swivel (1514)
- (2) Drop Down Side Trays Mounted To Black Metal Tubing (1514)
- Exposed Wood Legs (1512): Solid Hardwood / Removable For Maintenance
- Leather Upholstery Not Available
- Lifetime Warranty

OPTIONS:

(See Facelift Replay Healthcare Options Pages)
 Feather Down & Polyester Pillows Available (See Page 5)

INFUSION / STAND-UP RECLINER

ITEM #:

SPECIFICATIONS | GRADES | LIST PRICES:

INFUSION WALLSAVER RECLINER / FULLY UPHOLSTERED



Optional Central Braking Available

Healthcare Motion

See Revival & Evolve Healthcare Motion For Additional Infusion Wall Saver Recliners.

Overall: 31.25"w 34"d 46"h **Arm:** 27"h **COM:** 5 yds.
Seat: 21"w 20.5"d 19"h **Weight:** 130 lbs. **COL:** n/a

| COM | COL | 1 | 2 | 3 | 4 | 5 | 6 | 7 | 8 | 9 | 10 | L1 | L2 |
|---|-----|------|------|------|------|------|------|------|------|------|------|-----|-----|
| 1514 | N/A | 3373 | 3532 | 3691 | 3851 | 4010 | 4169 | 4328 | 4487 | 4646 | 4805 | N/A | N/A |
| <i>Tight Seat & Back / Removable Upholstery / 350 lb. Weight Capacity</i> | | | | | | | | | | | | | |
| 1514-R | N/A | 669 | 851 | 1033 | 1214 | 1396 | 1578 | 1760 | 1942 | 2123 | 2305 | N/A | N/A |
| <i>Replacement Upholstery Covers</i> | | | | | | | | | | | | | |

***NOTE: ELECTRIC OPTION NOT AVAILABLE ON INFUSION RECLINERS IN COMBINATION WITH CASTERS.**



Upright Position
32"D



Extended Footrest Position
52"D



Full Recline Position
64.5"D

ELECTRIC STAND-UP RECLINER / FULLY UPHOLSTERED

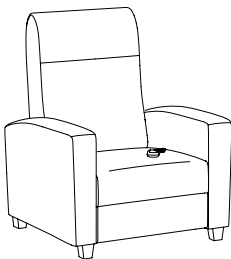

Healthcare Motion

See Revival Healthcare Motion For Additional Electric Stand-Up Recliner.

Overall: 33"w 35"d 42"h **Arm:** 24.5"h **COM:** 6.5 yds.
Seat: 21.5"w 21.75"d 18"h **Weight:** 145 lbs. **COL:** n/a

| COM | COL | 1 | 2 | 3 | 4 | 5 | 6 | 7 | 8 | 9 | 10 | L1 | L2 |
|---|-----|------|------|------|------|------|------|------|------|------|------|-----|-----|
| 1512 | N/A | 3658 | 3866 | 4075 | 4284 | 4493 | 4701 | 4910 | 5119 | 5328 | 5537 | N/A | N/A |
| <i>Tight Seat & Back / Removable Upholstery / 350 lb. Weight Capacity</i> | | | | | | | | | | | | | |
| 1512-R | N/A | 704 | 902 | 1100 | 1297 | 1495 | 1692 | 1890 | 2088 | 2285 | 2483 | N/A | N/A |
| <i>Replacement Upholstery Covers</i> | | | | | | | | | | | | | |

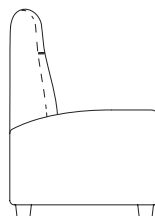

Upright Position
35"D

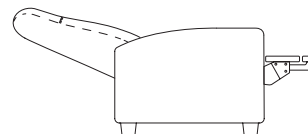

Full Recline Position
66"D

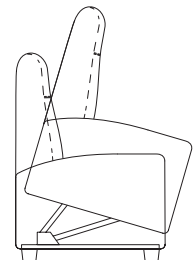

Stand-Up Position
59"H

DESCRIPTION:

- Upholstery Frames: Steel, Plywood & Hardwood
- Seat: High Density Polyurethane Foam Over Sheet Webbing
- Back: High Density Polyurethane Foam Over Sinuous Wire Springs
- Upholstered Covers: Attached w/ Velcro / Removable For Maintenance
- Antimicrobial Moisture Barrier Fully Encapsulates All Foam Areas
- Double Needle Stitching Standard (Welting Optional - No Charge)
- Rotational & Directional Locking Casters (Rear)
- Leather Upholstery Not Available
- Lifetime Warranty

OPTIONS:

Layflat Medical Recliner Options (See Facelift Replay Healthcare Options Pages)
 Feather Down & Polyester Pillows Available (See Page 5)

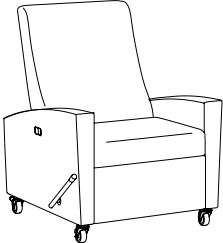
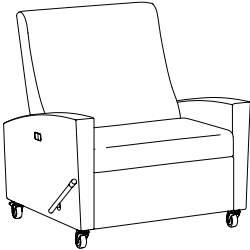
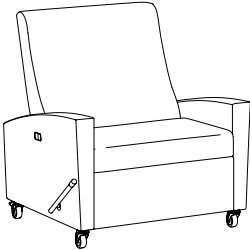
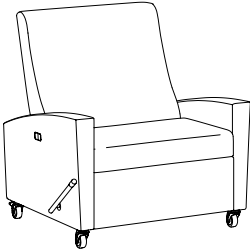
| LAYFLAT MEDICAL RECLINER | | ITEM #: | SPECIFICATIONS GRADES LIST PRICES: | | | | | | | | | | | | | | |
|---|--|---|---|------------|----------|---|----------|----------|---|----------|----------|----------|----------|-----------|-----------|-----------|-----|
|  | | LAYFLAT / TRENDELENBURG RECLINER | Overall: 32.75"w 38.5"d 45"h Seat: 24"w 20"d 20"h | | | Arm: 28"h Weight: 160 lbs. | | | COM: 5.5 yds. COL: n/a | | | | | | | | |
| | | | COM | COL | 1 | 2 | 3 | 4 | 5 | 6 | 7 | 8 | 9 | 10 | L1 | L2 | |
| | | | 1513-L | 3728 | N/A | 3875 | 4050 | 4226 | 4401 | 4577 | 4752 | 4927 | 5103 | 5278 | 5454 | N/A | N/A |
| | | | <i>Layflat / Tight Seat & Back / Removable Upholstery / 500 lb. Weight Capacity</i> | | | | | | | | | | | | | | |
|  | | BARIATRIC LAYFLAT / TRENDELENBURG RECLINER | Overall: 37.75"w 38.5"d 45"h Seat: 29"w 20"d 20"h | | | Arm: 28"h Weight: 185 lbs. | | | COM: 6 yds. COL: n/a | | | | | | | | |
| | | | COM | COL | 1 | 2 | 3 | 4 | 5 | 6 | 7 | 8 | 9 | 10 | L1 | L2 | |
| | | | 1513-XL | 3855 | N/A | 4029 | 4221 | 4413 | 4605 | 4797 | 4989 | 5181 | 5373 | 5566 | 5758 | N/A | N/A |
| | | | <i>Layflat / Tight Seat & Back / Removable Upholstery / 600 lb. Weight Capacity</i> | | | | | | | | | | | | | | |
|  | | BARIATRIC LAYFLAT / TRENDELENBURG RECLINER | Overall: 37.75"w 38.5"d 45"h Seat: 29"w 20"d 20"h | | | Arm: 28"h Weight: 185 lbs. | | | COM: 6 yds. COL: n/a | | | | | | | | |
| | | | COM | COL | 1 | 2 | 3 | 4 | 5 | 6 | 7 | 8 | 9 | 10 | L1 | L2 | |
| | | | 1513-XT | 4032 | N/A | 4196 | 4388 | 4580 | 4772 | 4964 | 5156 | 5348 | 5540 | 5733 | 5925 | N/A | N/A |
| | | | <i>Trendelenburg / Tight Seat & Back / Removable Upholstery / 600 lb. Weight Capacity</i> | | | | | | | | | | | | | | |
|  | | BARIATRIC LAYFLAT / TRENDELENBURG RECLINER | Overall: 37.75"w 38.5"d 45"h Seat: 29"w 20"d 20"h | | | Arm: 28"h Weight: 185 lbs. | | | COM: 6 yds. COL: n/a | | | | | | | | |
| | | | COM | COL | 1 | 2 | 3 | 4 | 5 | 6 | 7 | 8 | 9 | 10 | L1 | L2 | |
| | | | 1513-XR | 349 | N/A | 693 | 875 | 1057 | 1238 | 1420 | 1602 | 1784 | 1966 | 2147 | 2329 | N/A | N/A |
| | | | <i>Replacement Upholstery Covers</i> | | | | | | | | | | | | | | |

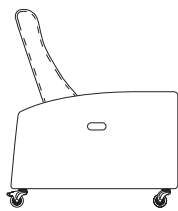

Upright Position
38.5"D

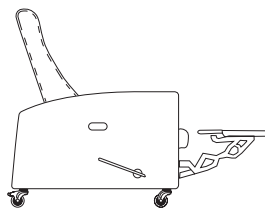

Extended Footrest Position
57.5"D

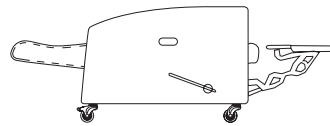

Layflat Position
73.75"D

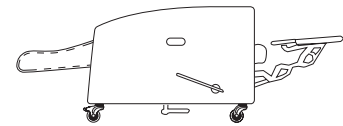







Trendelenburg Position
74.75"D

 See Revival Healthcare Motion And Evolve Healthcare Motion For Additional Layflat Medical Recliners.

| ARM CAPS / TABLETS | OPTION #: SPECIFICATIONS LIST PRICES AVAILABILITY: |
|---|--|
| <p>SOLID WOOD ARM CAPS</p>  | <p>Overall: Dimensions Will Vary By Style</p> <hr/> <p>RWAC-1 \$374 (Set Of 2) (1508 Asynchronous Patient Chair) - Specify Finish (1510-G Lounge Glider / 1510-SG Lounge Swivel Glider) - Specify Finish (1511 Wallsaver Recliner / 1511-X Bariatric Wallsaver Recliner / 1514 Infusion Wallsaver Recliner) - Specify Finish</p> <p>RWAC-2 \$411 (Set Of 2) (1512 Electric Standup Recliner) - Specify Finish</p> <p>RWAC-3 \$411 (Set Of 2) (1504 / 1505 Sleepover Lounge) - Specify Finish (1513-L & 1513-T Medical Recliners / 1513-XL & 1513-XT Bariatric Medical Recliners) - Specify Finish</p> |
| <p>POLYESTER ARM CAPS</p>  | <p>Overall: Dimensions Will Vary By Style</p> <hr/> <p>RPAC-1 \$484 (Set Of 2) POLYESTER (1508 Asynchronous Patient Chair) (1510-G Lounge Glider / 1510-SG Lounge Swivel Glider) (1511 Wallsaver Recliner / 1511-X Bariatric Wallsaver Recliner / 1514 Infusion Wallsaver Recliner)</p> <p>RPAC-2 \$518 (Set Of 2) POLYESTER (1504 / 1505 Sleepover Lounge) - Specify Finish (1507-L, 1507-T, 1507-XL, 1507-XT, 1513-L, 1513-T, 1513-XL, 1513-XT Medical Recliners) - Specify Finish</p> |
| <p>TABLET ARMS / CUP HOLDER</p>  <p>Laminate Tablet Arm Shown w/ Cup Holder</p>  <p>Veneer Tablet Arm Shown w/ Cup Holder</p>  <p>Solid Surface Tablet Arm Shown w/ Cup Holder</p> | <p>Overall: 14" Diameter .75"h</p> <hr/> <p>TA-L \$509 Tablet Arm With 360° Rotation - High Pressure Laminate. (Specify Laminate / Specify Left Or Right Facing Arm Location)</p> <p>TA-V \$580 Tablet Arm With 360° Rotation - Sunburst Cherry Veneer. (Specify Finish / Specify Left Or Right Facing Arm Location)</p> <p>TA-C \$698 Tablet Arm With 360° Rotation - White Solid Surface. (Available In White Only / Specify Left Or Right Facing Arm Location)</p> <p>CH-1 \$129 Black Plastic Cup Holder (Only Available If Used With Tablet Arm)</p> <p>CH-2 \$186 Spun Aluminum Cup Holder (Only Available If Used With Tablet Arm)</p> <p>Available: Facelift Replay Sleepover Lounge</p> |
| <p>FOLD DOWN TABLET ARM</p>   | <p>Overall: 14" Diameter .75"h</p> <hr/> <p>FDTA-L \$1065 Tablet Arm With 360° Rotation - High Pressure Laminate. (Specify Laminate / Specify Left Or Right Facing Arm Location)</p> <p>FDTA-V \$1136 Tablet Arm With 360° Rotation - Sunburst Cherry Veneer. (Specify Finish / Specify Left Or Right Facing Arm Location)</p> <p>FDTA-C \$1278 Tablet Arm With 360° Rotation - White Solid Surface. (Available In White Only / Specify Left Or Right Facing Arm Location)</p> <p>Available: Facelift Replay Sleepover Lounge</p> |

| TABLETS / CASTERS | OPTION #: | SPECIFICATIONS LIST PRICES AVAILABILITY: |
|---|----------------|---|
| DOUBLE ARTICULATING / SWIVEL TABLET ARM | | |
| <i>Overall: 14" Diameter .75"h</i> | | |
|  | ATA-L | \$983 <i>Tablet Arm With 360° Rotation - High Pressure Laminate. (Specify Laminate / Specify Left Or Right Facing Arm Location)</i> |
|  | ATA-V | \$1055 <i>Tablet Arm With 360° Rotation - Sunburst Cherry Veneer. (Specify Finish / Specify Left Or Right Facing Arm Location)</i> |
| | ATA-C | \$1173 <i>Tablet Arm With 360° Rotation - White Solid Surface. (Available In White Only / Specify Left Or Right Facing Arm Location)</i> |
| | CH-1 | \$129 <i>Black Plastic Cup Holder (Only Available If Used With Tablet Arm)</i> |
| | CH-2 | \$186 <i>Spun Aluminum Cup Holder (Only Available If Used With Tablet Arm)</i> |
| <i>Available: Facelift Replay Sleepover Lounge</i> | | |
| SIDE MOUNT / FOLD DOWN TABLET W/ LOCK & SWIVEL | | |
| <i>Overall: 14" Diameter .75"h</i> | | |
| | SMFDT-L | \$722 <i>Up & Away w/ Lock & High Pressure Laminate Top. (Specify Laminate / Specify Left Or Right Facing Arm Location)</i> |
| | SMFDT-V | \$1007 <i>Up & Away w/ Lock & Veneer Top. (Specify Finish / Specify Left Or Right Facing Arm Location)</i> |
| | SMFDT-C | \$1126 <i>Up & Away w/ Lock & White Solid Surface Top. (Available In White Only / Specify Left Or Right Facing Arm Location)</i> |
| <i>Available: Facelift Replay 1507, 1512, 1513, 1857, 1812, 1813</i> | | |
| LOCKING / NON-LOCKING CASTERS | | |
| <i>Overall: 1.875"w 2.25"d 1.5"h (Locking) / 1.875"w 1.625"d 1.5"h (Non-Locking)</i> | | |
|  | LC | \$44 (Set Of Two) <i>Locking Casters (Black Finish / Specify Location)</i> |
|  | NLC | \$37 (Set Of Two) <i>Non-Locking Casters (Black Finish / Specify Location)</i> |
| <i>Available: Facelift Replay Sleepover Lounge</i> | | |
| WALLSAVER - LOCKING / NON-LOCKING CASTERS | | |
| <i>Overall: 2.5"w 4"d 3.5"h (Locking) / 2.5"w 3.25"d 3.5"h (Non-Locking)</i> | | |
|  | WLC | \$199 List (Set Of Two) <i>Locking Swivel Casters (Gray Finish / Back Location)</i> |
|  | WNLC | \$185 List (Set Of Two) <i>Non-Locking / Non-Swivel Casters (Gray Finish / Front Location)</i> |
| <i>Note: Wallsaver Locking / Non-Locking Casters Cannot Be Used In Combination With Electric Recline.</i> | | |
| <i>Available: Facelift Wallsaver Recliners (1511 / 1811 / 1855 & Bariatric Versions)</i> | | |
| MEDICAL LOCKING / NON-LOCKING CASTERS | | |
| <i>Overall: 2.25"w 5"d 5.25"h (Locking) / 2"w 3.75"d 5.25"h (Non-Locking)</i> | | |
|  | MLC | \$194 (Set Of Two) <i>Locking Casters - Motion & Direction (Gray Finish / Specify Location)</i> |
|  | MNLC | \$224 (Set Of Two) <i>Non-Locking Casters - Single Direction (Gray Finish / Specify Location)</i> |
| <i>Available: Facelift Replay Electric Standup Recliner</i> | | |

| BRAKE / LEGS / POWER / ELECTRIC / PUSH BAR | OPTION #: | SPECIFICATIONS LIST PRICES AVAILABILITY: |
|---|--|---|
| CENTRAL BRAKING | | |
| <i>Overall: 7.5"w 2"d .5"h</i> | | |
|  | CB-1 | \$508 (Set Of 1) (Gray Plastic Brake w/ Lock & Unlock Pedals) <i>Available: Wallsavers / Infusion 1511 1514 1811 1814 1855 1865</i> |
| | CB-2 | \$510 (Set Of 1) (Gray Plastic Brake w/ Lock & Unlock Pedals) <i>Available: Layflat 1507-L/T 1513-L/T 1813 L/T 1857 L/T 1867 L/T</i> |
| ALUMINUM LEGS | | |
|  | ASL | <i>Overall: 2.25"w 2.25"d 2.25"h</i> \$382 (Set Of 4) (Brushed Finish) <i>Available: Facelift Replay Patient Chair / Glider (1508 / 1510 Models)</i> |
| | POWER / DATA MODULE | |
|  <p>PM1 Power / Data Module</p>  <p>PM2 Power Module</p>  <p>USB-1 Dual Charging USB</p> | PM1 | <i>PM1 Overall: 5.25"w 1.25"d 4.25"h</i> <i>PM2 Overall: 2"w 2"d .125"h</i> <i>USB-1 Overall: 2"w 2"d .125"h</i> \$859 Power/Data Module (1-Power / 1-USB 2 Port Simplex Charger Standard) <i>Vertical / Horizontal Mount Power Module. Price Varies By Socket. Contact Customer Service For Quote. (Additional Colors Available)</i> |
| | PM2 | \$238 Power Module (1-Power) <i>Spill-Proof Technology / Multiple Finish Options / Storm Color Standard (Specify Left or Right Facing)</i> |
| | USB-1 | \$238 Dual Charging USB (2 Port Simplex Charger Standard) <i>Spill-Proof Technology / 2 Amps Per Port / Multiple Finish Options / Storm Color Standard (Specify Left or Right Facing)</i> <i>Available: Facelift Replay Sleepover Lounge</i> |
| ELECTRIC RECLINE / BATTERY BACKUP / HEAT / MASSAGE | | |
| <i>Overall: N/A</i> | | |
|  <p>ER-1 Electric Recline (Wallsaver Model)</p>  <p>ER-2/ER-3 Electric Recline (Layflat Model)</p>  <p>BB</p>  <p>HM Heat & Massage (All Recliner Models)</p>  <p>H Heat (All Recliner Models)</p> | ER-1 | \$1054 Electric Recline <i>Replaces Manual Mechanism On Any Wallsaver Model - Surface Mounts On Inside Arm (Specify Left Or Right Facing)</i> <i>*NOTE: ELECTRIC OPTION NOT AVAILABLE ON INFUSION RECLINERS IN COMBINATION WITH CASTERS.</i> |
| | ER-2 | \$1087 Electric Recline <i>Replaces Manual Mechanism On Any Layflat Model - Surface Mounts On Inside Arm (Specify Left Or Right Facing)</i> |
| | ER-3 | \$1149 Electric Recline <i>Replaces Manual Mechanism On Any Trendelenburg Layflat Model - Surface Mounts On Inside Arm (Specify Left Or Right Facing)</i> |
| | BB | \$548 Battery Backup <i>Allows Any Wallsaver, Layflat, Or Standup Electric Recliner To Be Cordless - Surface Mounts On Inside Arm (Specify Left Or Right Facing)</i> |
| | HM | \$1500 Heat & Massage <i>Add Heat & Massage To Any Wallsaver, Layflat, Or Standup Electric Recliner - Surface Mounts On Inside Arm (Specify Left Or Right Facing)</i> |
| H | \$1142 Heat <i>Add Heat Only To Any Wallsaver, Layflat, Or Standup Electric Recliner - Surface Mounts On Inside Arm (Specify Left Or Right Facing)</i> <i>Available: Facelift Replay Recliners</i> | |
| PUSH BAR | | |
| <i>Overall: 18.5"w 3.5"d 1"h</i> | | |
|  | PB | \$267 (Black Finish) <i>Available: Facelift Replay Medical Recliners</i> |

| I.V. POLE / SIDE TRAY / BAG HOLDER / BUCKLE / FOOTREST | OPTION #: | SPECIFICATIONS LIST PRICES AVAILABILITY: |
|---|---|--|
| <p>I.V. POLE</p>  | <p>IV</p> <p>Overall: 10"w 2.5"d 39.5" / 69.75"h</p> <p>\$489 Height Adjustable I.V. Pole (Chrome & Black Finish / Specify Left Or Right Facing Location)</p> <p>Available: Facelift Replay Medical Recliners</p> | |
| <p>SIDE TRAY / WALLSAVER SIDE TRAY</p>   | <p>Overall: 12.75"w 10"d 4"h (Small Side Tray) / 17"w 10"d 4"h (Large Side Tray)</p> <p>ST-1 \$368 Drop-Down Side Tray (Small Side Tray) <i>NOTE: Attaches Directly To Outside Of Arm</i></p> <p>ST-2 \$415 Drop-Down Side Tray (Large Side Tray) <i>NOTE: Attaches Directly To Outside Of Arm</i></p> <p>Available: Facelift Replay Medical Recliners <i>Note: If A Medical Recliner With A Manual Mechanism Is Selected, The Standard Side Tray Location Will Be Front Right Facing</i></p> <p>WST \$598 Drop-Down Side Tray (Large Side Tray) <i>NOTE: Attaches To Metal Tubing</i></p> <p>Available: Facelift Wallsaver Recliners With Casters Option (1511 / 1811 / 1855)</p> | |
| <p>BAG HOLDER / PERSONAL RESTRAINT BUCKLE</p>  | <p>Overall: 2.19"w .38"d 2.56"h</p> <p>BH \$86 Bag Holder (Brushed Finish / Specify Left Or Right Facing Location)</p> <p>RB \$133 Pair Personal Restraint Buckle (Brushed Finish)</p> <p>Available: Facelift Replay Medical Recliners</p> | |
| <p>FOOTREST</p>  | <p>Overall: 16"w 8"d .1875"h</p> <p>FR \$408 (Black Finish)</p> <p>Available: Facelift Replay Medical Recliners</p> | |

| OXYGEN TANK HOLDER / WOOD RING BASE / COVERS | OPTION #: | SPECIFICATIONS LIST PRICES AVAILABILITY: |
|--|--|--|
| <p>OXYGEN TANK HOLDER</p>  | <p>OH</p> <p>Overall: 4.75" Diameter 9.75"h</p> <hr/> <p>\$247 <i>Black Metal Oxygen Tank Holder Holds a 4.375" Diameter Oxygen Tank (Not Included) (Specify Left Or Right Facing Location)</i></p> <p>Available: <i>Facelift Replay Medical Recliners</i></p> | |
| <p>LOUNGE GLIDER WOOD RING BASE</p>  | <p>WR</p> <p>Overall: 22"dia. 3"h</p> <hr/> <p>\$224 <i>Wood Ring Base replaces circular metal base (1510-G) or swivel glider w/ circular metal base (1510-SG).</i></p> <p><i>Specify Exposed Wood Finish. (See Page 6)</i></p> <p>Available: <i>Facelift Replay Lounge Glider</i></p> | |
| <p>CONTRASTING COVERS</p>  | <p>CC</p> <p>Overall: N/A</p> <hr/> <p>\$129 <i>NOTE: If Two Or More Upholsteries Or Leathers Are Used On Any Piece Of Furniture, Then A Contrast Charge Will Apply Per Order. When Using Trinity Upholstery, The Higher Priced Upholstery Grade Will Be Used In Pricing, Unless It's Trinity Leather With Fabric Contrast Welt, Or COM With Trinity Contrast Welt, Then Contact Customer Service For Pricing.</i></p> <p>Available: <i>Facelift Replay Healthcare Motion</i></p> | |

Facelift Polliwogs

BENCHES / OTTOMANS / TABLES

Effective: March 1, 2025

T R I N I T Y

Date:

Page:

Modification:

Description:

DESCRIPTION:

- Upholstery Frames: Hardwood Plywood
- Seat: High Density Polyurethane Foam Over Hardwood Plywood
- Upholstered Covers: Attached w/ Velcro / Removable For Maintenance
- Antimicrobial Moisture Barrier Fully Encapsulates All Foam Areas
- Round Black Plastic Feet / Removable For Maintenance
- Ganging Connectors Standard
- Leather Upholstery Is Available
- Lifetime Warranty

OPTIONS:

- LC Locking Casters (Set Of 2)\$31
- NLC Non-Locking Casters (Set Of 2).....\$26
- CC Contrasting Covers\$129

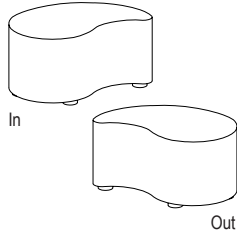
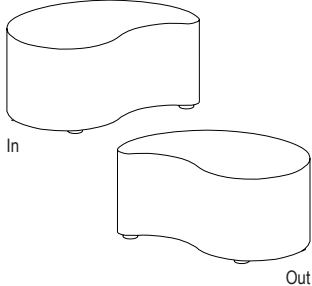
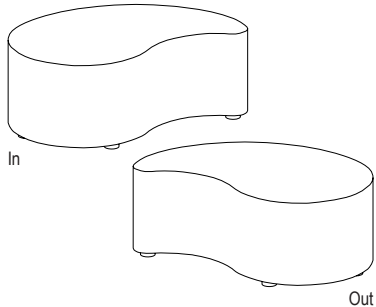
| BENCHES | | ITEM #: | SPECIFICATIONS GRADES LIST PRICES: | | | | | | | | | | | | | | |
|--|--|---------------|---|------------|----------|----------|-------------------------|----------|----------|----------|-----------------------|----------|----------|-----------|-----------|-----------|--|
| SMALL BENCH / FULLY UPHOLSTERED | | | Overall: 18"w 30"d 14"h | | | | Arm: n/a | | | | COM: 2.75 yds. | | | | | | |
| | | | Seat: 14"h | | | | Weight: TBD lbs. | | | | COL: 50 sq.ft. | | | | | | |
|  | | | COM | COL | 1 | 2 | 3 | 4 | 5 | 6 | 7 | 8 | 9 | 10 | L1 | L2 | |
| | | 1540-I | 732 | 805 | 836 | 908 | 980 | 1052 | 1125 | 1197 | 1269 | 1341 | 1413 | 1485 | 1570 | 1830 | |
| | | | <i>Small Size - In / Tight Seat / Removable Upholstery / 350 lb. Weight Capacity</i> | | | | | | | | | | | | | | |
| | | 1540-O | 732 | 805 | 836 | 908 | 980 | 1052 | 1125 | 1197 | 1269 | 1341 | 1413 | 1485 | 1570 | 1830 | |
| | <i>Small Size - Out / Tight Seat / Removable Upholstery / 350 lb. Weight Capacity</i> | | | | | | | | | | | | | | | | |
| | 1540-I/O R | 169 | 185 | 317 | 396 | 475 | 555 | 634 | 713 | 792 | 871 | 950 | 1029 | 1106 | 1391 | | |
| | <i>Replacement Upholstery Covers</i> | | | | | | | | | | | | | | | | |
| MEDIUM BENCH / FULLY UPHOLSTERED | | | Overall: 24"w 40"d 18"h | | | | Arm: n/a | | | | COM: 3.00 yds. | | | | | | |
| | | | Seat: 18"h | | | | Weight: TBD lbs. | | | | COL: 54 sq.ft. | | | | | | |
|  | | | COM | COL | 1 | 2 | 3 | 4 | 5 | 6 | 7 | 8 | 9 | 10 | L1 | L2 | |
| | | 1541-I | 1029 | 1132 | 1132 | 1211 | 1291 | 1370 | 1450 | 1529 | 1608 | 1688 | 1767 | 1846 | 1940 | 2226 | |
| | | | <i>Medium Size - In / Tight Seat / Removable Upholstery / 350 lb. Weight Capacity</i> | | | | | | | | | | | | | | |
| | | 1541-O | 1029 | 1132 | 1132 | 1211 | 1291 | 1370 | 1450 | 1529 | 1608 | 1688 | 1767 | 1846 | 1940 | 2226 | |
| | <i>Medium Size - Out / Tight Seat / Removable Upholstery / 350 lb. Weight Capacity</i> | | | | | | | | | | | | | | | | |
| | 1541-I/O R | 199 | 219 | 362 | 449 | 536 | 623 | 709 | 796 | 883 | 970 | 1057 | 1144 | 1230 | 1543 | | |
| | <i>Replacement Upholstery Covers</i> | | | | | | | | | | | | | | | | |
| LARGE BENCH / FULLY UPHOLSTERED | | | Overall: 30"w 50"d 18"h | | | | Arm: n/a | | | | COM: 3.25 yds. | | | | | | |
| | | | Seat: 18"h | | | | Weight: TBD lbs. | | | | COL: 59 sq.ft. | | | | | | |
|  | | | COM | COL | 1 | 2 | 3 | 4 | 5 | 6 | 7 | 8 | 9 | 10 | L1 | L2 | |
| | | 1542-I | 1352 | 1487 | 1451 | 1538 | 1624 | 1711 | 1798 | 1884 | 1971 | 2057 | 2144 | 2231 | 2334 | 2645 | |
| | | | <i>Large Size - In / Tight Seat / Removable Upholstery / 350 lb. Weight Capacity</i> | | | | | | | | | | | | | | |
| | | 1542-O | 1352 | 1487 | 1451 | 1538 | 1624 | 1711 | 1798 | 1884 | 1971 | 2057 | 2144 | 2231 | 2334 | 2645 | |
| | <i>Large Size - Out / Tight Seat / Removable Upholstery / 350 lb. Weight Capacity</i> | | | | | | | | | | | | | | | | |
| | 1542-I/O R | 223 | 245 | 400 | 495 | 590 | 685 | 780 | 875 | 969 | 1064 | 1159 | 1254 | 1348 | 1690 | | |
| | <i>Replacement Upholstery Covers</i> | | | | | | | | | | | | | | | | |

DESCRIPTION:

- Upholstery Frames: Hardwood Plywood
- Seat: High Density Polyurethane Foam Over Hardwood Plywood
- Upholstered Covers: Attached w/ Velcro / Removable For Maintenance
- Antimicrobial Moisture Barrier Fully Encapsulates All Foam Areas
- Round Black Plastic Feet / Removable For Maintenance
- Ganging Connectors Standard
- Leather Upholstery Is Available
- Lifetime Warranty

OPTIONS:

- LC Locking Casters (Set Of 2)\$44
- NLC Non-Locking Casters (Set Of 2).....\$37
- CC Contrasting Covers\$129

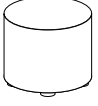
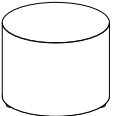
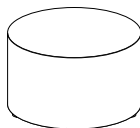
| OTTOMANS | | ITEM #: | SPECIFICATIONS GRADES LIST PRICES: | | | | | | | | | | | | | |
|---|--|--|--|-----|-----|--|------|------|--|------|------|------|------|------|------|------|
|  | SMALL ROUND OTTOMAN / FULLY UPHOLSTERED | | Overall: 18" Diameter 14"h Seat: 14"h | | | Arm: n/a Weight: TBD lbs. | | | COM: 2.00 yds. COL: 36 sq.ft. | | | | | | | |
| | | | COM | COL | 1 | 2 | 3 | 4 | 5 | 6 | 7 | 8 | 9 | 10 | L1 | L2 |
| | 1543-18D | | 483 | 532 | 558 | 608 | 659 | 709 | 760 | 810 | 861 | 911 | 962 | 1012 | 1066 | 1248 |
| | | <i>Small Size / Tight Seat / Removable Upholstery / 350 lb. Weight Capacity</i> | | | | | | | | | | | | | | |
| | 1543-18DR | | 102 | 113 | 207 | 263 | 318 | 373 | 429 | 484 | 539 | 595 | 650 | 705 | 756 | 955 |
| | | <i>Replacement Upholstery Covers</i> | | | | | | | | | | | | | | |
|  | MEDIUM ROUND OTTOMAN / FULLY UPHOLSTERED | | Overall: 24" Diameter 18"h Seat: 18"h | | | Arm: n/a Weight: 46 lbs. | | | COM: 2.25 yds. COL: 41 sq.ft. | | | | | | | |
| | | | COM | COL | 1 | 2 | 3 | 4 | 5 | 6 | 7 | 8 | 9 | 10 | L1 | L2 |
| | 1543-24D | | 738 | 812 | 813 | 871 | 929 | 986 | 1044 | 1102 | 1159 | 1217 | 1275 | 1333 | 1394 | 1602 |
| | | <i>Medium Size / Tight Seat / Removable Upholstery / 350 lb. Weight Capacity</i> | | | | | | | | | | | | | | |
| | 1543-24DR | | 120 | 132 | 240 | 303 | 366 | 429 | 492 | 556 | 619 | 682 | 745 | 809 | 866 | 1094 |
| | | <i>Replacement Upholstery Covers</i> | | | | | | | | | | | | | | |
|  | LARGE ROUND OTTOMAN / FULLY UPHOLSTERED | | Overall: 30" Diameter 18"h Seat: 18"h | | | Arm: n/a Weight: TBD lbs. | | | COM: 2.50 yds. COL: 45 sq.ft. | | | | | | | |
| | | | COM | COL | 1 | 2 | 3 | 4 | 5 | 6 | 7 | 8 | 9 | 10 | L1 | L2 |
| | 1543-30D | | 868 | 955 | 951 | 1016 | 1081 | 1146 | 1211 | 1276 | 1341 | 1406 | 1471 | 1535 | 1606 | 1840 |
| | | <i>Large Size / Tight Seat / Removable Upholstery / 350 lb. Weight Capacity</i> | | | | | | | | | | | | | | |
| | 1543-30DR | | 144 | 158 | 278 | 349 | 420 | 492 | 563 | 634 | 705 | 776 | 847 | 918 | 984 | 1240 |
| | | <i>Replacement Upholstery Covers</i> | | | | | | | | | | | | | | |

DESCRIPTION:

- Upholstery Frames: Hardwood Plywood
- Table Top: High Pressure Laminate Top Over Plywood Core
- Upholstered Covers: Attached w/ Velcro / Removable For Maintenance
- Antimicrobial Moisture Barrier Fully Encapsulates All Foam Areas
- Round Black Plastic Feet / Removable For Maintenance
- Ganging Connectors Standard
- Leather Upholstery Is Available
- Lifetime Warranty

OPTIONS:

- SE18D Self Edge Table Top - 18" Diameter.....\$38
- SE24D Self Edge Table Top - 24" Diameter.....\$38
- SE30D Self Edge Table Top - 30" Diameter.....\$38
- LC Locking Casters (Set Of 2).....\$44
- NLC Non-Locking Casters (Set Of 2).....\$37
- CC Contrasting Covers.....\$129

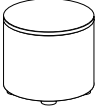
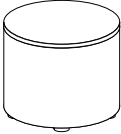
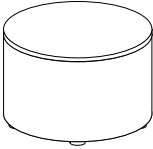
| TABLES | | ITEM #: | SPECIFICATIONS GRADES LIST PRICES: | | | | | | | | | | | | |
|---|--|--|--|------------|----------|----------|-------------------------|----------|----------|----------|-----------------------|----------|----------|-----------|-----------|
|  | SMALL ROUND TABLE / UPHOLSTERED BASE | | Overall: 18" Diameter 14"h | | | | Arm: n/a | | | | COM: 1.25 yds. | | | | |
| | | | Seat: 14"h | | | | Weight: TBD lbs. | | | | COL: 23 sq.ft. | | | | |
| | | | COM | COL | 1 | 2 | 3 | 4 | 5 | 6 | 7 | 8 | 9 | 10 | L1 |
| | 1544-18T | 594 | 654 | 620 | 649 | 677 | 706 | 735 | 764 | 793 | 822 | 851 | 879 | 918 | 1022 |
| | | <i>Small Size / High Pressure Laminate Top / Removable Upholstery</i> | | | | | | | | | | | | | |
| | 1544-18TR | 102 | 113 | 160 | 192 | 223 | 255 | 287 | 318 | 350 | 381 | 413 | 445 | 478 | 592 |
| | | <i>Replacement Upholstery Covers</i> | | | | | | | | | | | | | |
|  | MEDIUM ROUND TABLE / UPHOLSTERED BASE | | Overall: 24" Diameter 18"h | | | | Arm: n/a | | | | COM: 1.50 yds. | | | | |
| | | | Seat: 18"h | | | | Weight: TBD lbs. | | | | COL: 27 sq.ft. | | | | |
| | | | COM | COL | 1 | 2 | 3 | 4 | 5 | 6 | 7 | 8 | 9 | 10 | L1 |
| | 1544-24T | 900 | 990 | 923 | 959 | 995 | 1032 | 1068 | 1104 | 1140 | 1176 | 1212 | 1248 | 1294 | 1424 |
| | | <i>Medium Size / High Pressure Laminate Top / Removable Upholstery</i> | | | | | | | | | | | | | |
| | 1544-24TR | 120 | 132 | 192 | 232 | 271 | 311 | 350 | 390 | 429 | 469 | 508 | 548 | 589 | 731 |
| | | <i>Replacement Upholstery Covers</i> | | | | | | | | | | | | | |
|  | LARGE ROUND TABLE / UPHOLSTERED BASE | | Overall: 30" Diameter 18"h | | | | Arm: n/a | | | | COM: 1.75 yds. | | | | |
| | | | Seat: 18"h | | | | Weight: TBD lbs. | | | | COL: 32 sq.ft. | | | | |
| | | | COM | COL | 1 | 2 | 3 | 4 | 5 | 6 | 7 | 8 | 9 | 10 | L1 |
| | 1544-30T | 1070 | 1177 | 1084 | 1120 | 1156 | 1192 | 1228 | 1264 | 1300 | 1336 | 1372 | 1408 | 1037 | 1589 |
| | | <i>Large Size / High Pressure Laminate Top / Removable Upholstery</i> | | | | | | | | | | | | | |
| | 1544-30TR | 144 | 158 | 231 | 278 | 326 | 373 | 420 | 468 | 515 | 563 | 610 | 658 | 152 | 757 |
| | | <i>Replacement Upholstery Covers</i> | | | | | | | | | | | | | |

DESCRIPTION:

- Upholstery Frames: Hardwood Plywood
- Table Top: High Pressure Laminate Top Over Plywood Core
- Upholstered Covers: Attached w/ Velcro / Removable For Maintenance
- Antimicrobial Moisture Barrier Fully Encapsulates All Foam Areas
- Round Black Plastic Feet / Removable For Maintenance
- Ganging Connectors Standard
- Leather Upholstery Is Available
- Lifetime Warranty

OPTIONS:

- SE18D Self Edge Table Top - 18" Diameter.....\$38
- SE24D Self Edge Table Top - 24" Diameter.....\$38
- SE30D Self Edge Table Top - 30" Diameter.....\$38
- LC Locking Casters (Set Of 2).....\$44
- NLC Non-Locking Casters (Set Of 2).....\$37
- CC Contrasting Covers.....\$129

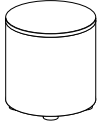
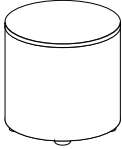
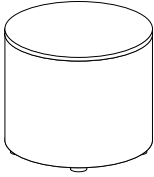
| TABLES | | ITEM #: | SPECIFICATIONS GRADES LIST PRICES: | | | | | | | | | | | | | |
|---|------------------|--|--|------------|----------|----------|----------|----------|----------|----------|----------|----------|----------|-----------|-----------|-----------|
| <p>TALL SMALL ROUND TABLE / UPHOLSTERED BASE</p>  | | <p>Overall: 18" Diameter 18"h Seat: 18"h</p> <p>Arm: n/a Weight: 35 lbs.</p> <p>COM: 1.25 yds. COL: 23 sq.ft.</p> | COM | COL | 1 | 2 | 3 | 4 | 5 | 6 | 7 | 8 | 9 | 10 | L1 | L2 |
| | 1545-18T | 651 716 673 702 731 759 788 817 846 875 904 933 973 1077 | <i>Small Size / High Pressure Laminate Top / Removable Upholstery</i> | | | | | | | | | | | | | |
| | 1545-18TR | 109 120 167 198 230 262 293 325 356 388 420 451 486 600 | <i>Replacement Upholstery Covers</i> | | | | | | | | | | | | | |
| <p>TALL MEDIUM ROUND TABLE / UPHOLSTERED BASE</p>  | | <p>Overall: 24" Diameter 24"h Seat: 24"h</p> <p>Arm: n/a Weight: TBD lbs.</p> <p>COM: 1.50 yds. COL: 27 sq.ft.</p> | COM | COL | 1 | 2 | 3 | 4 | 5 | 6 | 7 | 8 | 9 | 10 | L1 | L2 |
| | 1545-24T | 810 891 838 874 910 946 982 1018 1054 1091 1127 1163 1211 1341 | <i>Medium Size / High Pressure Laminate Top / Removable Upholstery</i> | | | | | | | | | | | | | |
| | 1545-24TR | 127 139 199 238 278 317 357 396 436 475 515 554 597 739 | <i>Replacement Upholstery Covers</i> | | | | | | | | | | | | | |
| <p>TALL LARGE ROUND TABLE / UPHOLSTERED BASE</p>  | | <p>Overall: 30" Diameter 24"h Seat: 24"h</p> <p>Arm: n/a Weight: TBD lbs.</p> <p>COM: 1.75 yds. COL: 32 sq.ft.</p> | COM | COL | 1 | 2 | 3 | 4 | 5 | 6 | 7 | 8 | 9 | 10 | L1 | L2 |
| | 1545-30T | 1090 1199 1117 1160 1203 1247 1290 1333 1377 1420 1463 1506 1564 1720 | <i>Large Size / High Pressure Laminate Top / Removable Upholstery</i> | | | | | | | | | | | | | |
| | 1545-30TR | 151 166 237 285 332 380 427 475 522 569 617 664 715 886 | <i>Replacement Upholstery Covers</i> | | | | | | | | | | | | | |

CONFIGURATION EXAMPLES:

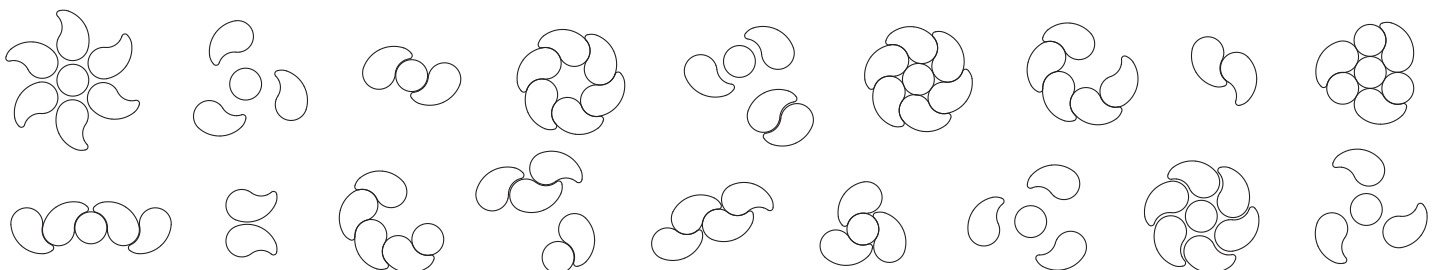

| POWER / COVERS | OPTION #: | SPECIFICATIONS LIST PRICES AVAILABILITY: |
|---|--|--|
| <p>LOCKING / NON-LOCKING CASTERS</p>  <p>Locking Casters</p>  <p>Non-Locking Casters</p> | <p>Overall: 1.875"w 2.25"d 1.5"h (Locking) / 1.875"w 1.625"d 1.5"h (Non-Locking)</p> <hr/> <p>LC \$44 (Set Of Two) <i>Locking Casters (Black Finish / Specify Location)</i></p> <p>NLC \$37 (Set Of Two) <i>Non-Locking Casters (Black Finish / Specify Location)</i></p> <p>Available: <i>Facelift Polliwogs Collection</i></p> | |
| <p>SELF EDGE TABLE TOP</p>  | <p>Overall: 18" Diameter x 1"h / 24" Diameter x 1"h / 30" Diameter x 1"h</p> <hr/> <p>SE18D Self Edge Table Top - 18" Diameter \$38</p> <p>SE24D Self Edge Table Top - 24" Diameter \$38</p> <p>SE30D Self Edge Table Top - 30" Diameter \$38</p> <p><i>High Pressure Laminate Top w/ Self Edge</i></p> <p>Available: <i>Facelift Polliwogs Tables</i></p> | |
| <p>CONTRASTING COVERS</p>  | <p>Overall: N/A</p> <hr/> <p>CC \$129</p> <p><i>NOTE: If Two Or More Upholsteries Or Leathers Are Used On Any Piece Of Furniture, Then A Contrast Charge Will Apply Per Order. When Using Trinity Upholstery, The Higher Priced Upholstery Grade Will Be Used In Pricing, Unless It's Trinity Leather With Fabric Contrast Welt, Or COM With Trinity Contrast Welt, Then Contact Customer Service For Pricing.</i></p> <p>Available: <i>Facelift Polliwogs Collection</i></p> | |

Facelift Fair & Square

LOUNGE / TANDEM / BENCHES / TABLES

Effective: March 1, 2025

T R I N I T Y

Date:

Page:

Modification:

Description:

DESCRIPTION:

- Upholstery Frames: Plywood & Hardwood
- Seat: High Density Polyurethane Foam Over Sheet Webbing
- Upholstered Covers: Attached w/ Velcro / Removable For Maintenance
- Antimicrobial Moisture Barrier Fully Encapsulates All Foam Areas
- Ganging Straps Standard
- Brushed Aluminum Round Legs / Removable For Maintenance
- Leather Upholstery Is Available
- Lifetime Warranty

OPTIONS:

- USB-1 USB In Back (2 Ports Available - Specify Left or Right Facing).....\$238
- PM2 Power Module (1-Power - Specify Left or Right Facing).....\$238

Feather Down & Polyester Pillows Available (See Page 5)

NOTE: Additional Seaming May Be Required If Fabric Is Railroaded.

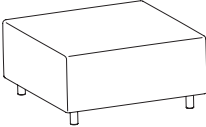
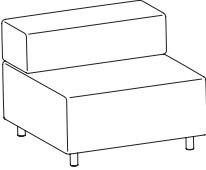
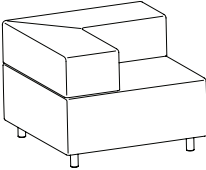
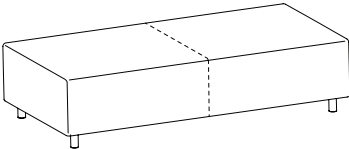
| TANDEM | | ITEM #: | SPECIFICATIONS GRADES LIST PRICES: | | | | | | | | | | | | | |
|---|---------------|---------|---|------------|----------|-------------------------|----------|----------|-----------------------|----------|----------|----------|----------|-----------|-----------|-----------|
|  | | | Overall: 36"w 36"d 18"h | | | Arm: n/a | | | COM: 2.5 yds. | | | | | | | |
| | | | Seat: 36"w 36"d 18"h | | | Weight: 62 lbs. | | | COL: 45 sq.ft. | | | | | | | |
| | | | COM | COL | 1 | 2 | 3 | 4 | 5 | 6 | 7 | 8 | 9 | 10 | L1 | L2 |
| | 1550 | | 1051 | 1156 | 1195 | 1296 | 1397 | 1498 | 1599 | 1700 | 1801 | 1902 | 2004 | 2105 | 2199 | 2563 |
| | | | <i>Tight Seat / Removable Upholstery / 500 lb. Weight Capacity</i> | | | | | | | | | | | | | |
| | 1550-R | | 135 | 148 | 269 | 341 | 412 | 483 | 554 | 625 | 696 | 767 | 839 | 910 | 975 | 1231 |
| | | | <i>Replacement Upholstery Covers</i> | | | | | | | | | | | | | |
|  | | | Overall: 36"w 36"d 28"h | | | Arm: n/a | | | COM: 3.25 yds. | | | | | | | |
| | | | Seat: 36"w 22"d 18"h | | | Weight: 70 lbs. | | | COL: 59 sq.ft. | | | | | | | |
| | | | COM | COL | 1 | 2 | 3 | 4 | 5 | 6 | 7 | 8 | 9 | 10 | L1 | L2 |
| | 1551 | | 1461 | 1607 | 1555 | 1641 | 1728 | 1815 | 1901 | 1988 | 2074 | 2161 | 2248 | 2334 | 2428 | 2740 |
| | | | <i>Tight Seat & Back / Removable Upholstery / 500 lb. Weight Capacity</i> | | | | | | | | | | | | | |
| | 1551-R | | 184 | 203 | 364 | 459 | 554 | 648 | 743 | 838 | 933 | 1028 | 1123 | 1218 | 1304 | 1645 |
| | | | <i>Replacement Upholstery Covers</i> | | | | | | | | | | | | | |
|  | | | Overall: 36"w 36"d 28"h | | | Arm: n/a | | | COM: 4 yds. | | | | | | | |
| | | | Seat: 36"w 22"d 18"h | | | Weight: 74 lbs. | | | COL: 72 sq.ft. | | | | | | | |
| | | | COM | COL | 1 | 2 | 3 | 4 | 5 | 6 | 7 | 8 | 9 | 10 | L1 | L2 |
| | 1552 | | 1673 | 1840 | 1798 | 1906 | 2014 | 2123 | 2231 | 2339 | 2447 | 2556 | 2664 | 2772 | 2892 | 3281 |
| | | | <i>Tight Seat & Back / Removable Upholstery / 500 lb. Weight Capacity</i> | | | | | | | | | | | | | |
| | 1552-R | | 243 | 267 | 467 | 585 | 704 | 822 | 941 | 1059 | 1178 | 1297 | 1415 | 1534 | 1645 | 2072 |
| | | | <i>Replacement Upholstery Covers</i> | | | | | | | | | | | | | |
|  | | | Overall: 72"w 36"d 18"h | | | Arm: n/a | | | COM: 4.5 yds. | | | | | | | |
| | | | Seat: 72"w 36"d 18"h | | | Weight: 121 lbs. | | | COL: 81 sq.ft. | | | | | | | |
| | | | COM | COL | 1 | 2 | 3 | 4 | 5 | 6 | 7 | 8 | 9 | 10 | L1 | L2 |
| | 1555 | | 1525 | 1677 | 1687 | 1809 | 1932 | 2055 | 2177 | 2300 | 2423 | 2545 | 2668 | 2791 | 2909 | 3351 |
| | | | <i>Tight Seat / Removable Upholstery / 750 lb. Weight Capacity</i> | | | | | | | | | | | | | |
| | 1555-R | | 208 | 229 | 465 | 599 | 734 | 868 | 1003 | 1137 | 1271 | 1406 | 1540 | 1674 | 1787 | 2271 |
| | | | <i>Replacement Upholstery Covers</i> | | | | | | | | | | | | | |

DESCRIPTION:

- Upholstery Frames: Plywood & Hardwood
- Seat: High Density Polyurethane Foam Over Sheet Webbing
- Upholstered Covers: Attached w/ Velcro / Removable For Maintenance
- Antimicrobial Moisture Barrier Fully Encapsulates All Foam Areas
- Ganging Straps Standard
- Brushed Aluminum Round Legs / Removable For Maintenance
- Leather Upholstery Is Available
- Lifetime Warranty

OPTIONS:

- USB-1 USB In Back (2 Ports Available - Specify Left or Right Facing).....\$238
- PM2 Power Module (1-Power - Specify Left or Right Facing).....\$238

Feather Down & Polyester Pillows Available (See Page 5)

NOTE: Additional Seaming May Be Required If Fabric Is Railroaded.

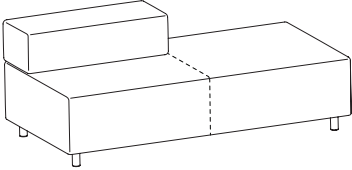
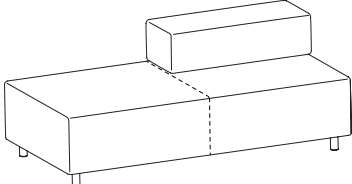
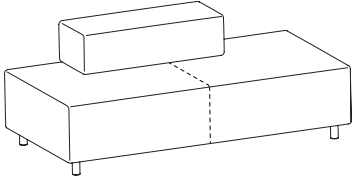
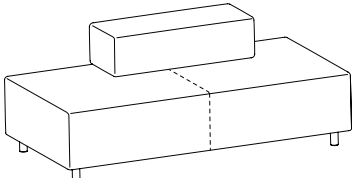
| TANDEM | | ITEM #: | SPECIFICATIONS GRADES LIST PRICES: | | | | | | | | | | | | | |
|---|---------------|---------|---|------------|----------|-------------------------|----------|----------|-----------------------|----------|----------|----------|----------|-----------|-----------|-----------|
|  | | | Overall: 72"w 36"d 28"h | | | Arm: n/a | | | COM: 5.25 yds. | | | | | | | |
| | | | Seat: 72"w 22"/36"d 18"h | | | Weight: 129 lbs. | | | COL: 95 sq.ft. | | | | | | | |
| | | | COM | COL | 1 | 2 | 3 | 4 | 5 | 6 | 7 | 8 | 9 | 10 | L1 | L2 |
| | 1556 | | 2063 | 2269 | 2239 | 2383 | 2527 | 2672 | 2816 | 2960 | 3105 | 3249 | 3393 | 3538 | 3683 | 4203 |
| | | | <i>Tight Seat & Back / Removable Upholstery / 750 lb. Weight Capacity</i> | | | | | | | | | | | | | |
| | 1556-R | | 271 | 298 | 573 | 731 | 889 | 1047 | 1205 | 1363 | 1521 | 1679 | 1837 | 1995 | 2131 | 2700 |
| | | | <i>Replacement Upholstery Covers</i> | | | | | | | | | | | | | |
|  | | | Overall: 72"w 36"d 28"h | | | Arm: n/a | | | COM: 5.25 yds. | | | | | | | |
| | | | Seat: 72"w 22"/36"d 18"h | | | Weight: 129 lbs. | | | COL: 95 sq.ft. | | | | | | | |
| | | | COM | COL | 1 | 2 | 3 | 4 | 5 | 6 | 7 | 8 | 9 | 10 | L1 | L2 |
| | 1557 | | 2063 | 2269 | 2239 | 2383 | 2527 | 2672 | 2816 | 2960 | 3105 | 3249 | 3393 | 3538 | 3683 | 4203 |
| | | | <i>Tight Seat & Back / Removable Upholstery / 750 lb. Weight Capacity</i> | | | | | | | | | | | | | |
| | 1557-R | | 271 | 298 | 573 | 731 | 889 | 1047 | 1205 | 1363 | 1521 | 1679 | 1837 | 1995 | 2131 | 2700 |
| | | | <i>Replacement Upholstery Covers</i> | | | | | | | | | | | | | |
|  | | | Overall: 72"w 36"d 28"h | | | Arm: n/a | | | COM: 5.25 yds. | | | | | | | |
| | | | Seat: 72"w 22"d 18"h | | | Weight: 129 lbs. | | | COL: 95 sq.ft. | | | | | | | |
| | | | COM | COL | 1 | 2 | 3 | 4 | 5 | 6 | 7 | 8 | 9 | 10 | L1 | L2 |
| | 1558 | | 2069 | 2276 | 2245 | 2389 | 2533 | 2678 | 2822 | 2966 | 3110 | 3255 | 3399 | 3543 | 3689 | 4208 |
| | | | <i>Tight Seat & Back / Removable Upholstery / 750 lb. Weight Capacity</i> | | | | | | | | | | | | | |
| | 1558-R | | 271 | 298 | 573 | 731 | 889 | 1047 | 1205 | 1363 | 1521 | 1679 | 1837 | 1995 | 2131 | 2700 |
| | | | <i>Replacement Upholstery Covers</i> | | | | | | | | | | | | | |
|  | | | Overall: 72"w 36"d 28"h | | | Arm: n/a | | | COM: 5.25 yds. | | | | | | | |
| | | | Seat: 72"w 22"d 18"h | | | Weight: 129 lbs. | | | COL: 95 sq.ft. | | | | | | | |
| | | | COM | COL | 1 | 2 | 3 | 4 | 5 | 6 | 7 | 8 | 9 | 10 | L1 | L2 |
| | 1559 | | 2069 | 2276 | 2245 | 2389 | 2533 | 2678 | 2822 | 2966 | 3110 | 3255 | 3399 | 3543 | 3689 | 4208 |
| | | | <i>Tight Seat & Back / Removable Upholstery / 750 lb. Weight Capacity</i> | | | | | | | | | | | | | |
| | 1559-R | | 271 | 298 | 573 | 731 | 889 | 1047 | 1205 | 1363 | 1521 | 1679 | 1837 | 1995 | 2131 | 2700 |
| | | | <i>Replacement Upholstery Covers</i> | | | | | | | | | | | | | |

DESCRIPTION:

- Upholstery Frames: Plywood & Hardwood
- Seat: High Density Polyurethane Foam Over Sheet Webbing
- Upholstered Covers: Attached w/ Velcro / Removable For Maintenance
- Antimicrobial Moisture Barrier Fully Encapsulates All Foam Areas
- Ganging Straps Standard
- Brushed Aluminum Round Legs / Removable For Maintenance
- Leather Upholstery Is Available
- Lifetime Warranty

OPTIONS:

- USB-1 USB In Back (2 Ports Available - Specify Left or Right Facing).....\$238
- PM2 Power Module (1-Power - Specify Left or Right Facing).....\$238

Feather Down & Polyester Pillows Available (See Page 5)

NOTE: Additional Seaming May Be Required If Fabric Is Railroaded.

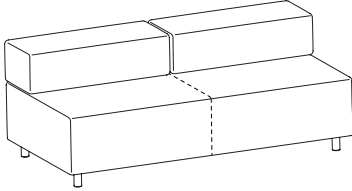
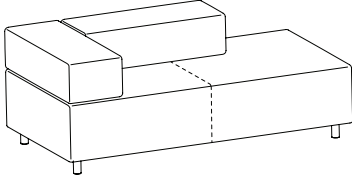
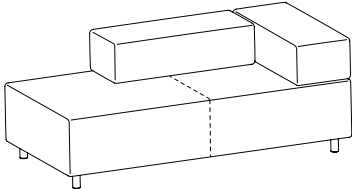
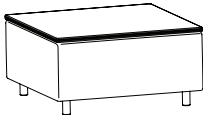
| TANDEM | ITEM #: | SPECIFICATIONS GRADES LIST PRICES: | | | | | | | | | | | | | |
|---|---------------|---|------------|-------------------------|----------|------------------------|----------|----------|----------|----------|----------|----------|-----------|-----------|-----------|
|  | | Overall: 72"w 36"d 28"h | | Arm: n/a | | COM: 6 yds. | | | | | | | | | |
| | | Seat: 72"w 22"d 18"h | | Weight: 137 lbs. | | COL: 108 sq.ft. | | | | | | | | | |
| | | COM | COL | 1 | 2 | 3 | 4 | 5 | 6 | 7 | 8 | 9 | 10 | L1 | L2 |
| | 1560 | 2439 | 2683 | 2638 | 2804 | 2970 | 3136 | 3302 | 3468 | 3634 | 3800 | 3966 | 4132 | 4318 | 4915 |
| | | <i>Tight Seat & Back / Removable Upholstery / 750 lb. Weight Capacity</i> | | | | | | | | | | | | | |
| | 1560-R | 294 | 323 | 641 | 823 | 1005 | 1187 | 1369 | 1550 | 1732 | 1914 | 2096 | 2277 | 2435 | 3090 |
| | | <i>Replacement Upholstery Covers</i> | | | | | | | | | | | | | |
|  | | Overall: 72"w 36"d 28"h | | Arm: n/a | | COM: 6 yds. | | | | | | | | | |
| | | Seat: 72"w 22"/36"d 18"h | | Weight: 137 lbs. | | COL: 108 sq.ft. | | | | | | | | | |
| | | COM | COL | 1 | 2 | 3 | 4 | 5 | 6 | 7 | 8 | 9 | 10 | L1 | L2 |
| | 1561 | 2476 | 2724 | 2673 | 2839 | 3005 | 3171 | 3337 | 3503 | 3669 | 3835 | 4001 | 4167 | 4352 | 4950 |
| | | <i>Tight Seat & Back / Removable Upholstery / 750 lb. Weight Capacity</i> | | | | | | | | | | | | | |
| | 1561-R | 294 | 323 | 641 | 823 | 1005 | 1187 | 1369 | 1550 | 1732 | 1914 | 2096 | 2277 | 2435 | 3090 |
| | | <i>Replacement Upholstery Covers</i> | | | | | | | | | | | | | |
|  | | Overall: 72"w 36"d 28"h | | Arm: n/a | | COM: 6 yds. | | | | | | | | | |
| | | Seat: 72"w 22"/36"d 18"h | | Weight: 137 lbs. | | COL: 108 sq.ft. | | | | | | | | | |
| | | COM | COL | 1 | 2 | 3 | 4 | 5 | 6 | 7 | 8 | 9 | 10 | L1 | L2 |
| | 1562 | 2476 | 2724 | 2673 | 2839 | 3005 | 3171 | 3337 | 3503 | 3669 | 3835 | 4001 | 4167 | 4352 | 4950 |
| | | <i>Tight Seat & Back / Removable Upholstery / 750 lb. Weight Capacity</i> | | | | | | | | | | | | | |
| | 1562-R | 294 | 323 | 641 | 823 | 1005 | 1187 | 1369 | 1550 | 1732 | 1914 | 2096 | 2277 | 2435 | 3090 |
| | | <i>Replacement Upholstery Covers</i> | | | | | | | | | | | | | |
|  | | Overall: 36"w 36"d 19"h | | Arm: n/a | | COM: 2.25 yds. | | | | | | | | | |
| | | Seat: n/a | | Weight: 103 lbs. | | COL: 41 sq.ft. | | | | | | | | | |
| | | COM | COL | 1 | 2 | 3 | 4 | 5 | 6 | 7 | 8 | 9 | 10 | L1 | L2 |
| | 1564-L | 1509 | 1659 | 1542 | 1599 | 1657 | 1715 | 1773 | 1830 | 1888 | 1946 | 2004 | 2061 | 2125 | 2333 |
| | | <i>High Pressure Laminate Face / Multi-Ply Edge</i> | | | | | | | | | | | | | |
| | 1564-R | 135 | 148 | 269 | 341 | 412 | 483 | 554 | 625 | 696 | 767 | 839 | 910 | 975 | 1231 |
| | | <i>Replacement Upholstery Covers</i> | | | | | | | | | | | | | |

DESCRIPTION:

- High Pressure Laminate Face
- Multi-Ply Edge
- Lifetime Warranty

OPTIONS:

Specify Laminate (See Page 6)

| TANDEM | ITEM #: | SPECIFICATIONS GRADES LIST PRICES: | | | | | | | | | | | | | | | | | |
|---|--|---|---|--|--|-----|-----|---|---|---|----|----|----|---|---|---|----|----|----|
| <p>TABLE TOP ONLY / CAN BE SUBSTITUTED FOR ANY BACK</p>  | | <p>Overall: 36"w 14"d 1"h Seat: n/a</p> | <p>Arm: n/a Weight: 16 lbs.</p> | <p>COM: n/a COL: n/a</p> | <table border="1"> <thead> <tr> <th>COM</th> <th>COL</th> <th>1</th> <th>2</th> <th>3</th> <th>4</th> <th>5</th> <th>6</th> <th>7</th> <th>8</th> <th>9</th> <th>10</th> <th>L1</th> <th>L2</th> </tr> </thead> </table> | COM | COL | 1 | 2 | 3 | 4 | 5 | 6 | 7 | 8 | 9 | 10 | L1 | L2 |
| COM | COL | 1 | 2 | 3 | 4 | 5 | 6 | 7 | 8 | 9 | 10 | L1 | L2 | | | | | | |
| | <p>T1-L</p> <p>241 <i>High Pressure Laminate Face / Multi-Ply Edge</i></p> | | | | | | | | | | | | | | | | | | |

Configuration Examples

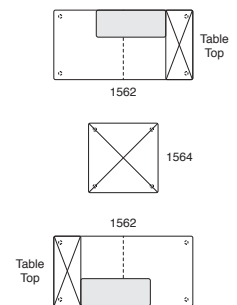
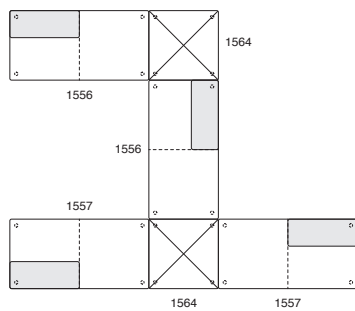
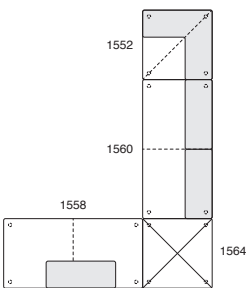
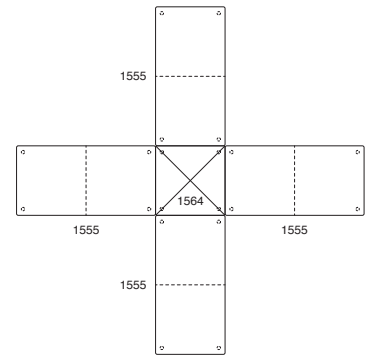
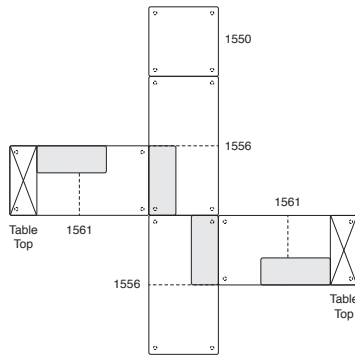
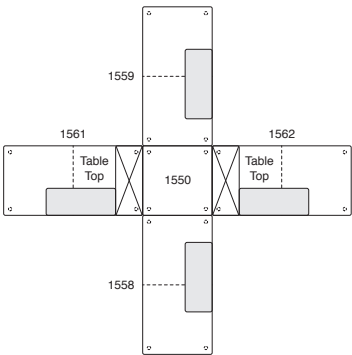
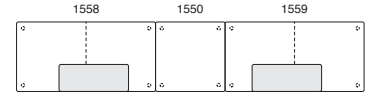
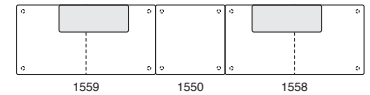
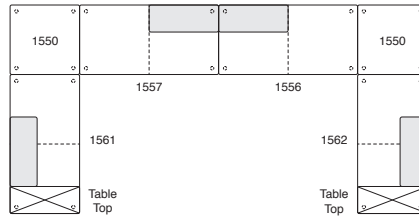
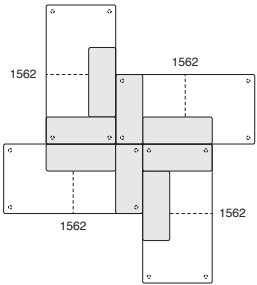
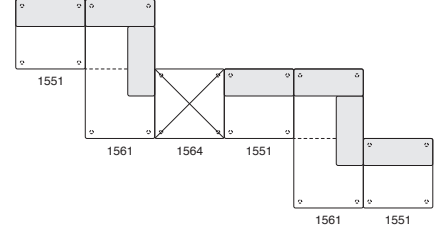
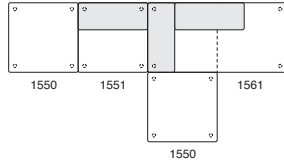
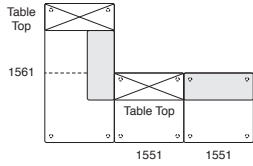

| POWER / COVERS | OPTION #: | SPECIFICATIONS LIST PRICES AVAILABILITY: |
|---|---|--|
| <p>DUAL CHARGING USB</p>  | <p>USB-1</p> <p>\$238 (Per Arm) <i>Spill-Proof Technology / 2 Amps Per Port / Multiple Finish Options / Storm Color Standard (Specify Left or Right Facing)</i></p> <p><i>Available: Facelift Fair & Square Collection</i></p> | |
| <p>POWER MODULE</p>  | <p>PM2</p> <p>\$238 Power Module (1-Power) <i>Spill-Proof Technology / Multiple Finish Options / Storm Color Standard (Specify Left or Right Facing)</i></p> <p><i>Available: Facelift Fair & Square Collection</i></p> | |
| <p>CONTRASTING COVERS</p>  | <p>CC</p> <p>\$129 <i>NOTE: If Two Or More Upholsteries Or Leathers Are Used On Any Piece Of Furniture, Then A Contrast Charge Will Apply Per Order. When Using Trinity Upholstery, The Higher Priced Upholstery Grade Will Be Used In Pricing, Unless It's Trinity Leather With Fabric Contrast Welt, Or COM With Trinity Contrast Welt, Then Contact Customer Service For Pricing.</i></p> <p><i>Available: Facelift Fair & Square Collection</i></p> | |

Facelift Serpentine

LOUNGE / TANDEM / BENCHES / TABLES

Effective: March 1, 2025

T R I N I T Y

Date:

Page:

Modification:

Description:

DESCRIPTION:

- Upholstery Frames: Plywood & Hardwood
- Seat: High Density Polyurethane Foam Over Sheet Webbing
- Back: High Density Polyurethane Foam Over Strap Webbing
- Upholstered Covers: Attached w/ Velcro / Removable For Maintenance
- Antimicrobial Moisture Barrier Fully Encapsulates All Foam Areas
- Ganging Straps Standard
- Brushed Aluminum Round Legs Standard / Removable For Maintenance
- Leather Upholstery Is Not Available
- Lifetime Warranty

OPTIONS:

(See Facelift Serpentine Options Pages)

Feather Down & Polyester Pillows Available (See Page 5)

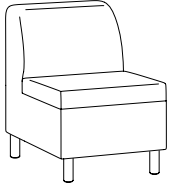
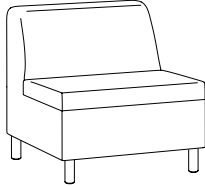
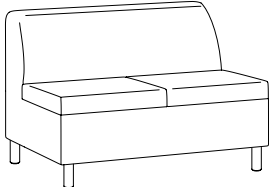
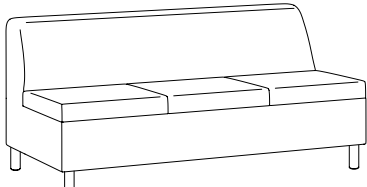
| LOUNGE / TANDEM | ITEM #: | SPECIFICATIONS GRADES LIST PRICES: | | | | | | | | | | | | | | |
|---|--|---|---|--|------|------|------|------|------|------|------|------|------|-----|-----|--|
| <p>STRAIGHT LOUNGE SECTION / FULLY UPHOLSTERED</p>  | | <p>Overall: 22"w 30"d 32"h Seat: 22"w 19.5"d 18"h</p> | <p>Arm: n/a Weight: 45 lbs.</p> | <p>COM: 2.5 yds. COL: n/a</p> | | | | | | | | | | | | |
| | 1571 | COM | COL | 1 | 2 | 3 | 4 | 5 | 6 | 7 | 8 | 9 | 10 | L1 | L2 | |
| | | 1156 | N/A | 1219 | 1282 | 1345 | 1409 | 1472 | 1535 | 1598 | 1661 | 1724 | 1787 | N/A | N/A | |
| | <i>Tight Seat & Back / Removable Upholstery / 500 lb. Weight Capacity</i> | | | | | | | | | | | | | | | |
| 1571-R | 199 | N/A | 337 | 411 | 485 | 559 | 634 | 708 | 782 | 856 | 931 | 1005 | N/A | N/A | | |
| | <i>Replacement Upholstery Covers</i> | | | | | | | | | | | | | | | |
| <p>STRAIGHT BARIATRIC LOUNGE SECTION / FULLY UPHOLSTERED</p>  | | <p>Overall: 30"w 30"d 32"h Seat: 30"w 19.5"d 18"h</p> | <p>Arm: n/a Weight: 65 lbs.</p> | <p>COM: 3 yds. COL: n/a</p> | | | | | | | | | | | | |
| | 1571-X | COM | COL | 1 | 2 | 3 | 4 | 5 | 6 | 7 | 8 | 9 | 10 | L1 | L2 | |
| | | 1263 | N/A | 1348 | 1425 | 1502 | 1580 | 1657 | 1734 | 1811 | 1888 | 1965 | 2042 | N/A | N/A | |
| | <i>Tight Seat & Back / Removable Upholstery / 500 lb. Weight Capacity</i> | | | | | | | | | | | | | | | |
| 1571-XR | 206 | N/A | 376 | 467 | 558 | 649 | 739 | 830 | 921 | 1011 | 1102 | 1193 | N/A | N/A | | |
| | <i>Replacement Upholstery Covers</i> | | | | | | | | | | | | | | | |
| <p>STRAIGHT TWO PLACE LOUNGE SECTION / FULLY UPHOLSTERED</p>  | | <p>Overall: 44"w 30"d 32"h Seat: 44"w 19.5"d 18"h</p> | <p>Arm: n/a Weight: 80 lbs.</p> | <p>COM: 4.25 yds. COL: n/a</p> | | | | | | | | | | | | |
| | 1572 | COM | COL | 1 | 2 | 3 | 4 | 5 | 6 | 7 | 8 | 9 | 10 | L1 | L2 | |
| | | 1783 | N/A | 1910 | 2022 | 2134 | 2246 | 2358 | 2470 | 2583 | 2695 | 2807 | 2919 | N/A | N/A | |
| | <i>Tight Seat & Back / Removable Upholstery / 750 lb. Weight Capacity</i> | | | | | | | | | | | | | | | |
| 1572-R | 218 | N/A | 470 | 602 | 734 | 866 | 998 | 1130 | 1262 | 1394 | 1526 | 1658 | N/A | N/A | | |
| | <i>Replacement Upholstery Covers</i> | | | | | | | | | | | | | | | |
| <p>STRAIGHT THREE PLACE LOUNGE SECTION / FULLY UPHOLSTERED</p>  | | <p>Overall: 66"w 30"d 32"h Seat: 66"w 19.5"d 18"h</p> | <p>Arm: n/a Weight: 95 lbs.</p> | <p>COM: 5.5 yds. COL: n/a</p> | | | | | | | | | | | | |
| | 1573 | COM | COL | 1 | 2 | 3 | 4 | 5 | 6 | 7 | 8 | 9 | 10 | L1 | L2 | |
| | | 2441 | N/A | 2603 | 2750 | 2897 | 3044 | 3192 | 3339 | 3486 | 3633 | 3780 | 3928 | N/A | N/A | |
| | <i>Tight Seat & Back / Removable Upholstery / 1000 lb. Weight Capacity</i> | | | | | | | | | | | | | | | |
| 1573-R | 286 | N/A | 617 | 790 | 963 | 1136 | 1309 | 1483 | 1656 | 1829 | 2002 | 2175 | N/A | N/A | | |
| | <i>Replacement Upholstery Covers</i> | | | | | | | | | | | | | | | |

DESCRIPTION:

- Upholstery Frames: Plywood & Hardwood
- Seat: High Density Polyurethane Foam Over Sheet Webbing
- Back: High Density Polyurethane Foam Over Strap Webbing
- Upholstered Covers: Attached w/ Velcro / Removable For Maintenance
- Antimicrobial Moisture Barrier Fully Encapsulates All Foam Areas
- Ganging Straps Standard
- Brushed Aluminum Round Legs Standard / Removable For Maintenance
- Leather Upholstery Is Not Available
- Lifetime Warranty

OPTIONS:

(See Facelift Serpentine Options Pages)

Feather Down & Polyester Pillows Available (See Page 5)

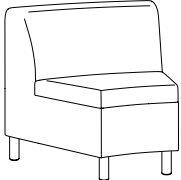
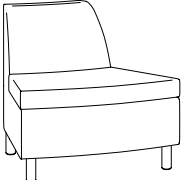
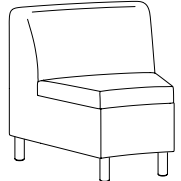
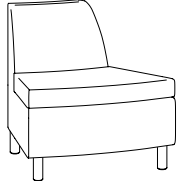
| TANDEM | ITEM #: | SPECIFICATIONS GRADES LIST PRICES: | | | | | | | | | | | | | |
|---|---------|--|------------|------------------------|----------|-----------------------|----------|----------|----------|----------|----------|----------|-----------|-----------|-----------|
|  | | Overall: 34"w 30"d 32"h | | Arm: n/a | | COM: 3.25 yds. | | | | | | | | | |
| | | Seat: 28"w 19.5"d 18"h | | Weight: 50 lbs. | | COL: n/a | | | | | | | | | |
| | | COM | COL | 1 | 2 | 3 | 4 | 5 | 6 | 7 | 8 | 9 | 10 | L1 | L2 |
| | 1574 | 1393 | N/A | 1486 | 1570 | 1654 | 1738 | 1822 | 1906 | 1990 | 2075 | 2159 | 2243 | N/A | N/A |
| | | <i>Tight Seat & Back / 60" Radius / Removable Upholstery / 500 lb. Weight Capacity</i> | | | | | | | | | | | | | |
| | 1574-R | 221 | N/A | 407 | 506 | 605 | 704 | 803 | 902 | 803 | 877 | 951 | 1025 | N/A | N/A |
| | | <i>Replacement Upholstery Covers</i> | | | | | | | | | | | | | |
|  | | Overall: 34"w 30"d 32"h | | Arm: n/a | | COM: 3.25 yds. | | | | | | | | | |
| | | Seat: 34"w 19.5"d 18"h | | Weight: 45 lbs. | | COL: n/a | | | | | | | | | |
| | | COM | COL | 1 | 2 | 3 | 4 | 5 | 6 | 7 | 8 | 9 | 10 | L1 | L2 |
| | 1575 | 1319 | N/A | 1415 | 1499 | 1583 | 1667 | 1752 | 1836 | 1920 | 2004 | 2088 | 2172 | N/A | N/A |
| | | <i>Tight Seat & Back / 60" Radius / Removable Upholstery / 500 lb. Weight Capacity</i> | | | | | | | | | | | | | |
| | 1575-R | 203 | N/A | 390 | 489 | 588 | 687 | 786 | 885 | 983 | 1082 | 1181 | 1280 | N/A | N/A |
| | | <i>Replacement Upholstery Covers</i> | | | | | | | | | | | | | |
|  | | Overall: 32"w 30"d 32"h | | Arm: n/a | | COM: 2.75 yds. | | | | | | | | | |
| | | Seat: 25.5"w 19.5"d 18"h | | Weight: 50 lbs. | | COL: n/a | | | | | | | | | |
| | | COM | COL | 1 | 2 | 3 | 4 | 5 | 6 | 7 | 8 | 9 | 10 | L1 | L2 |
| | 1576 | 1269 | N/A | 1340 | 1410 | 1480 | 1550 | 1620 | 1690 | 1761 | 1831 | 1901 | 1971 | N/A | N/A |
| | | <i>Tight Seat & Back / 30" Radius / Removable Upholstery / 500 lb. Weight Capacity</i> | | | | | | | | | | | | | |
| | 1576-R | 214 | N/A | 367 | 450 | 532 | 615 | 697 | 780 | 862 | 944 | 1027 | 1109 | N/A | N/A |
| | | <i>Replacement Upholstery Covers</i> | | | | | | | | | | | | | |
|  | | Overall: 32"w 30"d 32"h | | Arm: n/a | | COM: 2.75 yds. | | | | | | | | | |
| | | Seat: 32"w 19.5"d 18"h | | Weight: 45 lbs. | | COL: n/a | | | | | | | | | |
| | | COM | COL | 1 | 2 | 3 | 4 | 5 | 6 | 7 | 8 | 9 | 10 | L1 | L2 |
| | 1577 | 1236 | N/A | 1309 | 1379 | 1449 | 1519 | 1589 | 1659 | 1729 | 1799 | 1869 | 1939 | N/A | N/A |
| | | <i>Tight Seat & Back / 30" Radius / Removable Upholstery / 500 lb. Weight Capacity</i> | | | | | | | | | | | | | |
| | 1577-R | 196 | N/A | 350 | 433 | 515 | 598 | 680 | 762 | 1571 | 1744 | 1917 | 2090 | N/A | N/A |
| | | <i>Replacement Upholstery Covers</i> | | | | | | | | | | | | | |

DESCRIPTION:

- Upholstery Frames: Plywood & Hardwood
- Seat: High Density Polyurethane Foam Over Sheet Webbing
- Back: High Density Polyurethane Foam Over Strap Webbing
- Upholstered Covers: Attached w/ Velcro / Removable For Maintenance
- Antimicrobial Moisture Barrier Fully Encapsulates All Foam Areas
- Ganging Straps Standard
- Brushed Aluminum Round Legs Standard / Removable For Maintenance
- Leather Upholstery Is Not Available
- Lifetime Warranty

OPTIONS:

(See Facelift Serpentine Options Pages)

Feather Down & Polyester Pillows Available (See Page 5)

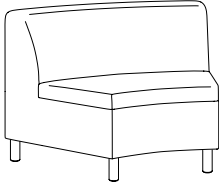
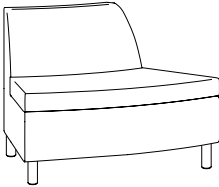
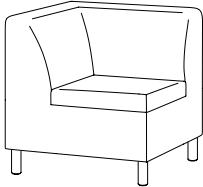
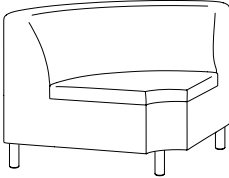
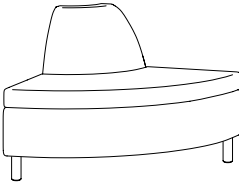
| TANDEM | | ITEM #: | SPECIFICATIONS GRADES LIST PRICES: | | | | | | | | | | | | | |
|---|--|--|---|------------|----------|---|----------|----------|--|----------|----------|----------|----------|-----------|-----------|-----------|
|  | 45° INSIDE WEDGE / FULLY UPHOLSTERED | | Overall: 46.5"w 30"d 32"h Seat: 37.5"w 19.5"d 18"h | | | Arm: n/a Weight: 50 lbs. | | | COM: 3.5 yds. COL: n/a | | | | | | | |
| | | | COM | COL | 1 | 2 | 3 | 4 | 5 | 6 | 7 | 8 | 9 | 10 | L1 | L2 |
| | 1578 | | 1730 | N/A | 1817 | 1909 | 2000 | 2091 | 2182 | 2273 | 2364 | 2455 | 2546 | 2638 | N/A | N/A |
| | | <i>Tight Seat & Back / 30" Radius / Removable Upholstery / 500 lb. Weight Capacity</i> | | | | | | | | | | | | | | |
| | 1578-R | 250 | N/A | 450 | 558 | 665 | 772 | 879 | 986 | 1094 | 1201 | 1308 | 1415 | N/A | N/A | |
| | | <i>Replacement Upholstery Covers</i> | | | | | | | | | | | | | | |
|  | 45° OUTSIDE WEDGE / FULLY UPHOLSTERED | | Overall: 46.5"w 30"d 32"h Seat: 46.5"w 19.5"d 18"h | | | Arm: n/a Weight: 50 lbs. | | | COM: 3.25 yds. COL: n/a | | | | | | | |
| | | | COM | COL | 1 | 2 | 3 | 4 | 5 | 6 | 7 | 8 | 9 | 10 | L1 | L2 |
| | 1579 | | 1664 | N/A | 1742 | 1826 | 1910 | 1994 | 2078 | 2162 | 2246 | 2331 | 2415 | 2499 | N/A | N/A |
| | | <i>Tight Seat & Back / 30" Radius / Removable Upholstery / 500 lb. Weight Capacity</i> | | | | | | | | | | | | | | |
| | 1579-R | 250 | N/A | 434 | 533 | 632 | 731 | 830 | 929 | 1028 | 1127 | 1226 | 1325 | N/A | N/A | |
| | | <i>Replacement Upholstery Covers</i> | | | | | | | | | | | | | | |
|  | 90° CORNER UNIT / FULLY UPHOLSTERED | | Overall: 30"w 30"d 32"h Seat: 19.5"w 19.5"d 18"h | | | Arm: n/a Weight: 80 lbs. | | | COM: 3.5 yds. COL: n/a | | | | | | | |
| | | | COM | COL | 1 | 2 | 3 | 4 | 5 | 6 | 7 | 8 | 9 | 10 | L1 | L2 |
| | 1580 | | 1734 | N/A | 1766 | 1829 | 1892 | 1955 | 2018 | 2081 | 2144 | 2207 | 2270 | 2333 | N/A | N/A |
| | | <i>Tight Seat & Back / Removable Upholstery / 500 lb. Weight Capacity</i> | | | | | | | | | | | | | | |
| | 1580-R | 283 | N/A | 531 | 663 | 795 | 927 | 1059 | 1191 | 861 | 935 | 1010 | 1084 | N/A | N/A | |
| | | <i>Replacement Upholstery Covers</i> | | | | | | | | | | | | | | |
|  | 90° INSIDE WEDGE / FULLY UPHOLSTERED | | Overall: 51"w 33"d 32"h Seat: 37.5"w 19.5"d 18"h | | | Arm: n/a Weight: 70 lbs. | | | COM: 4 yds. COL: n/a | | | | | | | |
| | | | COM | COL | 1 | 2 | 3 | 4 | 5 | 6 | 7 | 8 | 9 | 10 | L1 | L2 |
| | 1581 | | 2006 | N/A | 2107 | 2212 | 2318 | 2423 | 2528 | 2633 | 2738 | 2843 | 2949 | 3054 | N/A | N/A |
| | | <i>Tight Seat & Back / 6" Radius / Removable Upholstery / 500 lb. Weight Capacity</i> | | | | | | | | | | | | | | |
| | 1581-R | 268 | N/A | 418 | 500 | 583 | 665 | 748 | 830 | 913 | 995 | 1078 | 1160 | N/A | N/A | |
| | | <i>Replacement Upholstery Covers</i> | | | | | | | | | | | | | | |
|  | 90° OUTSIDE WEDGE / FULLY UPHOLSTERED | | Overall: 51"w 33"d 32"h Seat: 51"w 19.5"d 18"h | | | Arm: n/a Weight: 70 lbs. | | | COM: 4 yds. COL: n/a | | | | | | | |
| | | | COM | COL | 1 | 2 | 3 | 4 | 5 | 6 | 7 | 8 | 9 | 10 | L1 | L2 |
| | 1582 | | 1806 | N/A | 1917 | 2022 | 2128 | 2233 | 2338 | 2443 | 2548 | 2653 | 2759 | 2864 | N/A | N/A |
| | | <i>Tight Seat & Back / 6" Radius / Removable Upholstery / 500 lb. Weight Capacity</i> | | | | | | | | | | | | | | |
| | 1582-R | 256 | N/A | 457 | 564 | 671 | 778 | 885 | 993 | 1100 | 1207 | 1314 | 1421 | N/A | N/A | |
| | | <i>Replacement Upholstery Covers</i> | | | | | | | | | | | | | | |

DESCRIPTION:

- Upholstery Frames: Plywood & Hardwood
- Seat: High Density Polyurethane Foam Over Sheet Webbing
- Upholstered Covers: Attached w/ Velcro / Removable For Maintenance
- Antimicrobial Moisture Barrier Fully Encapsulates All Foam Areas
- Ganging Straps Standard
- Brushed Aluminum Round Legs Standard / Removable For Maintenance
- Leather Upholstery Is Not Available
- Lifetime Warranty

OPTIONS:

(See Facelift Serpentine Options Pages)

Feather Down & Polyester Pillows Available (See Page 5)

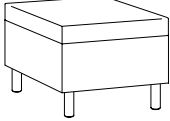
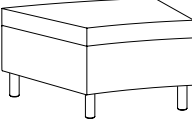
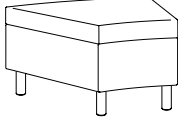
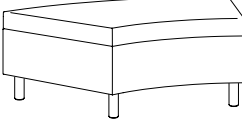
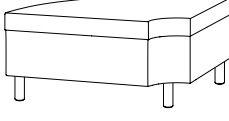
| BENCHES | | ITEM #: | SPECIFICATIONS GRADES LIST PRICES: | | | | | | | | | | | | | |
|---|-------------|---------------|--|------------|----------|---|----------|----------|--|----------|----------|----------|----------|-----------|-----------|-----------|
|  | | | Overall: 30"w 22"d 18"h Seat: 30"w 22"d 18"h | | | Arm: n/a Weight: 20 lbs. | | | COM: 2 yds. COL: n/a | | | | | | | |
| | | | COM | COL | 1 | 2 | 3 | 4 | 5 | 6 | 7 | 8 | 9 | 10 | L1 | L2 |
| | 1587 | | 813 | N/A | 867 | 916 | 965 | 1014 | 1063 | 1112 | 1161 | 1210 | 1259 | 1308 | N/A | N/A |
| | | | Tight Seat / Removable Upholstery / 500 lb. Weight Capacity | | | | | | | | | | | | | |
| | | 1587-R | 142 | N/A | 250 | 307 | 365 | 423 | 481 | 538 | 596 | 654 | 711 | 769 | N/A | N/A |
| | | | Replacement Upholstery Covers | | | | | | | | | | | | | |
|  | | | Overall: 34"w 30"d 18"h Seat: 34"w 19.5"d 18"h | | | Arm: n/a Weight: 40 lbs. | | | COM: 2.25 yds. COL: n/a | | | | | | | |
| | | | COM | COL | 1 | 2 | 3 | 4 | 5 | 6 | 7 | 8 | 9 | 10 | L1 | L2 |
| | 1588 | | 994 | N/A | 1052 | 1108 | 1164 | 1220 | 1277 | 1333 | 1389 | 1445 | 1501 | 1557 | N/A | N/A |
| | | | Tight Seat / 60" Radius / Removable Upholstery / 500 lb. Weight Capacity | | | | | | | | | | | | | |
| | | 1588-R | 157 | N/A | 280 | 346 | 412 | 478 | 544 | 610 | 676 | 742 | 808 | 874 | N/A | N/A |
| | | | Replacement Upholstery Covers | | | | | | | | | | | | | |
|  | | | Overall: 32"w 30"d 18"h Seat: 32"w 19.5"d 18"h | | | Arm: n/a Weight: 40 lbs. | | | COM: 1.75 yds. COL: n/a | | | | | | | |
| | | | COM | COL | 1 | 2 | 3 | 4 | 5 | 6 | 7 | 8 | 9 | 10 | L1 | L2 |
| | 1589 | | 943 | N/A | 976 | 1018 | 1060 | 1102 | 1144 | 1186 | 1228 | 1270 | 1313 | 1355 | N/A | N/A |
| | | | Tight Seat / 30" Radius / Removable Upholstery / 500 lb. Weight Capacity | | | | | | | | | | | | | |
| | | 1589-R | 139 | N/A | 230 | 280 | 329 | 379 | 428 | 478 | 527 | 577 | 626 | 676 | N/A | N/A |
| | | | Replacement Upholstery Covers | | | | | | | | | | | | | |
|  | | | Overall: 46.5"w 30"d 18"h Seat: 46.5"w 19.5"d 18"h | | | Arm: n/a Weight: 45 lbs. | | | COM: 2.5 yds. COL: n/a | | | | | | | |
| | | | COM | COL | 1 | 2 | 3 | 4 | 5 | 6 | 7 | 8 | 9 | 10 | L1 | L2 |
| | 1590 | | 1322 | N/A | 1376 | 1439 | 1502 | 1565 | 1628 | 1691 | 1754 | 1818 | 1881 | 1944 | N/A | N/A |
| | | | Tight Seat / 30" Radius / Removable Upholstery / 500 lb. Weight Capacity | | | | | | | | | | | | | |
| | | 1590-R | 179 | N/A | 317 | 392 | 466 | 540 | 614 | 689 | 763 | 837 | 911 | 985 | N/A | N/A |
| | | | Replacement Upholstery Covers | | | | | | | | | | | | | |
|  | | | Overall: 51"w 33"d 18"h Seat: 51"w 19.5"d 18"h | | | Arm: n/a Weight: 50 lbs. | | | COM: 2.75 yds. COL: n/a | | | | | | | |
| | | | COM | COL | 1 | 2 | 3 | 4 | 5 | 6 | 7 | 8 | 9 | 10 | L1 | L2 |
| | 1591 | | 1441 | N/A | 1503 | 1573 | 1643 | 1713 | 1783 | 1853 | 1923 | 1993 | 2064 | 2134 | N/A | N/A |
| | | | Tight Seat / 6" Radius / Removable Upholstery / 500 lb. Weight Capacity | | | | | | | | | | | | | |
| | | 1591-R | 221 | N/A | 374 | 457 | 539 | 622 | 704 | 787 | 869 | 952 | 1034 | 1116 | N/A | N/A |
| | | | Replacement Upholstery Covers | | | | | | | | | | | | | |

DESCRIPTION:

- Upholstery Frames: Plywood & Hardwood
- Seat: High Density Polyurethane Foam Over Sheet Webbing
- Upholstered Covers: Attached w/ Velcro / Removable For Maintenance
- Antimicrobial Moisture Barrier Fully Encapsulates All Foam Areas
- Ganging Straps Standard
- Brushed Aluminum Round Legs Standard / Removable For Maintenance
- Leather Upholstery Is Not Available
- Lifetime Warranty

OPTIONS:

(See Facelift Serpentine Options Pages)

Feather Down & Polyester Pillows Available (See Page 5)

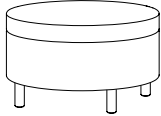
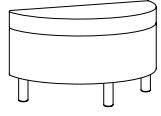
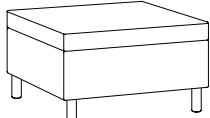
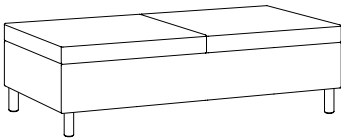
| BENCHES | | ITEM #: | SPECIFICATIONS GRADES LIST PRICES: | | | | | | | | | | | | |
|--|---------------|---|--|------------|----------|------------------------|----------|----------|-----------------------|----------|----------|----------|----------|-----------|-----------|
| ROUND BENCH / FULLY UPHOLSTERED  | | | Overall: 30" Diameter 18"h | | | Arm: n/a | | | COM: 2.5 yds. | | | | | | |
| | | | Seat: 30"w 30"d 18"h | | | Weight: 30 lbs. | | | COL: n/a | | | | | | |
| | | | COM | COL | 1 | 2 | 3 | 4 | 5 | 6 | 7 | 8 | 9 | 10 | L1 |
| | 1592 | 1106 | N/A | 1171 | 1235 | 1298 | 1361 | 1424 | 1487 | 1550 | 1613 | 1676 | 1739 | N/A | N/A |
| | | <i>Tight Seat / Removable Upholstery / 500 lb. Weight Capacity</i> | | | | | | | | | | | | | |
| | 1592-R | 142 | N/A | 283 | 357 | 431 | 506 | 580 | 654 | 728 | 802 | 877 | 951 | N/A | N/A |
| | | <i>Replacement Upholstery Covers</i> | | | | | | | | | | | | | |
| HALF-ROUND BENCH / FULLY UPHOLSTERED  | | | Overall: 30"w 15"d 18"h | | | Arm: n/a | | | COM: 1.75 yds. | | | | | | |
| | | | Seat: 30"w 15"d 18"h | | | Weight: 20 lbs. | | | COL: n/a | | | | | | |
| | | | COM | COL | 1 | 2 | 3 | 4 | 5 | 6 | 7 | 8 | 9 | 10 | L1 |
| | 1593 | 881 | N/A | 917 | 959 | 1001 | 1043 | 1085 | 1127 | 1169 | 1211 | 1253 | 1295 | N/A | N/A |
| | | <i>Tight Seat / 60" Radius / Removable Upholstery / 500 lb. Weight Capacity</i> | | | | | | | | | | | | | |
| | 1593-R | 139 | N/A | 230 | 280 | 329 | 378 | 428 | 477 | 527 | 576 | 626 | 675 | N/A | N/A |
| | | <i>Replacement Upholstery Covers</i> | | | | | | | | | | | | | |
| FREESTANDING BENCH / FULLY UPHOLSTERED  | | | Overall: 30"w 30"d 18"h | | | Arm: n/a | | | COM: 1.5 yds. | | | | | | |
| | | | Seat: 30"w 30"d 18"h | | | Weight: 30 lbs. | | | COL: n/a | | | | | | |
| | | | COM | COL | 1 | 2 | 3 | 4 | 5 | 6 | 7 | 8 | 9 | 10 | L1 |
| | 1594 | 1023 | N/A | 1220 | 1346 | 1472 | 1598 | 1724 | 1850 | 1977 | 2103 | 2229 | 2355 | N/A | N/A |
| | | <i>Tight Seat / Removable Upholstery / 500 lb. Weight Capacity</i> | | | | | | | | | | | | | |
| | 1594-R | 142 | N/A | 216 | 258 | 299 | 340 | 381 | 422 | 464 | 505 | 546 | 587 | N/A | N/A |
| | | <i>Replacement Upholstery Covers</i> | | | | | | | | | | | | | |
| FREESTANDING BENCH / FULLY UPHOLSTERED  | | | Overall: 60"w 30"d 18"h | | | Arm: n/a | | | COM: 5.25 yds. | | | | | | |
| | | | Seat: 60"w 30"d 18"h | | | Weight: 60 lbs. | | | COL: n/a | | | | | | |
| | | | COM | COL | 1 | 2 | 3 | 4 | 5 | 6 | 7 | 8 | 9 | 10 | L1 |
| | 1595 | 1761 | N/A | 1946 | 2086 | 2226 | 2366 | 2506 | 2647 | 2787 | 2927 | 3067 | 3207 | N/A | N/A |
| | | <i>Tight Seat / Removable Upholstery / 750 lb. Weight Capacity</i> | | | | | | | | | | | | | |
| | 1595-R | 199 | N/A | 518 | 683 | 848 | 1013 | 1177 | 1342 | 1507 | 1672 | 1837 | 2002 | N/A | N/A |
| | | <i>Replacement Upholstery Covers</i> | | | | | | | | | | | | | |

DESCRIPTION:

- Upholstery Frames: Plywood & Hardwood
- Upholstered Covers: Attached w/ Velcro / Removable For Maintenance
- Antimicrobial Moisture Barrier Fully Encapsulates All Foam Areas
- Ganging Straps Standard
- Brushed Aluminum Round Legs Standard / Removable For Maintenance
- High Pressure Laminate Top - Self Edge
- Leather Upholstery Is Not Available
- Lifetime Warranty

OPTIONS:

(See Facelift Serpentine Options Pages)

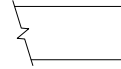

Square Edge Profile Standard

TABLES

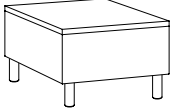
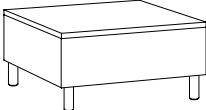
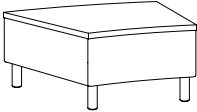
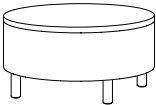
| ITEM #: | SPECIFICATIONS GRADES LIST PRICES: | | | | | | | | | | | | | |
|---|--|------------|----------|------------------------|----------|----------|----------|----------|-----------------------|----------|----------|-----------|-----------|-----------|
| STRAIGHT TABLE / FREESTANDING OR CONNECTING  | Overall: 30"w 22"d 16"h | | | Arm: n/a | | | | | COM: 1.25 yds. | | | | | |
| | Seat: n/a | | | Weight: 55 lbs. | | | | | COL: n/a | | | | | |
| | COM | COL | 1 | 2 | 3 | 4 | 5 | 6 | 7 | 8 | 9 | 10 | L1 | L2 |
| | 152230-L | 1057 | N/A | 1075 | 1104 | 1132 | 1161 | 1189 | 1218 | 1246 | 1275 | 1304 | 1332 | N/A |
| 152230-C | 1544 | N/A | 1552 | 1581 | 1610 | 1638 | 1667 | 1696 | 1724 | 1753 | 1782 | 1811 | N/A | N/A |
| 152230-R | 120 | N/A | 179 | 212 | 245 | 278 | 311 | 344 | 377 | 410 | 443 | 476 | N/A | N/A |
| <i>High Pressure Laminate Face</i> <i>Solid Surface Face (Glacier White)</i> <i>Replacement Upholstery Covers</i> | | | | | | | | | | | | | | |
| STRAIGHT TABLE / FREESTANDING OR CONNECTING  | Overall: 30"w 30"d 16"h | | | Arm: n/a | | | | | COM: 1.25 yds. | | | | | |
| | Seat: n/a | | | Weight: 60 lbs. | | | | | COL: n/a | | | | | |
| | COM | COL | 1 | 2 | 3 | 4 | 5 | 6 | 7 | 8 | 9 | 10 | L1 | L2 |
| | 153030-L | 1149 | N/A | 1164 | 1192 | 1221 | 1249 | 1278 | 1307 | 1335 | 1364 | 1392 | 1421 | N/A |
| 153030-C | 1956 | N/A | 1959 | 1988 | 2016 | 2045 | 2074 | 2103 | 2132 | 2160 | 2189 | 2218 | N/A | N/A |
| 153030-R | 133 | N/A | 191 | 224 | 257 | 290 | 323 | 356 | 389 | 422 | 455 | 488 | N/A | N/A |
| <i>High Pressure Laminate Face</i> <i>Solid Surface Face (Glacier White)</i> <i>Replacement Upholstery Covers</i> | | | | | | | | | | | | | | |
| 22.5° TABLE WEDGE / FREESTANDING OR CONNECTING  | Overall: 34"w 30"d 16"h | | | Arm: n/a | | | | | COM: 1.25 yds. | | | | | |
| | Seat: n/a | | | Weight: 65 lbs. | | | | | COL: n/a | | | | | |
| | COM | COL | 1 | 2 | 3 | 4 | 5 | 6 | 7 | 8 | 9 | 10 | L1 | L2 |
| | 1522DG60-L | 1436 | N/A | 1440 | 1469 | 1497 | 1526 | 1554 | 1583 | 1611 | 1640 | 1668 | 1697 | N/A |
| 1522DG60-C | 2284 | N/A | 2291 | 2320 | 2349 | 2378 | 2407 | 2436 | 2465 | 2494 | 2523 | 2552 | N/A | N/A |
| 1522DG60-R | 140 | N/A | 199 | 232 | 265 | 298 | 331 | 364 | 397 | 430 | 463 | 496 | N/A | N/A |
| <i>High Pressure Laminate Face / 60" Radius</i> <i>Solid Surface Face (Glacier White) / 60" Radius</i> <i>Replacement Upholstery Covers</i> | | | | | | | | | | | | | | |
| ROUND COFFEE TABLE / FREESTANDING  | Overall: 30" Diameter 16"h | | | Arm: n/a | | | | | COM: 1.25 yds. | | | | | |
| | Seat: 18"h | | | Weight: 55 lbs. | | | | | COL: n/a | | | | | |
| | COM | COL | 1 | 2 | 3 | 4 | 5 | 6 | 7 | 8 | 9 | 10 | L1 | L2 |
| | 1530D16-L | 1255 | N/A | 1266 | 1294 | 1323 | 1351 | 1380 | 1408 | 1437 | 1465 | 1494 | 1523 | N/A |
| 1530D16-C | 2186 | N/A | 2191 | 2220 | 2249 | 2277 | 2306 | 2335 | 2364 | 2393 | 2422 | 2451 | N/A | N/A |
| 1530D16-R | 141 | N/A | 199 | 232 | 265 | 298 | 331 | 364 | 397 | 430 | 463 | 496 | N/A | N/A |
| <i>High Pressure Laminate Face / Round</i> <i>Solid Surface Face (Glacier White) / Round</i> <i>Replacement Upholstery Covers</i> | | | | | | | | | | | | | | |

DESCRIPTION:

- Upholstery Frames: Plywood & Hardwood
- Upholstered Covers: Attached w/ Velcro / Removable For Maintenance
- Antimicrobial Moisture Barrier Fully Encapsulates All Foam Areas
- Ganging Straps Standard
- Brushed Aluminum Round Legs Standard / Removable For Maintenance
- High Pressure Laminate Top - Self Edge
- Leather Upholstery Is Not Available
- Lifetime Warranty

OPTIONS:

(See Facelift Serpentine Options Pages)

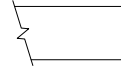

Square Edge Profile Standard

TABLES

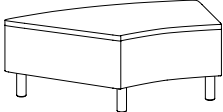
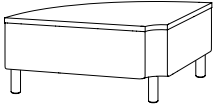
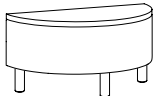

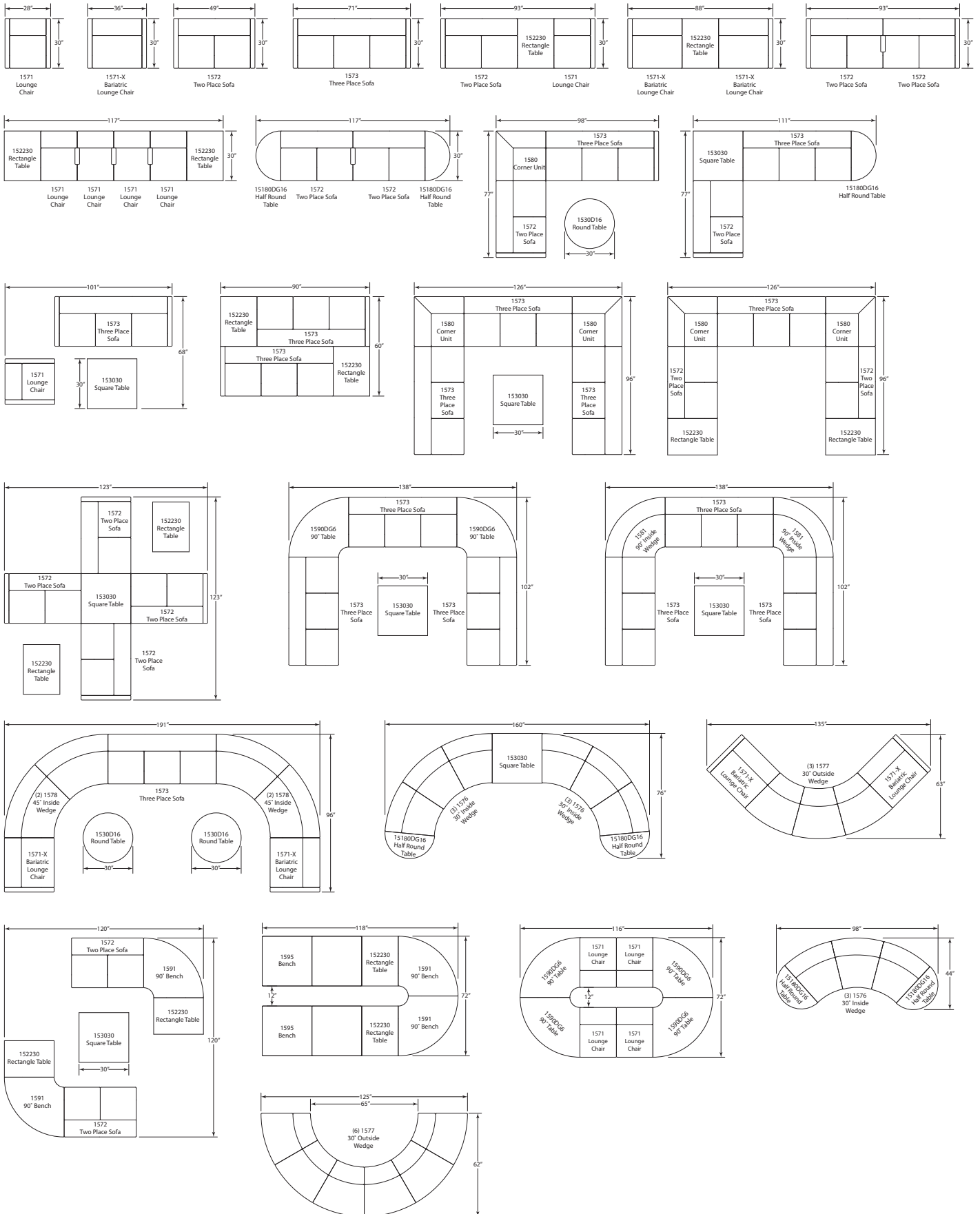

| ITEM #: | | SPECIFICATIONS GRADES LIST PRICES: | | | | | | | | | | | | | |
|--|--------------------|--|------------|----------|-------------------------|----------|----------|-----------------------|----------|----------|----------|----------|-----------|-----------|-----------|
| <p>STRAIGHT TABLE / FREESTANDING OR CONNECTING</p>  | | Overall: 32"w 30"d 16"h | | | Arm: n/a | | | COM: 1.25 yds. | | | | | | | |
| | | Seat: n/a | | | Weight: 60 lbs. | | | COL: n/a | | | | | | | |
| | | COM | COL | 1 | 2 | 3 | 4 | 5 | 6 | 7 | 8 | 9 | 10 | L1 | L2 |
| | 1530DG30-L | 1281 | N/A | 1291 | 1319 | 1348 | 1376 | 1405 | 1433 | 1462 | 1491 | 1519 | 1548 | N/A | N/A |
| | | <i>High Pressure Laminate Face / 30" Radius</i> | | | | | | | | | | | | | |
| | 1530DG30-C | 2266 | N/A | 2268 | 2297 | 2326 | 2355 | 2384 | 2413 | 2442 | 2471 | 2500 | 2529 | N/A | N/A |
| | | <i>Solid Surface Face (Glacier White) / 30" Radius</i> | | | | | | | | | | | | | |
| | 1530DG30-R | 128 | N/A | 187 | 220 | 253 | 286 | 319 | 352 | 385 | 418 | 451 | 484 | N/A | N/A |
| | | <i>Replacement Upholstery Covers</i> | | | | | | | | | | | | | |
| <p>STRAIGHT TABLE / FREESTANDING OR CONNECTING</p>  | | Overall: 46.5"w 30"d 16"h | | | Arm: n/a | | | COM: 1.25 yds. | | | | | | | |
| | | Seat: n/a | | | Weight: 95 lbs. | | | COL: n/a | | | | | | | |
| | | COM | COL | 1 | 2 | 3 | 4 | 5 | 6 | 7 | 8 | 9 | 10 | L1 | L2 |
| | 1545DG30-L | 1832 | N/A | 1835 | 1864 | 1893 | 1921 | 1950 | 1979 | 2008 | 2036 | 2065 | 2094 | N/A | N/A |
| | | <i>High Pressure Laminate Face / 30" Radius</i> | | | | | | | | | | | | | |
| | 1545DG30-C | 3647 | N/A | 3650 | 3679 | 3709 | 3738 | 3767 | 3796 | 3826 | 3855 | 3884 | 3913 | N/A | N/A |
| | | <i>Solid Surface Face (Glacier White) / 30" Radius</i> | | | | | | | | | | | | | |
| | 1545DG30-R | 186 | N/A | 241 | 274 | 307 | 340 | 373 | 406 | 439 | 472 | 505 | 538 | N/A | N/A |
| | | <i>Replacement Upholstery Covers</i> | | | | | | | | | | | | | |
| <p>22.5° TABLE WEDGE / FREESTANDING OR CONNECTING</p>  | | Overall: 51"w 32"d 16"h | | | Arm: n/a | | | COM: 2 yds. | | | | | | | |
| | | Seat: n/a | | | Weight: 110 lbs. | | | COL: n/a | | | | | | | |
| | | COM | COL | 1 | 2 | 3 | 4 | 5 | 6 | 7 | 8 | 9 | 10 | L1 | L2 |
| | 1590DG6-L | 1825 | N/A | 1833 | 1883 | 1932 | 1981 | 2031 | 2080 | 2129 | 2179 | 2228 | 2277 | N/A | N/A |
| | | <i>High Pressure Laminate Face / 6" Radius</i> | | | | | | | | | | | | | |
| | 1590DG6-C | 3254 | N/A | 3258 | 3308 | 3358 | 3409 | 3459 | 3510 | 3560 | 3610 | 3661 | 3711 | N/A | N/A |
| | | <i>Solid Surface Face (Glacier White) / 6" Radius</i> | | | | | | | | | | | | | |
| | 1590DG6-R | 208 | N/A | 312 | 370 | 428 | 485 | 543 | 601 | 659 | 716 | 774 | 832 | N/A | N/A |
| | | <i>Replacement Upholstery Covers</i> | | | | | | | | | | | | | |
| <p>HALF ROUND COFFEE TABLE / FREESTANDING</p>  | | Overall: 30"w 15"d 16"h | | | Arm: n/a | | | COM: 1 yd. | | | | | | | |
| | | Seat: n/a | | | Weight: 40 lbs. | | | COL: n/a | | | | | | | |
| | | COM | COL | 1 | 2 | 3 | 4 | 5 | 6 | 7 | 8 | 9 | 10 | L1 | L2 |
| | 15180DG16-L | 1113 | N/A | 1114 | 1136 | 1157 | 1178 | 1200 | 1221 | 1243 | 1264 | 1286 | 1307 | N/A | N/A |
| | | <i>High Pressure Laminate Face</i> | | | | | | | | | | | | | |
| | 15180DG16-C | 1510 | N/A | 1511 | 1532 | 1554 | 1576 | 1597 | 1619 | 1641 | 1662 | 1684 | 1705 | N/A | N/A |
| | | <i>Solid Surface Face (Glacier White)</i> | | | | | | | | | | | | | |
| | 15180DG16-R | 127 | N/A | 219 | 268 | 318 | 367 | 417 | 466 | 516 | 565 | 615 | 664 | N/A | N/A |
| | | <i>Replacement Upholstery Covers</i> | | | | | | | | | | | | | |

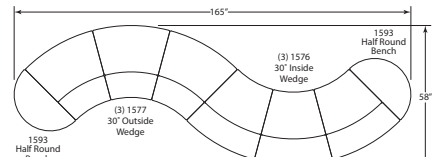
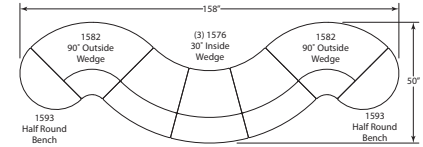
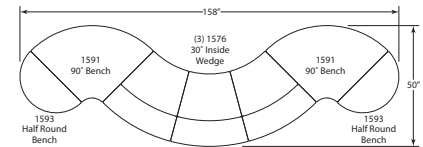
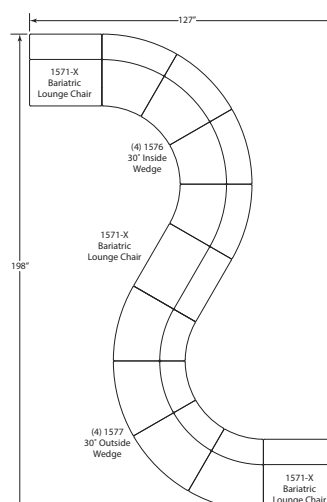
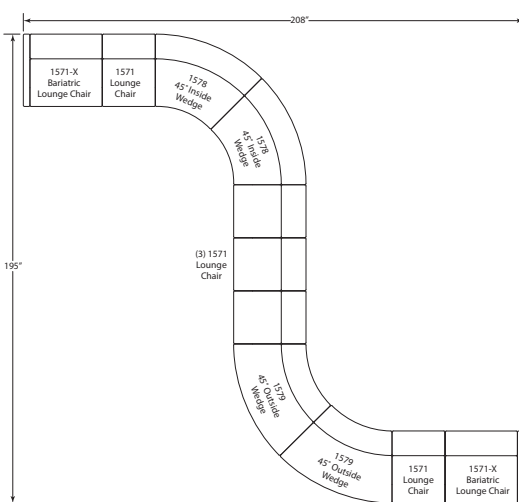
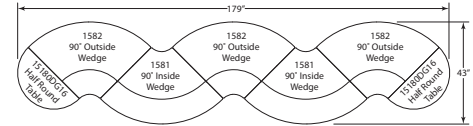
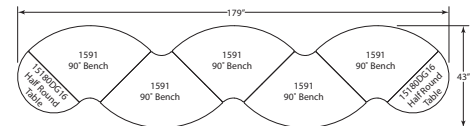
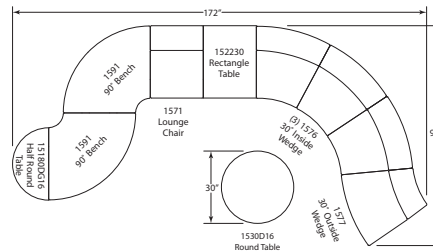
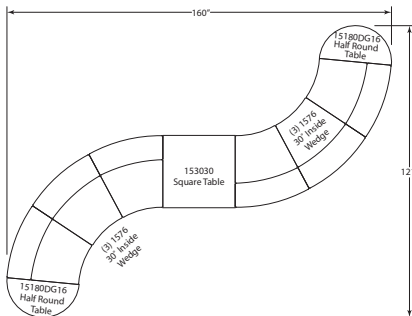
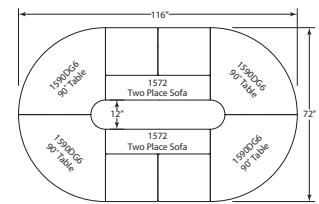
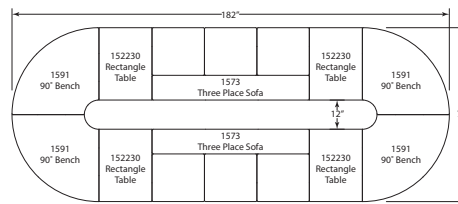
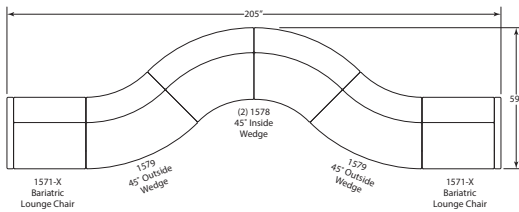
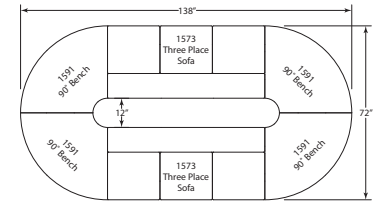
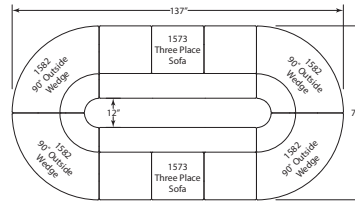
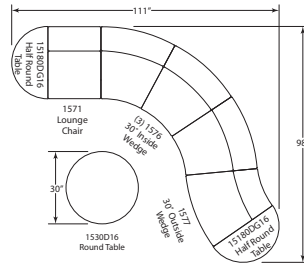
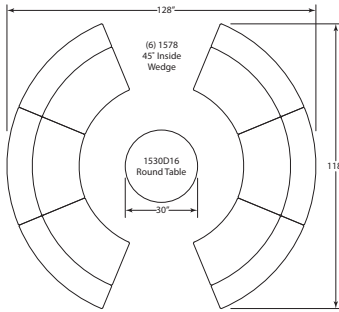
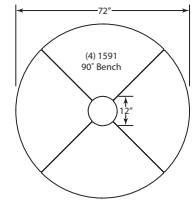
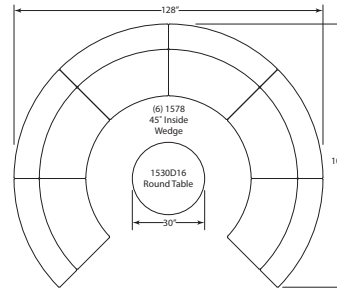
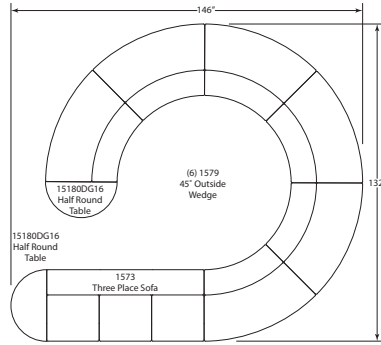
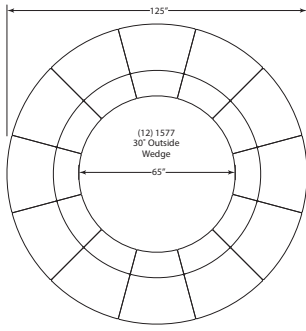

Configuration Examples





Configuration Examples



| ARM CAPS | OPTION #: | SPECIFICATIONS LIST PRICES AVAILABILITY: | | | | | | | | | | | | | |
|---|--------------|--|------------|----------|----------|----------|----------|----------|----------|----------|----------|----------|-----------|-----------|-----------|
| FULLY UPHOLSTERED ARM  | | Overall: 2.5"w 30.5"d 18"h COM: 1.5 yds. | | | | | | | | | | | | | |
| | | COM | COL | 1 | 2 | 3 | 4 | 5 | 6 | 7 | 8 | 9 | 10 | L1 | L2 |
| | A1 | 222 | N/A | 282 | 311 | 341 | 371 | 400 | 430 | 460 | 489 | 519 | 549 | N/A | N/A |
| | | <i>Fully Upholstered Arm (Specify Fabric)</i> | | | | | | | | | | | | | |
| | A1-R | 77 | N/A | 155 | 197 | 237 | 279 | 321 | 362 | 403 | 446 | 485 | 529 | N/A | N/A |
| | | <i>Replacement Upholstery Covers</i> | | | | | | | | | | | | | |
| | | Available: Facelift Serpentine Lounge Units | | | | | | | | | | | | | |
| UPHOLSTERED ARM / EXPOSED WOOD ARM CAP  | | Overall: 2.5"w 30.5"d 18.5"h COM: 1.5 yds. | | | | | | | | | | | | | |
| | | COM | COL | 1 | 2 | 3 | 4 | 5 | 6 | 7 | 8 | 9 | 10 | L1 | L2 |
| | A1W | 289 | N/A | 366 | 405 | 443 | 482 | 520 | 559 | 597 | 636 | 675 | 713 | N/A | N/A |
| | | <i>Upholstered Arm / Exposed Wood Arm Cap (Specify Fabric & Finish)</i> | | | | | | | | | | | | | |
| | A1W-R | 77 | N/A | 155 | 197 | 237 | 279 | 321 | 362 | 403 | 446 | 485 | 529 | N/A | N/A |
| | | <i>Replacement Upholstery Covers</i> | | | | | | | | | | | | | |
| | | Available: Facelift Serpentine Lounge Units | | | | | | | | | | | | | |
| UPHOLSTERED ARM / CONTRASTING FABRIC / VINYL ARM CAP  | | Overall: 2.5"w 30.5"d 18"h COM: 1.5 yds. | | | | | | | | | | | | | |
| | | COM | COL | 1 | 2 | 3 | 4 | 5 | 6 | 7 | 8 | 9 | 10 | L1 | L2 |
| | A1U | 278 | N/A | 352 | 389 | 426 | 463 | 500 | 537 | 575 | 612 | 649 | 686 | N/A | N/A |
| | | <i>Upholstered Arm / Contrasting Fabric / Vinyl Arm Cap (Specify Fabric & Vinyl)</i> | | | | | | | | | | | | | |
| | A1U-R | 77 | N/A | 155 | 197 | 237 | 279 | 321 | 362 | 403 | 446 | 485 | 529 | N/A | N/A |
| | | <i>Replacement Upholstery Covers</i> | | | | | | | | | | | | | |
| | | Available: Facelift Serpentine Lounge Units | | | | | | | | | | | | | |
| INTERIM UPHOLSTERED ARM / EXPOSED WOOD ARM CAP  | | Overall: 3"w 13.5"d 6"h COM: .75 yds. | | | | | | | | | | | | | |
| | | COM | COL | 1 | 2 | 3 | 4 | 5 | 6 | 7 | 8 | 9 | 10 | L1 | L2 |
| | A2W | 289 | N/A | 366 | 405 | 443 | 482 | 520 | 559 | 597 | 636 | 675 | 713 | N/A | N/A |
| | | <i>Interim Upholstered Arm / Exposed Wood Arm Cap (Specify Fabric & Finish)</i> | | | | | | | | | | | | | |
| | A2W-R | 67 | N/A | 135 | 171 | 206 | 243 | 279 | 315 | 350 | 388 | 422 | 460 | N/A | N/A |
| | | <i>Replacement Upholstery Covers</i> | | | | | | | | | | | | | |
| | | Available: Facelift Serpentine Lounge & Wedge Units | | | | | | | | | | | | | |

| ARM CAPS / TABLET ARMS | OPTION #: | SPECIFICATIONS LIST PRICES AVAILABILITY: | | | | | | | | | | | | | |
|---|--|--|-----|---|---|---|---|---|---|---|----|----|----|----|----|
| <p>UPHOLSTERED / URETHANE TASK ARM</p>  | <p><i>Overall: 3.25"w 9.5"d 18"h</i> <i>COM: .75 yds.</i></p> <table border="1"> <thead> <tr> <th>COM</th> <th>COL</th> <th>1</th> <th>2</th> <th>3</th> <th>4</th> <th>5</th> <th>6</th> <th>7</th> <th>8</th> <th>9</th> <th>10</th> <th>L1</th> <th>L2</th> </tr> </thead> </table> <p>A5 \$281 <i>Outside Urethane Task Arm (Black)</i></p> <p>A6 \$219 <i>Inside Urethane Task Arm (Black)</i></p> <p>Available: Facelift Serpentine Lounge & Wedge Units</p> | COM | COL | 1 | 2 | 3 | 4 | 5 | 6 | 7 | 8 | 9 | 10 | L1 | L2 |
| COM | COL | 1 | 2 | 3 | 4 | 5 | 6 | 7 | 8 | 9 | 10 | L1 | L2 | | |
| <p>POLE SWIVEL TABLET ARM</p>  | <p><i>Overall: 14.25" Diameter 22.5"h</i></p> <p>PT \$556 (Pole & Black Laminate Tablet)</p> <p>ST-1 \$603 (Pole & Veneer Tablet)</p> <p>ST-2 \$698 (Pole & White Solid Surface Tablet)</p> <p>Available: Facelift Serpentine Lounge & Wedge End Units</p> | | | | | | | | | | | | | | |

| LEGS / CASTERS / PUSH BAR | OPTION #: | SPECIFICATIONS LIST PRICES AVAILABILITY: |
|---|---|--|
| <p>BRUSHED ALUMINUM ROUND LEGS</p>  | <p>ARL</p> <p>Standard Leg On All Serpentine Units - No Charge <i>(Brushed Aluminum Finish)</i></p> <p><i>Available: Facelift Serpentine Collection</i></p> | |
| <p>WOOD ROUND LEGS</p>  | <p>WR</p> <p>Deduct \$80 (Set Of 4) <i>Wood Round Leg (Specify Finish)</i></p> <p><i>Available: Facelift Serpentine Collection</i></p> | |
| <p>CASTERS</p>  | <p>CS \$120 (Set Of 2) <i>Dual Wheel / Non-Locking Casters (Black Finish)</i></p> <p>CL \$140 (Set Of 2) <i>Dual Wheel / Locking Casters (Black Finish)</i></p> <p><i>Available: Facelift Serpentine Lounge Units</i></p> | |
| <p>PUSH BAR</p>  | <p>PB \$267 <i>(Black Finish)</i></p> <p><i>Available: Facelift Serpentine Lounge Units</i></p> | |

| POWER / COVERS | OPTION #: | SPECIFICATIONS LIST PRICES AVAILABILITY: |
|--|---|--|
| <p>POWER / DATA MODULE</p>  <p>PM1 Power / Data Module</p>  <p>PM2 Power Module</p>  <p>USB-1 Dual Charging USB</p> | <p>PM1</p> <p>PM2</p> <p>USB-1</p> | <p>PM1 Overall: 5.25"w 1.25"d 4.25"h PM2 Overall: 2"w 2"d .125"h USB-1 Overall: 2"w 2"d .125"h</p> <p>\$859 Power/Data Module (1-Power / 1-USB 2 Port Simplex Charger Standard) <i>Vertical / Horizontal Mount Power Module. Price Varies By Socket. Contact Customer Service For Quote. (Additional Colors Available)</i></p> <p>\$238 Power Module (1-Power) <i>Spill-Proof Technology / Multiple Finish Options / Storm Color Standard (Specify Left or Right Facing)</i></p> <p>\$238 Dual Charging USB (2 Port Simplex Charger Standard) <i>Spill-Proof Technology / 2 Amps Per Port / Multiple Finish Options / Storm Color Standard (Specify Left or Right Facing)</i></p> <p><i>Available: Facelift Serpentine Collection</i></p> |
| <p>CONTRASTING COVERS</p>  | <p>CC</p> | <p>\$129</p> <p><i>NOTE: If Two Or More Upholsteries Or Leathers Are Used On Any Piece Of Furniture, Then A Contrast Charge Will Apply Per Order. When Using Trinity Upholstery, The Higher Priced Upholstery Grade Will Be Used In Pricing, Unless It's Trinity Leather With Fabric Contrast Welt, Or COM With Trinity Contrast Welt, Then Contact Customer Service For Pricing.</i></p> <p><i>Available: Facelift Serpentine Collection</i></p> |

Facelift Tuxedo

LOUNGE SLEEPER

Effective: March 1, 2025

T R I N I T Y

Date:

Page:

Modification:

Description:

DESCRIPTION:

- Upholstery Frames: Plywood & Hardwood
- Seat: High Density Polyurethane Foam Over Sheet Webbing
- Back: High Density Poly-Dacron Foam Over Hardwood Plywood
- Upholstered Covers: Attached w/ Velcro / Removable For Maintenance (Seat Only)
- Antimicrobial Moisture Barrier Fully Encapsulates Seat Area
- Removable Bolster Pillows (2)
- Double Needle Stitching Standard
- Wood Legs Front / Casters Rear
- Leather Upholstery Not Available / Storage Drawer Not Available
- Lifetime Warranty

OPTIONS:

- ASL Aluminum Square Legs (Set Of 4).....\$382
- ARL Brushed Aluminum Round Legs (Set Of 4).....\$346
- SLC Swivel Locking Casters (Set Of 4).....\$292
- Surface Caps..... SEE OPTIONS
- Pole Swivel Tablet Arm..... SEE OPTIONS
- PM1 Power/Data Module (1-Power / 1-USB 2 Port Simplex Charger)\$859
- USB-1 USB In Back (2 Ports Available - Specify Left or Right Facing).....\$238
- PM2 Power Module (1-Power - Specify Left or Right Facing).....\$238
- Feather Down & Polyester Pillows Available (See Page 5)

LOUNGE SLEEPER

ITEM #:

SPECIFICATIONS | GRADES | LIST PRICES:

SLEEPER / FULLY UPHOLSTERED

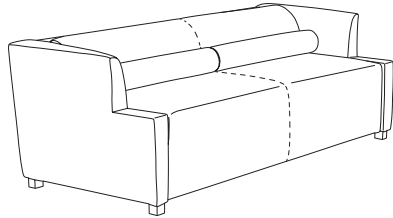

Overall: 87" w 36" d 28" h **Arm:** 28" h **COM:** 10.25 yds.
Seat: 76" w 30" d 18" h **Weight:** 185 lbs. **COL:** n/a

| COM | COL | 1 | 2 | 3 | 4 | 5 | 6 | 7 | 8 | 9 | 10 | L1 | L2 |
|------|-----|------|------|------|------|------|------|------|------|------|------|-----|-----|
| 4165 | N/A | 4431 | 4678 | 4925 | 5172 | 5419 | 5666 | 5913 | 6160 | 6406 | 6653 | N/A | N/A |

Tight Seat & Back / Removable Upholstery (Seat Only) / 1000 lb. Weight Capacity

1603

1603-R

Call For Pricing
 Replacement Seat Upholstery









Our Tuxedo Lounge reveals a fully suspended adult sleep surface by simply raising the back cushion; a transformation requiring no additional space in the patient room.



Closed Sitting Position:



Open Sleep Position:

| LEGS / CASTERS / SURFACE CAPS / TABLET ARMS / POWER / COVERS | OPTION #: | SPECIFICATIONS LIST PRICES AVAILABILITY: |
|---|---|--|
| ALUMINUM SQUARE LEGS | | Overall: 2.25"w 2.25"d 2.25"h |
|  | ASL | \$382 (Set Of 4) <i>(Brushed Finish)</i> Available: Facelift Tuxedo Collection |
| BRUSHED ALUMINUM ROUND LEGS | | Overall: 2" Diameter 5"h |
|  | ARL | \$346 (Set Of 4) <i>(Brushed Aluminum Finish)</i> Available: Facelift Tuxedo Collection |
| SWIVEL LOCKING CASTERS | | Overall: 3"h |
|  | SLC | \$292 (Set Of 4) <i>(Swivel Locking Plastic Casters) NOTE: Casters Are Recessed Under The Sofa Unit And Will Not Be Visible</i> Available: Facelift Tuxedo Collection |
| SURFACE CAPS | | Back Cap Size: 82"w 7"d .50"h Arm Cap Size: 5"w 10"d .50"h |
|  | CSC-1 CSC-2 | \$570 (Back & Arms) <i>Solid Surface (White)</i> \$197 (Arms Only) <i>Solid Surface (White)</i> Available: Facelift Tuxedo Collection |
| Surface Caps For Back & Arms Shown In White Solid Surface | | |
| POLE SWIVEL TABLET ARM | | Overall: 14.25" Diameter 22.5"h |
|  | PT ST-1 ST-2 | \$556 (Pole & Black Laminate Tablet) \$603 (Pole & Veneer Tablet) \$698 (Pole & White Solid Surface Tablet) Available: Facelift Serpentine Lounge & Wedge End Units |
| POWER / DATA MODULE | | PM1 Overall: 5.25"w 1.25"d 4.25"h PM2 Overall: 2"w 2"d .125"h USB-1 Overall: 2"w 2"d .125"h |
|  |  | PM1 |
|  | | PM2 |
| USB-1 Dual Charging USB | | USB-1 |
| PM1 Power / Data Module | | |
| PM2 Power Module | | |
| | | \$859 Power/Data Module (1-Power / 1-USB 2 Port Simplex Charger Standard) <i>Vertical / Horizontal Mount Power Module. Price Varies By Socket. Contact Customer Service For Quote. (Additional Colors Available)</i> |
| | | \$238 Power Module (1-Power) <i>Spill-Proof Technology / Multiple Finish Options / Storm Color Standard (Specify Left or Right Facing)</i> |
| | | \$238 Dual Charging USB (2 Port Simplex Charger Standard) <i>Spill-Proof Technology / 2 Amps Per Port / Multiple Finish Options / Storm Color Standard (Specify Left or Right Facing)</i> Available: Facelift Tuxedo Collection |
| CONTRASTING COVERS | | Overall: N/A |
|  | CC | \$129 <i>NOTE: If Two Or More Upholsteries Or Leathers Are Used On Any Piece Of Furniture, Then A Contrast Charge Will Apply Per Order. When Using Trinity Upholstery, The Higher Priced Upholstery Grade Will Be Used In Pricing, Unless It's Trinity Leather With Fabric Contrast Welt, Or COM With Trinity Contrast Welt, Then Contact Customer Service For Pricing.</i> Available: Facelift Tuxedo Collection |

Facelift Prime

LOUNGE

Effective: March 1, 2025

T R I N I T Y

Date:

Page:

Modification:

Description:

DESCRIPTION:

- Upholstery Frames: Steel, Plywood & Hardwood
- Seat: High Density Polyurethane Foam Over Strap Webbing
- Back: High Density Polyurethane Foam Over Sinuous Wire Springs
- Upholstered Covers: Attached w/ Velcro / Removable For Maintenance
- Exposed Wood Legs: Solid Hardwood / Removable For Maintenance
- Antimicrobial Moisture Barrier Fully Encapsulates All Foam Areas
- Leather Upholstery Not Available
- Lifetime Warranty

OPTIONS:

- WAC-1 Solid Wood Arm Caps (Set Of 2) \$155
- UAC-1 Black Urethane Arm Caps (Set Of 2) \$206
- ARL Brushed Aluminum Round Legs (Set Of 4) \$346
- PM1 Power/Data Module (1-Power / 1-USB 2 Port Simplex Charger) \$859
(Additional Power/Data Modules Available - See Prime Lounge Options)

Feather Down & Polyester Pillows Available (See Page 5)
Specify Exposed Wood Finish (See Page 6)
Tablet Arm / Cup Holder Options (See Facelift Prime Lounge Options Pages)
Biscuit Tufting Available Upon Request (Contact Customer Service For Pricing)

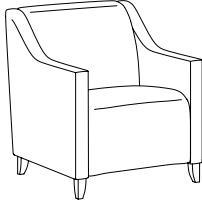
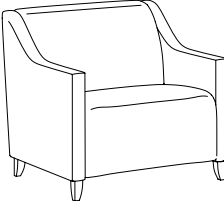
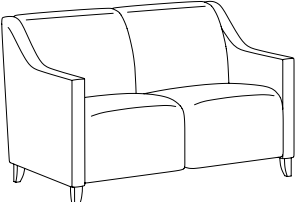
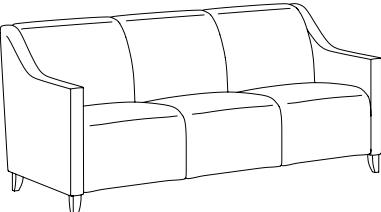
| LOUNGE | | ITEM #: | SPECIFICATIONS GRADES LIST PRICES: | | | | | | | | | | | | | |
|---|--|--|--|------------|----------|-------------------------|----------|----------|-----------------------|----------|----------|----------|----------|-----------|-----------|-----------|
|  | LOUNGE CHAIR / FULLY UPHOLSTERED | | Overall: 28"w 32.5"d 34"h | | | Arm: 25"h | | | COM: 5 yds. | | | | | | | |
| | | | Seat: 23"w 20.5"d 18"h | | | Weight: 90 lbs. | | | COL: n/a | | | | | | | |
| | | | COM | COL | 1 | 2 | 3 | 4 | 5 | 6 | 7 | 8 | 9 | 10 | L1 | L2 |
| | 1701 | 1564 | N/A | 1753 | 1890 | 2027 | 2164 | 2301 | 2439 | 2576 | 2713 | 2850 | 2987 | N/A | N/A | |
| | | <i>Tight Seat & Back / Removable Upholstery / 500 lb. Weight Capacity</i> | | | | | | | | | | | | | | |
| | 1701-R | 280 | N/A | 565 | 715 | 866 | 1016 | 1166 | 1316 | 1466 | 1616 | 1767 | 1917 | N/A | N/A | |
| | | <i>Replacement Upholstery Covers</i> | | | | | | | | | | | | | | |
|  | BARIATRIC LOUNGE CHAIR / FULLY UPHOLSTERED | | Overall: 34"w 32.5"d 34"h | | | Arm: 25"h | | | COM: 5.5 yds. | | | | | | | |
| | | | Seat: 29"w 20.5"d 18"h | | | Weight: 100 lbs. | | | COL: n/a | | | | | | | |
| | | | COM | COL | 1 | 2 | 3 | 4 | 5 | 6 | 7 | 8 | 9 | 10 | L1 | L2 |
| | 1701-X | 1955 | N/A | 2151 | 2303 | 2454 | 2606 | 2758 | 2909 | 3061 | 3212 | 3364 | 3515 | N/A | N/A | |
| | | <i>Tight Seat & Back / Removable Upholstery / 1000 lb. Weight Capacity</i> | | | | | | | | | | | | | | |
| | 1701-XR | 280 | N/A | 597 | 763 | 929 | 1095 | 1261 | 1427 | 1593 | 1759 | 1925 | 2091 | N/A | N/A | |
| | | <i>Replacement Upholstery Covers</i> | | | | | | | | | | | | | | |
|  | TWO PLACE SOFA / FULLY UPHOLSTERED | | Overall: 51"w 32.5"d 34"h | | | Arm: 25"h | | | COM: 7.25 yds. | | | | | | | |
| | | | Seat: 46"w 20.5"d 18"h | | | Weight: 155 lbs. | | | COL: n/a | | | | | | | |
| | | | COM | COL | 1 | 2 | 3 | 4 | 5 | 6 | 7 | 8 | 9 | 10 | L1 | L2 |
| | 1702 | 2400 | N/A | 2674 | 2876 | 3078 | 3280 | 3482 | 3684 | 3886 | 4088 | 4290 | 4492 | N/A | N/A | |
| | | <i>Tight Seat & Back / Removable Upholstery / 1000 lb. Weight Capacity</i> | | | | | | | | | | | | | | |
| | 1702-R | 412 | N/A | 832 | 1054 | 1275 | 1496 | 1717 | 1939 | 2160 | 2381 | 2603 | 2824 | N/A | N/A | |
| | | <i>Replacement Upholstery Covers</i> | | | | | | | | | | | | | | |
|  | THREE PLACE SOFA / FULLY UPHOLSTERED | | Overall: 74"w 32.5"d 34"h | | | Arm: 25"h | | | COM: 9.75 yds. | | | | | | | |
| | | | Seat: 69"w 20.5"d 18"h | | | Weight: 215 lbs. | | | COL: n/a | | | | | | | |
| | | | COM | COL | 1 | 2 | 3 | 4 | 5 | 6 | 7 | 8 | 9 | 10 | L1 | L2 |
| | 1703 | 3242 | N/A | 3614 | 3888 | 4162 | 4436 | 4710 | 4985 | 5259 | 5533 | 5807 | 6081 | N/A | N/A | |
| | | <i>Tight Seat & Back / Removable Upholstery / 1000 lb. Weight Capacity</i> | | | | | | | | | | | | | | |
| | 1703-R | 520 | N/A | 1092 | 1393 | 1693 | 1993 | 2294 | 2594 | 2894 | 3195 | 3495 | 3795 | N/A | N/A | |
| | | <i>Replacement Upholstery Covers</i> | | | | | | | | | | | | | | |

DESCRIPTION:



- Upholstery Frames: Steel, Plywood & Hardwood
- Seat: High Density Polyurethane Foam Over Strap Webbing
- Back: High Density Polyurethane Foam Over Sinuous Wire Springs
- Upholstered Covers: Attached w/ Velcro / Removable For Maintenance
- Exposed Wood Legs: Solid Hardwood / Removable For Maintenance
- Antimicrobial Moisture Barrier Fully Encapsulates All Foam Areas
- Leather Upholstery Not Available
- Lifetime Warranty

OPTIONS:



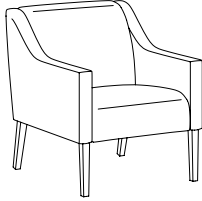
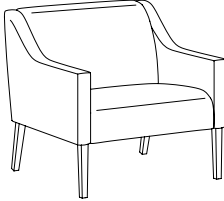
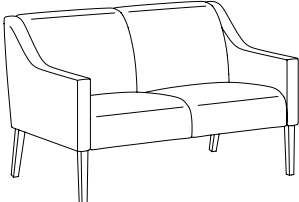
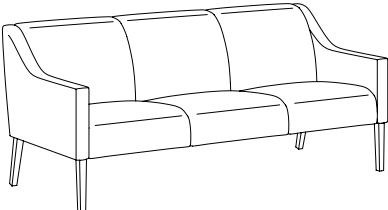

- WAC-1 Solid Wood Arm Caps (Set Of 2)\$155
- UAC-1 Black Urethane Arm Caps (Set Of 2).....\$206
- PM1 Power/Data Module (1-Power / 1-USB 2 Port Simplex Charger)\$859
(Additional Power/Data Modules Available - See Prime Lounge Options)

Feather Down & Polyester Pillows Available (See Page 5)
 Specify Exposed Wood Finish (See Page 6)
 Tablet Arm / Cup Holder Options (See Facelift Prime Lounge Options Pages)
 Biscuit Tufting Available Upon Request (Contact Customer Service For Pricing)

| LOUNGE | | ITEM #: | SPECIFICATIONS GRADES LIST PRICES: | | | | | | | | | | | | |
|---|--|---|--|------------|-------------------------|----------|-----------------------|----------|----------|----------|----------|----------|----------|-----------|-----------|
|  | <p>LOUNGE CHAIR / FULLY UPHOLSTERED</p> | | Overall: 28"w 32.5"d 34"h | | Arm: 25"h | | COM: 4.75 yds. | | | | | | | | |
| | | | Seat: 23"w 20.5"d 18"h | | Weight: 80 lbs. | | COL: n/a | | | | | | | | |
| | | | COM | COL | 1 | 2 | 3 | 4 | 5 | 6 | 7 | 8 | 9 | 10 | L1 |
| | 1711 | 1662 | N/A | 1831 | 1961 | 2091 | 2221 | 2351 | 2480 | 2610 | 2740 | 2870 | 3000 | N/A | N/A |
| | | <i>Tight Seat & Back / Removable Upholstery / 350 lb. Weight Capacity</i> | | | | | | | | | | | | | |
| | 1711-R | 262 | N/A | 532 | 674 | 817 | 959 | 1101 | 1243 | 1386 | 1528 | 1670 | 1813 | N/A | N/A |
| | | <i>Replacement Upholstery Covers</i> | | | | | | | | | | | | | |
|  | <p>BARIATRIC LOUNGE CHAIR / FULLY UPHOLSTERED</p> | | Overall: 34"w 32.5"d 34"h | | Arm: 25"h | | COM: 5.25 yds. | | | | | | | | |
| | | | Seat: 29"w 20.5"d 18"h | | Weight: 90 lbs. | | COL: n/a | | | | | | | | |
| | | | COM | COL | 1 | 2 | 3 | 4 | 5 | 6 | 7 | 8 | 9 | 10 | L1 |
| | 1711-X | 1931 | N/A | 2114 | 2258 | 2403 | 2547 | 2691 | 2835 | 2980 | 3124 | 3268 | 3413 | N/A | N/A |
| | | <i>Tight Seat & Back / Removable Upholstery / 500 lb. Weight Capacity</i> | | | | | | | | | | | | | |
| | 1711-XR | 262 | N/A | 564 | 722 | 880 | 1038 | 1196 | 1354 | 1512 | 1670 | 1828 | 1986 | N/A | N/A |
| | | <i>Replacement Upholstery Covers</i> | | | | | | | | | | | | | |
|  | <p>TWO PLACE SOFA / FULLY UPHOLSTERED</p> | | Overall: 51"w 32.5"d 34"h | | Arm: 25"h | | COM: 6.5 yds. | | | | | | | | |
| | | | Seat: 46"w 20.5"d 18"h | | Weight: 140 lbs. | | COL: n/a | | | | | | | | |
| | | | COM | COL | 1 | 2 | 3 | 4 | 5 | 6 | 7 | 8 | 9 | 10 | L1 |
| | 1712 | 2559 | N/A | 2780 | 2961 | 3141 | 3322 | 3502 | 3682 | 3863 | 4043 | 4224 | 4404 | N/A | N/A |
| | | <i>Tight Seat & Back / Removable Upholstery / 750 lb. Weight Capacity</i> | | | | | | | | | | | | | |
| | 1712-R | 388 | N/A | 762 | 959 | 1157 | 1355 | 1552 | 1750 | 1947 | 2145 | 2343 | 2540 | N/A | N/A |
| | | <i>Replacement Upholstery Covers</i> | | | | | | | | | | | | | |
|  | <p>THREE PLACE SOFA / FULLY UPHOLSTERED</p> | | Overall: 74"w 32.5"d 34"h | | Arm: 25"h | | COM: 8.5 yds. | | | | | | | | |
| | | | Seat: 69"w 20.5"d 18"h | | Weight: 200 lbs. | | COL: n/a | | | | | | | | |
| | | | COM | COL | 1 | 2 | 3 | 4 | 5 | 6 | 7 | 8 | 9 | 10 | L1 |
| | 1713 | 3352 | N/A | 3645 | 3883 | 4122 | 4360 | 4598 | 4836 | 5074 | 5312 | 5550 | 5788 | N/A | N/A |
| | | <i>Tight Seat & Back / Removable Upholstery / 750 lb. Weight Capacity</i> | | | | | | | | | | | | | |
| | 1713-R | 490 | N/A | 985 | 1245 | 1506 | 1767 | 2028 | 2289 | 2550 | 2810 | 3071 | 3332 | N/A | N/A |
| | | <i>Replacement Upholstery Covers</i> | | | | | | | | | | | | | |

| ARM CAPS / LEGS | OPTION #: | SPECIFICATIONS LIST PRICES AVAILABILITY: |
|---|---------------------|--|
| <p>SOLID WOOD ARM CAPS</p>  | <p>WAC-1</p> | <p><i>Overall: 3.25"w 17.5"d 1.25"h</i></p> <hr/> <p>\$155 (Set Of 2) <i>(Specify Finish)</i></p> <p><i>Available: Facelift Prime Collection</i></p> |
| <p>URETHANE ARM CAPS</p>  | <p>UAC-1</p> | <p><i>Overall: 3.25"w 17.5"d 1.25"h</i></p> <hr/> <p>\$206 (Set Of 2) <i>(Black Urethane)</i></p> <p><i>Available: Facelift Prime Collection</i></p> |
| <p>BRUSHED ALUMINUM ROUND LEGS</p>  | <p>ARL</p> | <p><i>Overall: 2" Diameter 5"h</i></p> <hr/> <p>\$346 (Set Of 4) <i>(Brushed Aluminum Finish)</i></p> <p><i>Available: Facelift Prime Lounge Collection (1701, 1701-X, 1702, 1703)</i></p> |

| TABLET ARMS / POWER / COVERS | OPTION #: | SPECIFICATIONS LIST PRICES AVAILABILITY: |
|---|----------------------|--|
| TABLET ARMS / CUP HOLDER | | |
|  <p>Laminate Tablet Arm Shown w/ Cup Holder</p> | | <p>Overall: 14" Diameter .75"h</p> |
|  <p>Veneer Tablet Arm Shown w/ Cup Holder</p> | <p>TA-L</p> | <p>\$509 Tablet Arm With 360° Rotation - High Pressure Laminate. (Specify Laminate / Specify Left Or Right Facing Arm Location)</p> |
|  <p>Veneer Tablet Arm Shown w/ Cup Holder</p> | <p>TA-V</p> | <p>\$580 Tablet Arm With 360° Rotation - Sunburst Cherry Veneer. (Specify Finish / Specify Left Or Right Facing Arm Location)</p> |
|  <p>Veneer Tablet Arm Shown w/ Cup Holder</p> | <p>TA-C</p> | <p>\$698 Tablet Arm With 360° Rotation - White Solid Surface. (Available In White Only / Specify Left Or Right Facing Arm Location)</p> |
|  <p>Solid Surface Tablet Arm Shown w/ Cup Holder</p> | <p>CH-1</p> | <p>\$129 Black Plastic Cup Holder (Only Available If Used With Tablet Arm)</p> |
|  <p>Solid Surface Tablet Arm Shown w/ Cup Holder</p> | <p>CH-2</p> | <p>\$186 Spun Aluminum Cup Holder (Only Available If Used With Tablet Arm)</p> |
| <p>Available: Facelift Prime Collection</p> | | |
| FOLD DOWN TABLET ARM | | |
| <p>Overall: 14" Diameter .75"h</p> | | |
|  | <p>FDTA-L</p> | <p>\$1065 Tablet Arm With 360° Rotation - High Pressure Laminate. (Specify Laminate / Specify Left Or Right Facing Arm Location)</p> |
|  | <p>FDTA-V</p> | <p>\$1136 Tablet Arm With 360° Rotation - Sunburst Cherry Veneer. (Specify Finish / Specify Left Or Right Facing Arm Location)</p> |
|  | <p>FDTA-C</p> | <p>\$1278 Tablet Arm With 360° Rotation - White Solid Surface. (Available In White Only / Specify Left Or Right Facing Arm Location)</p> |
| <p>Available: Facelift Prime Collection</p> | | |
| DOUBLE ARTICULATING / SWIVEL TABLET ARM | | |
| <p>Overall: 14" Diameter .75"h</p> | | |
|  | <p>ATA-L</p> | <p>\$983 Tablet Arm With 360° Rotation - High Pressure Laminate. (Specify Laminate / Specify Left Or Right Facing Arm Location)</p> |
|  <p>ATA-L Double Articulating / Swivel Tablet Arm</p> | <p>ATA-V</p> | <p>\$1055 Tablet Arm With 360° Rotation - Sunburst Cherry Veneer. (Specify Finish / Specify Left Or Right Facing Arm Location)</p> |
|  | <p>ATA-C</p> | <p>\$1173 Tablet Arm With 360° Rotation - White Solid Surface. (Available In White Only / Specify Left Or Right Facing Arm Location)</p> |
|  | <p>CH-1</p> | <p>\$129 Black Plastic Cup Holder (Only Available If Used With Tablet Arm)</p> |
|  <p>ATA-L w/ CH-1 Black Plastic Cup Holder</p> | <p>CH-2</p> | <p>\$186 Spun Aluminum Cup Holder (Only Available If Used With Tablet Arm)</p> |
| <p>Available: Facelift Prime Collection</p> | | |

| TABLET ARMS / POWER / COVERS | OPTION #: | SPECIFICATIONS LIST PRICES AVAILABILITY: |
|--|--|--|
| POWER / DATA MODULE | | |
|  <p>PM1 Power / Data Module</p> | <p>PM1 Overall: 5.25"w 1.25"d 4.25"h PM2 Overall: 2"w 2"d .125"h USB-1 Overall: 2"w 2"d .125"h</p> | <p>PM1 \$859 Power/Data Module (1-Power / 1-USB 2 Port Simplex Charger Standard) <i>Vertical / Horizontal Mount Power Module. Price Varies By Socket. Contact Customer Service For Quote. (Additional Colors Available)</i></p> |
|  <p>PM2 Power Module</p>  <p>USB-1 Dual Charging USB</p> | <p>PM2 \$238 Power Module (1-Power) <i>Spill-Proof Technology / Multiple Finish Options / Storm Color Standard (Specify Left or Right Facing)</i></p> <p>USB-1 \$238 Dual Charging USB (2 Port Simplex Charger Standard) <i>Spill-Proof Technology / 2 Amps Per Port / Multiple Finish Options / Storm Color Standard (Specify Left or Right Facing)</i></p> | <p><i>Available: Facelift Prime Low Leg Lounge</i></p> |
| CONTRASTING COVERS | | |
|  | <p>Overall: N/A</p> | <p>CC \$129 <i>NOTE: If Two Or More Upholsteries Or Leathers Are Used On Any Piece Of Furniture, Then A Contrast Charge Will Apply Per Order. When Using Trinity Upholstery, The Higher Priced Upholstery Grade Will Be Used In Pricing, Unless It's Trinity Leather With Fabric Contrast Welt, Or COM With Trinity Contrast Welt, Then Contact Customer Service For Pricing.</i></p> <p><i>Available: Facelift Prime Collection</i></p> |

Facelift Prime

GUEST / TANDEM / BENCHES / TABLES

Effective: March 1, 2025

T R I N I T Y

Date:

Page:

Modification:

Description:

DESCRIPTION:

- Upholstery Frames: Steel, Plywood & Hardwood
- Seat: High Density Polyurethane Foam Over Strap Webbing
- Back: High Density Polyurethane Foam Over Sinuous Wire Springs
- Upholstered Covers: Attached w/ Velcro / Removable For Maintenance
- Exposed Wood Legs: Solid Hardwood / Removable For Maintenance
- Antimicrobial Moisture Barrier Fully Encapsulates All Foam Areas
- Leather Upholstery Not Available
- Lifetime Warranty

Behavioral Chair:

- Upholstery Frames: Steel, Plywood & Hardwood
- Recycled 22" Wide 1 1/2" X 1 1/2" Steel Inner-frame
- Seat: High Density Polyurethane Foam Over Sheet Webbing
- Back: High Density Polyurethane Foam Over Hardwood Plywood

- Arms: Held In Place By Non-Removable Helical Fasteners
- Exposed Wood Legs: Solid Hardwood / Removable For Maintenance
- Full Underbody Panel
- Tamperproof Screws On Seat Pan
- Full Clean-Out Between Seat & Back
- No Exposed Hardware Or "Pick Points"
- All Staples Are Concealed & Inaccessible

Behavioral Chair Enhancements:

- Vacuum Formed ABS Under Panel With Drain
- Additional Weight Can Be Added To The Seat
- Can Be Bolted To Floor
- Replaceable Seat Cover w/ Antimicrobial Moisture Barrier
- Bariatric 30" Wide 500lbs. Available

OPTIONS:

- WAC-2 Solid Wood Arm Caps (Set Of 2)\$143
- UAC-2 Black Urethane Arm Caps (Set Of 2)\$193
- PM1 Power/Data Module (1-Power / 1-USB 2 Port Simplex Charger)\$859
(Additional Power/Data Modules Available - See Prime Options)

Tablet Arm / Cup Holder Options (See Facelift Prime Guest/Tandem Options Page)
Specify Exposed Wood Finish (See Page 6)

Biscuit Tufting Available Upon Request (Contact Customer Service For Pricing)

NOTE: All Seating Configurations Are Viewed From Left To Right Facing. Please Attach A Layout Showing Seating Configuration w/ Your Order. Assembled Units Must Be Shipped In Configurations Of 3 Or Less.

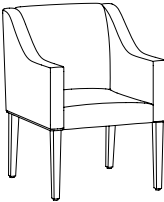
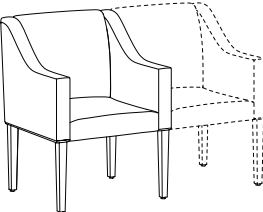
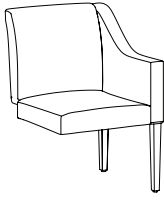
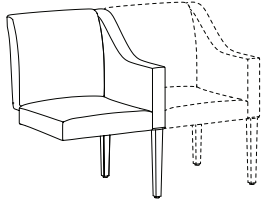
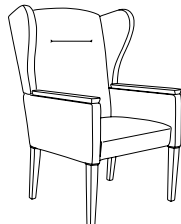
| GUEST / TANDEM | | ITEM #: | SPECIFICATIONS GRADES LIST PRICES: | | | | | | | | | | | | | |
|---|---|------------|--|----------|----------|--------------------|------------------------|----------|--------------------|-----------------|----------|-----------|-----------|-----------|-----|--|
|  | ARM SIDE CHAIR | | Overall: 24"w 28"d 34"h | | | Arm: 26"h | | | COM: 4 yds. | | | | | | | |
| | Seat: 19"w 20"d 19"h | | | | | | Weight: 60 lbs. | | | COL: n/a | | | | | | |
| | COM | COL | 1 | 2 | 3 | 4 | 5 | 6 | 7 | 8 | 9 | 10 | L1 | L2 | | |
| | 1720 | 1386 | N/A | 1526 | 1635 | 1743 | 1851 | 1959 | 2068 | 2176 | 2284 | 2392 | 2501 | N/A | N/A | |
| <i>Tight Seat & Back / Removable Upholstery / 350 lb. Weight Capacity</i> | | | | | | | | | | | | | | | | |
| | 1720-R | 181 | N/A | 408 | 526 | 645 | 764 | 882 | 1001 | 1119 | 1238 | 1356 | 1475 | N/A | N/A | |
| <i>Replacement Upholstery Covers</i> | | | | | | | | | | | | | | | | |
|  | ARM CHAIR / ACCEPTS SEAT ON RIGHT | | Overall: 24"w 28"d 34"h | | | Arm: 26"h | | | COM: 4 yds. | | | | | | | |
| | Seat: 19"w 20"d 19"h | | | | | | Weight: 60 lbs. | | | COL: n/a | | | | | | |
| | COM | COL | 1 | 2 | 3 | 4 | 5 | 6 | 7 | 8 | 9 | 10 | L1 | L2 | | |
| | 1720-C | 1386 | N/A | 1526 | 1635 | 1743 | 1851 | 1959 | 2068 | 2176 | 2284 | 2392 | 2501 | N/A | N/A | |
| <i>Tight Seat & Back / Removable Upholstery / 350 lb. Weight Capacity</i> | | | | | | | | | | | | | | | | |
| | 1720-CR | 181 | N/A | 408 | 526 | 645 | 764 | 882 | 1001 | 1119 | 1238 | 1356 | 1475 | N/A | N/A | |
| <i>Replacement Upholstery Covers</i> | | | | | | | | | | | | | | | | |
|  | ARM CHAIR / ADD-A-SEAT | | Overall: 21.5"w 28"d 34"h | | | Arm: 26"h | | | COM: 3 yds. | | | | | | | |
| | Seat: 19"w 20"d 19"h | | | | | | Weight: 45 lbs. | | | COL: n/a | | | | | | |
| | COM | COL | 1 | 2 | 3 | 4 | 5 | 6 | 7 | 8 | 9 | 10 | L1 | L2 | | |
| | 1721 | 1052 | N/A | 1153 | 1232 | 1312 | 1391 | 1470 | 1550 | 1629 | 1709 | 1788 | 1867 | N/A | N/A | |
| <i>Tight Seat & Back / Removable Upholstery / 350 lb. Weight Capacity</i> | | | | | | | | | | | | | | | | |
| | 1721-R | 146 | N/A | 312 | 399 | 486 | 573 | 660 | 747 | 834 | 920 | 1007 | 1094 | N/A | N/A | |
| <i>Replacement Upholstery Covers</i> | | | | | | | | | | | | | | | | |
|  | ARM CHAIR / ADD-A-SEAT / ACCEPTS SEAT ON RIGHT | | Overall: 21.5"w 28"d 34"h | | | Arm: 26"h | | | COM: 3 yds. | | | | | | | |
| | Seat: 19"w 20"d 19"h | | | | | | Weight: 45 lbs. | | | COL: n/a | | | | | | |
| | COM | COL | 1 | 2 | 3 | 4 | 5 | 6 | 7 | 8 | 9 | 10 | L1 | L2 | | |
| | 1721-C | 1052 | N/A | 1153 | 1232 | 1312 | 1391 | 1470 | 1550 | 1629 | 1709 | 1788 | 1867 | N/A | N/A | |
| <i>Tight Seat & Back / Removable Upholstery / 350 lb. Weight Capacity</i> | | | | | | | | | | | | | | | | |
| | 1721-CR | 146 | N/A | 312 | 399 | 486 | 573 | 660 | 747 | 834 | 920 | 1007 | 1094 | N/A | N/A | |
| <i>Replacement Upholstery Covers</i> | | | | | | | | | | | | | | | | |
|  | WINGBACK BEHAVIORAL HEALTH CHAIR / URETHANE ARMS | | Overall: 26"w 28.5"d 46"h | | | Arm: 26.5"h | | | COM: 4 yds. | | | | | | | |
| | Seat: 21"w 20"d 19"h | | | | | | Weight: 80 lbs. | | | COL: n/a | | | | | | |
| | COM | COL | 1 | 2 | 3 | 4 | 5 | 6 | 7 | 8 | 9 | 10 | L1 | L2 | | |
| | BH1722-WB | 2086 | N/A | 2188 | 2297 | 2405 | 2513 | 2621 | 2730 | 2838 | 2946 | 3054 | 3162 | N/A | N/A | |
| <i>Tight Seat & Back / Removable Upholstery Seat Only / 350 lb. Weight Capacity</i> | | | | | | | | | | | | | | | | |
| Meets Behavioral Health Requirements | | | | | | | | | | | | | | | | |

DESCRIPTION:

- Upholstery Frames: Steel, Plywood & Hardwood
- Seat: High Density Polyurethane Foam Over Strap Webbing
- Back: High Density Polyurethane Foam Over Sinuous Wire Springs
- Upholstered Covers: Attached w/ Velcro / Removable For Maintenance
- Exposed Wood Legs: Solid Hardwood / Removable For Maintenance
- Antimicrobial Moisture Barrier Fully Encapsulates All Foam Areas
- Leather Upholstery Not Available
- Lifetime Warranty

OPTIONS:

- WAC-2 Solid Wood Arm Caps (Set Of 2)\$143
- UAC-2 Black Urethane Arm Caps (Set Of 2).....\$193
- PM1 Power/Data Module (1-Power / 1-USB 2 Port Simplex Charger)\$859
(Additional Power/Data Modules Available - See Prime Options)
- Tablet Arm / Cup Holder Options (See Facelift Prime Guest/Tandem Options Pages)
- Specify Exposed Wood Finish (See Page 6)
- Biscuit Tufting Available Upon Request (Contact Customer Service For Pricing)

NOTE: All Seating Configurations Are Viewed From Left To Right Facing. Please Attach A Layout Showing Seating Configuration w/ Your Order. Assembled Units Must Be Shipped In Configurations Of 3 Or Less.

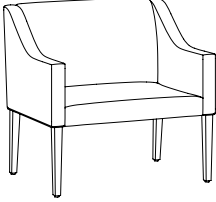
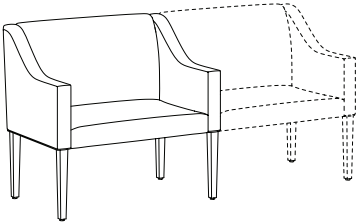
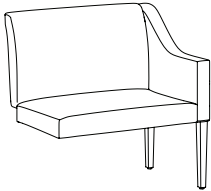
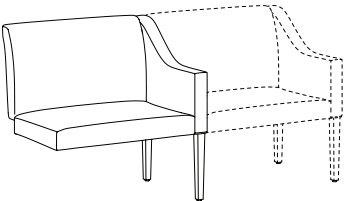
| TANDEM / BARIATRIC | | ITEM #: | SPECIFICATIONS GRADES LIST PRICES: | | | | | | | | | | | | | |
|---|----------------|---------|--|------------|----------|------------------------|----------|----------|-----------------------|----------|----------|----------|----------|-----------|-----------|-----------|
| BARIATRIC ARM SIDE CHAIR | | | Overall: 34"w 28"d 34"h | | | Arm: 26"h | | | COM: 4.25 yds. | | | | | | | |
| | | | Seat: 29"w 20"d 19"h | | | Weight: 65 lbs. | | | COL: n/a | | | | | | | |
|  | | | COM | COL | 1 | 2 | 3 | 4 | 5 | 6 | 7 | 8 | 9 | 10 | L1 | L2 |
| | 1730 | | 1731 | N/A | 1867 | 1983 | 2098 | 2214 | 2329 | 2445 | 2560 | 2675 | 2791 | 2906 | N/A | N/A |
| <i>Tight Seat & Back / Removable Upholstery / 500 lb. Weight Capacity</i> | | | | | | | | | | | | | | | | |
| | 1730-R | | 197 | N/A | 439 | 566 | 692 | 819 | 945 | 1072 | 1198 | 1325 | 1451 | 1577 | N/A | N/A |
| <i>Replacement Upholstery Covers</i> | | | | | | | | | | | | | | | | |
| BARIATRIC ARM CHAIR / ACCEPTS SEAT ON RIGHT | | | Overall: 34"w 28"d 34"h | | | Arm: 26"h | | | COM: 4.25 yds. | | | | | | | |
| | | | Seat: 29"w 20"d 19"h | | | Weight: 65 lbs. | | | COL: n/a | | | | | | | |
|  | | | COM | COL | 1 | 2 | 3 | 4 | 5 | 6 | 7 | 8 | 9 | 10 | L1 | L2 |
| | 1730-C | | 1731 | N/A | 1867 | 1983 | 2098 | 2214 | 2329 | 2445 | 2560 | 2675 | 2791 | 2906 | N/A | N/A |
| <i>Tight Seat & Back / Removable Upholstery / 500 lb. Weight Capacity</i> | | | | | | | | | | | | | | | | |
| | 1730-CR | | 197 | N/A | 439 | 566 | 692 | 819 | 945 | 1072 | 1198 | 1325 | 1451 | 1577 | N/A | N/A |
| <i>Replacement Upholstery Covers</i> | | | | | | | | | | | | | | | | |
| BARIATRIC ARM CHAIR / ADD-A-SEAT | | | Overall: 31.5"w 28"d 34"h | | | Arm: 26"h | | | COM: 3.75 yds. | | | | | | | |
| | | | Seat: 29"w 20"d 19"h | | | Weight: 50 lbs. | | | COL: n/a | | | | | | | |
|  | | | COM | COL | 1 | 2 | 3 | 4 | 5 | 6 | 7 | 8 | 9 | 10 | L1 | L2 |
| | 1731 | | 1402 | N/A | 1528 | 1629 | 1730 | 1831 | 1932 | 2033 | 2134 | 2235 | 2336 | 2437 | N/A | N/A |
| <i>Tight Seat & Back / Removable Upholstery / 500 lb. Weight Capacity</i> | | | | | | | | | | | | | | | | |
| | 1731-R | | 162 | N/A | 374 | 485 | 595 | 706 | 817 | 927 | 1038 | 1149 | 1259 | 1370 | N/A | N/A |
| <i>Replacement Upholstery Covers</i> | | | | | | | | | | | | | | | | |
| BARIATRIC ARM CHAIR / ADD-A-SEAT / ACCEPTS SEAT ON RIGHT | | | Overall: 31.5"w 28"d 34"h | | | Arm: 26"h | | | COM: 3.75 yds. | | | | | | | |
| | | | Seat: 29"w 20"d 19"h | | | Weight: 50 lbs. | | | COL: n/a | | | | | | | |
|  | | | COM | COL | 1 | 2 | 3 | 4 | 5 | 6 | 7 | 8 | 9 | 10 | L1 | L2 |
| | 1731-C | | 1402 | N/A | 1528 | 1629 | 1730 | 1831 | 1932 | 2033 | 2134 | 2235 | 2336 | 2437 | N/A | N/A |
| <i>Tight Seat & Back / Removable Upholstery / 500 lb. Weight Capacity</i> | | | | | | | | | | | | | | | | |
| | 1731-CR | | 162 | N/A | 374 | 485 | 595 | 706 | 817 | 927 | 1038 | 1149 | 1259 | 1370 | N/A | N/A |
| <i>Replacement Upholstery Covers</i> | | | | | | | | | | | | | | | | |

DESCRIPTION:

- Upholstery Frames: Steel, Plywood & Hardwood
- Seat: High Density Polyurethane Foam Over Strap Webbing
- Back: High Density Polyurethane Foam Over Sinuous Wire Springs
- Upholstered Covers: Attached w/ Velcro / Removable For Maintenance
- Exposed Wood Legs: Solid Hardwood / Removable For Maintenance
- Antimicrobial Moisture Barrier Fully Encapsulates All Foam Areas
- Leather Upholstery Not Available
- Lifetime Warranty

OPTIONS:

- WAC-2 Solid Wood Arm Caps (Set Of 2)\$143
- UAC-2 Black Urethane Arm Caps (Set Of 2).....\$193
- PM1 Power/Data Module (1-Power / 1-USB 2 Port Simplex Charger)\$859
(Additional Power/Data Modules Available - See Prime Options)
- Tablet Arm / Cup Holder Options (See Facelift Prime Guest/Tandem Options Pages)
- Specify Exposed Wood Finish (See Page 6)
- Biscuit Tufting Available Upon Request (Contact Customer Service For Pricing)

NOTE: All Seating Configurations Are Viewed From Left To Right Facing. Please Attach A Layout Showing Seating Configuration w/ Your Order. Assembled Units Must Be Shipped In Configurations Of 3 Or Less.

TANDEM

ITEM #: SPECIFICATIONS | GRADES | LIST PRICES:

TWO PLACE SOFA

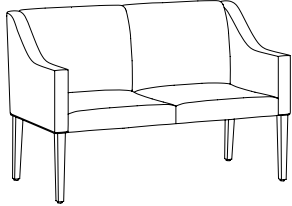

Overall: 52"w 28"d 34"h **Arm:** 26"h **COM:** 5.25 yds.
Seat: 47"w 20"d 19"h **Weight:** 135 lbs. **COL:** n/a

| COM | COL | 1 | 2 | 3 | 4 | 5 | 6 | 7 | 8 | 9 | 10 | L1 | L2 |
|---|-----|------|------|------|------|------|------|------|------|------|------|-----|-----|
| 1748 | N/A | 2401 | 2545 | 2690 | 2834 | 2978 | 3123 | 3267 | 3411 | 3556 | 3700 | N/A | N/A |
| <i>Tight Seat & Back / Removable Upholstery / 750 lb. Weight Capacity</i> | | | | | | | | | | | | | |
| 1748-R | N/A | 604 | 762 | 920 | 1078 | 1236 | 1394 | 1552 | 1710 | 1868 | 2027 | N/A | N/A |
| <i>Replacement Upholstery Covers</i> | | | | | | | | | | | | | |

TWO PLACE SOFA / ACCEPTS SEAT ON RIGHT

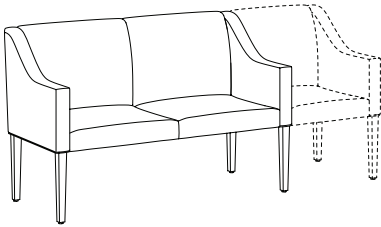

Overall: 52"w 28"d 34"h **Arm:** 26"h **COM:** 5.25 yds.
Seat: 47"w 20"d 19"h **Weight:** 135 lbs. **COL:** n/a

| COM | COL | 1 | 2 | 3 | 4 | 5 | 6 | 7 | 8 | 9 | 10 | L1 | L2 |
|---|-----|------|------|------|------|------|------|------|------|------|------|-----|-----|
| 1748-C | N/A | 2401 | 2545 | 2690 | 2834 | 2978 | 3123 | 3267 | 3411 | 3556 | 3700 | N/A | N/A |
| <i>Tight Seat & Back / Removable Upholstery / 750 lb. Weight Capacity</i> | | | | | | | | | | | | | |
| 1748-CR | N/A | 604 | 762 | 920 | 1078 | 1236 | 1394 | 1552 | 1710 | 1868 | 2027 | N/A | N/A |
| <i>Replacement Upholstery Covers</i> | | | | | | | | | | | | | |

TWO PLACE SOFA / ADD-A-SEAT

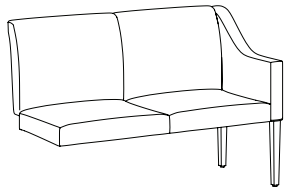

Overall: 49.5"w 28"d 34"h **Arm:** 26"h **COM:** 4.75 yds.
Seat: 47"w 20"d 19"h **Weight:** 120 lbs. **COL:** n/a

| COM | COL | 1 | 2 | 3 | 4 | 5 | 6 | 7 | 8 | 9 | 10 | L1 | L2 |
|---|-----|------|------|------|------|------|------|------|------|------|------|-----|-----|
| 1749 | N/A | 2042 | 2172 | 2302 | 2432 | 2562 | 2692 | 2821 | 2951 | 3081 | 3211 | N/A | N/A |
| <i>Tight Seat & Back / Removable Upholstery / 750 lb. Weight Capacity</i> | | | | | | | | | | | | | |
| 1749-R | N/A | 500 | 642 | 784 | 926 | 1069 | 1211 | 1353 | 1495 | 1638 | 1780 | N/A | N/A |
| <i>Replacement Upholstery Covers</i> | | | | | | | | | | | | | |

TWO PLACE SOFA / ADD-A-SEAT / ACCEPTS SEAT ON RIGHT

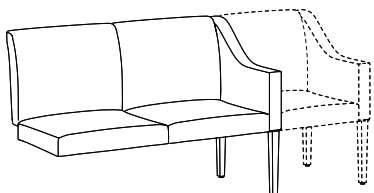

Overall: 49.5"w 28"d 34"h **Arm:** 26"h **COM:** 4.75 yds.
Seat: 47"w 20"d 19"h **Weight:** 120 lbs. **COL:** n/a

| COM | COL | 1 | 2 | 3 | 4 | 5 | 6 | 7 | 8 | 9 | 10 | L1 | L2 |
|---|-----|------|------|------|------|------|------|------|------|------|------|-----|-----|
| 1749-C | N/A | 2042 | 2172 | 2302 | 2432 | 2562 | 2692 | 2821 | 2951 | 3081 | 3211 | N/A | N/A |
| <i>Tight Seat & Back / Removable Upholstery / 750 lb. Weight Capacity</i> | | | | | | | | | | | | | |
| 1749-CR | N/A | 500 | 642 | 784 | 926 | 1069 | 1211 | 1353 | 1495 | 1638 | 1780 | N/A | N/A |
| <i>Replacement Upholstery Covers</i> | | | | | | | | | | | | | |

DESCRIPTION:

- Upholstery Frames: Steel, Plywood & Hardwood
- Seat: High Density Polyurethane Foam Over Strap Webbing
- Upholstered Covers: Attached w/ Velcro / Removable For Maintenance
- Exposed Wood Legs: Solid Hardwood / Removable For Maintenance
- Antimicrobial Moisture Barrier Fully Encapsulates All Foam Areas
- Leather Upholstery Not Available
- Lifetime Warranty

OPTIONS:

- 26HA 26" High Arms.....\$50 Per Arm
 - ARL Brushed Aluminum Round Legs (Set Of 4).....\$353
 - PM1 Power/Data Module (1-Power / 1-USB 2 Port Simplex Charger)\$859
(Additional Power/Data Modules Available - See Prime Options)
- Specify Exposed Wood Finish (See Page 6)
Biscuit Tufting Available Upon Request (Contact Customer Service For Pricing)

NOTE: All Seating Configurations Are Viewed From Left To Right Facing. Please Attach A Layout Showing Seating Configuration w/ Your Order. Assembled Units Must Be Shipped In Configurations Of 3 Or Less.

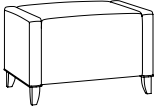
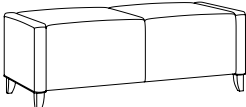
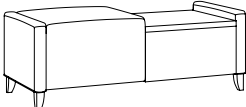
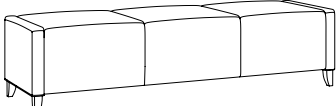
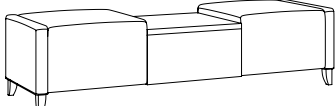
| BENCHES | | ITEM #: | SPECIFICATIONS GRADES LIST PRICES: | | | | | | | | | | | | | |
|---|----------------------------------|---------|--|------------------------|------------|-----------------|-----------------|----------|-----------------------|----------|----------|----------|----------|----------|-----------|-----------|
|  | BENCH / OTTOMAN | | <i>Overall: 28"w 22"d 19"h</i> | | | <i>Arm: n/a</i> | | | <i>COM: 3.25 yds.</i> | | | | | | | |
| | <i>Seat: 23"w 22"d 19"h</i> | | | <i>Weight: 40 lbs.</i> | | | <i>COL: n/a</i> | | | | | | | | | |
| | | | | COM | COL | 1 | 2 | 3 | 4 | 5 | 6 | 7 | 8 | 9 | 10 | L1 |
| | 1761 | | 1097 | N/A | 1210 | 1297 | 1384 | 1470 | 1557 | 1643 | 1730 | 1817 | 1903 | 1990 | N/A | N/A |
| | | | <i>Removable Upholstery / 500 lb. Weight Capacity</i> | | | | | | | | | | | | | |
| | 1761-R | | 169 | N/A | 349 | 444 | 539 | 634 | 729 | 824 | 918 | 1013 | 1108 | 1203 | N/A | N/A |
| | | | <i>Replacement Upholstery Covers</i> | | | | | | | | | | | | | |
|  | TWO SEAT BENCH | | <i>Overall: 52"w 22"d 19"h</i> | | | <i>Arm: n/a</i> | | | <i>COM: 4.5 yds.</i> | | | | | | | |
| | <i>Seat: 47"w 22"d 19"h</i> | | | <i>Weight: 60 lbs.</i> | | | <i>COL: n/a</i> | | | | | | | | | |
| | | | | COM | COL | 1 | 2 | 3 | 4 | 5 | 6 | 7 | 8 | 9 | 10 | L1 |
| | 1762 | | 1703 | N/A | 1856 | 1978 | 2101 | 2224 | 2346 | 2469 | 2592 | 2714 | 2837 | 2960 | N/A | N/A |
| | | | <i>Removable Upholstery / 500 lb. Weight Capacity</i> | | | | | | | | | | | | | |
| | 1762-R | | 218 | N/A | 475 | 609 | 744 | 878 | 1012 | 1147 | 1281 | 1415 | 1550 | 1684 | N/A | N/A |
| | | | <i>Replacement Upholstery Covers</i> | | | | | | | | | | | | | |
|  | SEAT / TABLE BENCH | | <i>Overall: 52"w 22"d 19"h</i> | | | <i>Arm: n/a</i> | | | <i>COM: 3.25 yds.</i> | | | | | | | |
| | <i>Seat: 47"w 22"d 19"h</i> | | | <i>Weight: 70 lbs.</i> | | | <i>COL: n/a</i> | | | | | | | | | |
| | | | | COM | COL | 1 | 2 | 3 | 4 | 5 | 6 | 7 | 8 | 9 | 10 | L1 |
| | 1762-ST | | 1970 | N/A | 2036 | 2123 | 2209 | 2296 | 2382 | 2469 | 2556 | 2642 | 2729 | 2815 | N/A | N/A |
| | | | <i>Removable Upholstery / High Pressure Laminate Top (Square Edge) / 500 lb. Weight Capacity</i> | | | | | | | | | | | | | |
| | 1761-R | | 169 | N/A | 349 | 444 | 539 | 634 | 729 | 824 | 918 | 1013 | 1108 | 1203 | N/A | N/A |
| | | | <i>Replacement Upholstery Covers</i> | | | | | | | | | | | | | |
|  | THREE SEAT BENCH | | <i>Overall: 76"w 22"d 19"h</i> | | | <i>Arm: n/a</i> | | | <i>COM: 6 yds.</i> | | | | | | | |
| | <i>Seat: 71"w 22"d 19"h</i> | | | <i>Weight: 85 lbs.</i> | | | <i>COL: n/a</i> | | | | | | | | | |
| | | | | COM | COL | 1 | 2 | 3 | 4 | 5 | 6 | 7 | 8 | 9 | 10 | L1 |
| | 1763 | | 2242 | N/A | 2452 | 2618 | 2784 | 2950 | 3116 | 3282 | 3448 | 3614 | 3779 | 3945 | N/A | N/A |
| | | | <i>Removable Upholstery / 500 lb. Weight Capacity</i> | | | | | | | | | | | | | |
| | 1763-R | | 267 | N/A | 616 | 798 | 980 | 1162 | 1343 | 1525 | 1707 | 1889 | 2070 | 2252 | N/A | N/A |
| | | | <i>Replacement Upholstery Covers</i> | | | | | | | | | | | | | |
|  | SEAT / TABLE / SEAT BENCH | | <i>Overall: 76"w 22"d 19"h</i> | | | <i>Arm: n/a</i> | | | <i>COM: 4.5 yds.</i> | | | | | | | |
| | <i>Seat: 71"w 22"d 19"h</i> | | | <i>Weight: 95 lbs.</i> | | | <i>COL: n/a</i> | | | | | | | | | |
| | | | | COM | COL | 1 | 2 | 3 | 4 | 5 | 6 | 7 | 8 | 9 | 10 | L1 |
| | 1763-ST | | 2503 | N/A | 2612 | 2735 | 2857 | 2980 | 3103 | 3225 | 3348 | 3471 | 3593 | 3716 | N/A | N/A |
| | | | <i>Removable Upholstery / High Pressure Laminate Top (Square Edge) / 500 lb. Weight Capacity</i> | | | | | | | | | | | | | |
| | 1762-R | | 218 | N/A | 475 | 609 | 744 | 878 | 1012 | 1147 | 1281 | 1415 | 1550 | 1684 | N/A | N/A |
| | | | <i>Replacement Upholstery Covers</i> | | | | | | | | | | | | | |

DESCRIPTION:

- Upholstery Frames: Steel, Plywood & Hardwood
- Seat: High Density Polyurethane Foam Over Strap Webbing
- Upholstered Covers: Attached w/ Velcro / Removable For Maintenance
- Exposed Wood Legs: Solid Hardwood / Removable For Maintenance
- Antimicrobial Moisture Barrier Fully Encapsulates All Foam Areas
- Leather Upholstery Not Available
- Lifetime Warranty

OPTIONS:

- 26HA 26" High Arms\$50 Per Arm
- PM1 Power/Data Module (1-Power / 1-USB 2 Port Simplex Charger)\$859
(Additional Power/Data Modules Available - See Prime Options)
- Specify Exposed Wood Finish (See Page 6)
- Biscuit Tufting Available Upon Request (Contact Customer Service For Pricing)
- Veneer Table Tops (Contact Factory)

NOTE: All Seating Configurations Are Viewed From Left To Right Facing. Please Attach A Layout Showing Seating Configuration w/ Your Order. Assembled Units Must Be Shipped In Configurations Of 3 Or Less.

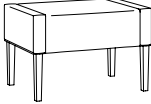
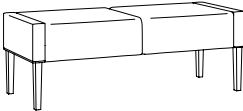
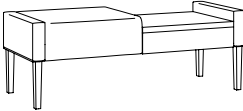
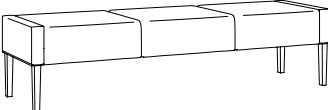
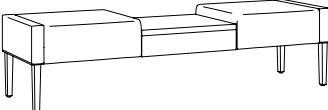
| BENCHES | | ITEM #: | SPECIFICATIONS GRADES LIST PRICES: | | | | | | | | | | | | |
|---|----------------|--|--|------------|----------|------------------------|----------|----------|-----------------------|----------|----------|----------|----------|-----------|-----------|
| BENCH / OTTOMAN  | | | Overall: 28"w 22"d 19"h | | | Arm: n/a | | | COM: 2 yds. | | | | | | |
| | | | Seat: 23"w 22"d 19"h | | | Weight: 40 lbs. | | | COL: n/a | | | | | | |
| | | | COM | COL | 1 | 2 | 3 | 4 | 5 | 6 | 7 | 8 | 9 | 10 | L1 |
| | 1771 | 1032 | N/A | 1077 | 1127 | 1178 | 1228 | 1279 | 1329 | 1380 | 1431 | 1481 | 1532 | N/A | N/A |
| | | <i>Removable Upholstery / 350 lb. Weight Capacity</i> | | | | | | | | | | | | | |
| | 1771-R | 162 | N/A | 263 | 319 | 374 | 429 | 485 | 540 | 595 | 651 | 706 | 761 | N/A | N/A |
| | | <i>Replacement Upholstery Covers</i> | | | | | | | | | | | | | |
| TWO SEAT BENCH  | | | Overall: 52"w 22"d 19"h | | | Arm: n/a | | | COM: 3.25 yds. | | | | | | |
| | | | Seat: 47"w 22"d 19"h | | | Weight: 50 lbs. | | | COL: n/a | | | | | | |
| | | | COM | COL | 1 | 2 | 3 | 4 | 5 | 6 | 7 | 8 | 9 | 10 | L1 |
| | 1772 | 1596 | N/A | 1682 | 1768 | 1855 | 1941 | 2028 | 2115 | 2201 | 2288 | 2374 | 2461 | N/A | N/A |
| | | <i>Removable Upholstery / 750 lb. Weight Capacity</i> | | | | | | | | | | | | | |
| | 1772-R | 211 | N/A | 389 | 484 | 579 | 673 | 768 | 863 | 958 | 1053 | 1148 | 1243 | N/A | N/A |
| | | <i>Replacement Upholstery Covers</i> | | | | | | | | | | | | | |
| SEAT / TABLE BENCH  | | | Overall: 52"w 22"d 19"h | | | Arm: n/a | | | COM: 2 yds. | | | | | | |
| | | | Seat: 47"w 22"d 19"h | | | Weight: 60 lbs. | | | COL: n/a | | | | | | |
| | | | COM | COL | 1 | 2 | 3 | 4 | 5 | 6 | 7 | 8 | 9 | 10 | L1 |
| | 1772-ST | 1783 | N/A | 1787 | 1837 | 1888 | 1939 | 1989 | 2040 | 2090 | 2141 | 2191 | 2242 | N/A | N/A |
| | | <i>Removable Upholstery / High Pressure Laminate Top (Square Edge) / 750 lb. Weight Capacity</i> | | | | | | | | | | | | | |
| | 1771-R | 162 | N/A | 263 | 319 | 374 | 429 | 485 | 540 | 595 | 651 | 706 | 761 | N/A | N/A |
| | | <i>Replacement Upholstery Covers</i> | | | | | | | | | | | | | |
| THREE SEAT BENCH  | | | Overall: 76"w 22"d 19"h | | | Arm: n/a | | | COM: 4 yds. | | | | | | |
| | | | Seat: 71"w 22"d 19"h | | | Weight: 70 lbs. | | | COL: n/a | | | | | | |
| | | | COM | COL | 1 | 2 | 3 | 4 | 5 | 6 | 7 | 8 | 9 | 10 | L1 |
| | 1773 | 2071 | N/A | 2175 | 2283 | 2391 | 2500 | 2608 | 2716 | 2824 | 2932 | 3041 | 3149 | N/A | N/A |
| | | <i>Removable Upholstery / 750 lb. Weight Capacity / 750 lb. Weight Capacity</i> | | | | | | | | | | | | | |
| | 1773-R | 260 | N/A | 483 | 601 | 720 | 839 | 957 | 1076 | 1194 | 1313 | 1431 | 1550 | N/A | N/A |
| | | <i>Replacement Upholstery Covers</i> | | | | | | | | | | | | | |
| SEAT / TABLE / SEAT BENCH  | | | Overall: 76"w 22"d 19"h | | | Arm: n/a | | | COM: 3.25 yds. | | | | | | |
| | | | Seat: 71"w 22"d 19"h | | | Weight: 80 lbs. | | | COL: n/a | | | | | | |
| | | | COM | COL | 1 | 2 | 3 | 4 | 5 | 6 | 7 | 8 | 9 | 10 | L1 |
| | 1773-ST | 2285 | N/A | 2334 | 2421 | 2507 | 2594 | 2680 | 2767 | 2854 | 2940 | 3027 | 3113 | N/A | N/A |
| | | <i>Removable Upholstery / High Pressure Laminate Top (Square Edge) / 750 lb. Weight Capacity</i> | | | | | | | | | | | | | |
| | 1772-R | 211 | N/A | 389 | 484 | 579 | 673 | 768 | 863 | 958 | 1053 | 1148 | 1243 | N/A | N/A |
| | | <i>Replacement Upholstery Covers</i> | | | | | | | | | | | | | |

DESCRIPTION:

- Exposed Frames: Solid Maple, Self Edge, Vertical Direction
- Wilsonart Plastic Laminates Standard. Alternate Selections May Be Specified From Most Major Laminate Manufacturers. (Contact Factory For Availability)
- Lifetime Warranty



OPTIONS:

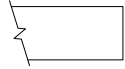

Specify Exposed Wood Finish / Laminate (See Page 6)



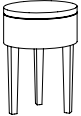
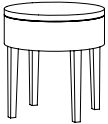
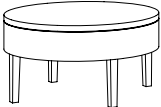



Square Edge Profile Standard

NOTE: All Seating Configurations Are Viewed From Left To Right Facing. Please Attach A Layout Showing Seating Configuration w/ Your Order. Assembled Units Must Be Shipped In Configurations Of 3 Or Less.

| TABLES | ITEM #: | SPECIFICATIONS GRADES LIST PRICES: | | | | | | | | | | | | | |
|---|------------------|---|------------|----------|----------|----------|----------|----------|----------|----------|----------|----------|-----------|-----------|-----------|
| END TABLE / THREE LEG BASE  | | Overall: 16" Diameter 23"h Weight: 20 lbs. | | | | | | | | | | | | | |
| | | COM | COL | 1 | 2 | 3 | 4 | 5 | 6 | 7 | 8 | 9 | 10 | L1 | L2 |
| | 1716D23-L | 897 High Pressure Laminate Face / Self Edge | | | | | | | | | | | | | |
| | 1716D23-C | 1137 Solid Surface Face (Glacier White) / Self Edge | | | | | | | | | | | | | |
| END TABLE  | | Overall: 22" Diameter 23"h Weight: 37 lbs. | | | | | | | | | | | | | |
| | | COM | COL | 1 | 2 | 3 | 4 | 5 | 6 | 7 | 8 | 9 | 10 | L1 | L2 |
| | 1722D23-L | 1043 High Pressure Laminate Face / Self Edge | | | | | | | | | | | | | |
| | 1722D23-C | 1468 Solid Surface Face (Glacier White) / Self Edge | | | | | | | | | | | | | |
| COFFEE TABLE  | | Overall: 36" Diameter 18"h Weight: 40 lbs. | | | | | | | | | | | | | |
| | | COM | COL | 1 | 2 | 3 | 4 | 5 | 6 | 7 | 8 | 9 | 10 | L1 | L2 |
| | 1736D18-L | 2155 High Pressure Laminate Face / Self Edge | | | | | | | | | | | | | |
| | 1736D18-C | 3191 Solid Surface Face (Glacier White) / Self Edge | | | | | | | | | | | | | |
| 18" / 180° ADJUSTABLE TABLE / CONNECTS ANY TANDEM CHAIR  | | Overall: 18" Diameter Weight: 25 lbs. | | | | | | | | | | | | | |
| | | COM | COL | 1 | 2 | 3 | 4 | 5 | 6 | 7 | 8 | 9 | 10 | L1 | L2 |
| | 1718DC-L | 735 High Pressure Laminate Face | | | | | | | | | | | | | |
| | 1718DC-C | 897 Solid Surface Face (Glacier White) / Self Edge | | | | | | | | | | | | | |
| 22" / 180° ADJUSTABLE TABLE / CONNECTS ANY TANDEM CHAIR  | | Overall: 22" Diameter Weight: 25 lbs. | | | | | | | | | | | | | |
| | | COM | COL | 1 | 2 | 3 | 4 | 5 | 6 | 7 | 8 | 9 | 10 | L1 | L2 |
| | 1722DC-L | 747 High Pressure Laminate Face | | | | | | | | | | | | | |
| | 1722DC-C | 1071 Solid Surface Face (Glacier White) / Self Edge | | | | | | | | | | | | | |

| ARM CAPS / LEGS | OPTION #: | SPECIFICATIONS LIST PRICES AVAILABILITY: |
|---|---------------------|--|
| <p>SOLID WOOD ARM CAPS</p>  | <p>WAC-2</p> | <p><i>Overall: 3.25"w 15"d 1.25"h</i></p> <hr/> <p>\$143 <i>(Specify Finish)</i></p> <p><i>Available: Facelift Prime Guest / Tandem Units</i></p> |
| <p>URETHANE ARM CAPS</p>  | <p>UAC-2</p> | <p><i>Overall: 3.25"w 15"d 1.25"h</i></p> <hr/> <p>\$193 <i>(Black Urethane)</i></p> <p><i>Available: Facelift Prime Guest / Tandem Units</i></p> |
| <p>BRUSHED ALUMINUM ROUND LEGS</p>  | <p>ARL</p> | <p><i>Overall: 2" Diameter 5"h</i></p> <hr/> <p>\$353 (Set Of 4) <i>(Brushed Aluminum Finish)</i></p> <p><i>Available: Facelift Prime Low Leg Benches (1761, 1762,1762-ST, 1763, 1763-STs)</i></p> |

| POWER / ARMS / COVERS | OPTION #: | SPECIFICATIONS LIST PRICES AVAILABILITY: |
|--|---|---|
| <p>POWER / DATA MODULE</p>  <p>PM1 Power / Data Module</p>  <p>PM2 Power Module</p>  <p>USB-1 Dual Charging USB</p> | <p>PM1</p> <p>PM2</p> <p>USB-1</p> | <p>PM1 Overall: 5.25"w 1.25"d 4.25"h PM2 Overall: 2"w 2"d .125"h USB-1 Overall: 2"w 2"d .125"h</p> <p>\$859 Power/Data Module (1-Power / 1-USB 2 Port Simplex Charger Standard) <i>Vertical / Horizontal Mount Power Module. Price Varies By Socket. Contact Customer Service For Quote. (Additional Colors Available)</i></p> <p>\$238 Power Module (1-Power) <i>Spill-Proof Technology / Multiple Finish Options / Storm Color Standard (Specify Left or Right Facing)</i></p> <p>\$238 Dual Charging USB (2 Port Simplex Charger Standard) <i>Spill-Proof Technology / 2 Amps Per Port / Multiple Finish Options / Storm Color Standard (Specify Left or Right Facing)</i></p> <p>Available: Facelift Prime Guest / Tandem</p> |
| <p>26" HIGH ARMS</p>  | <p>26HA</p> | <p>Overall: 2.75"w 22"d 26"h</p> <p>\$50 (Per Arm) <i>26" High Arms For Benches (Specify Fabric)</i></p> <p>Available: Facelift Prime Benches</p> |
| <p>CONTRASTING COVERS</p>  | <p>CC</p> | <p>Overall: N/A</p> <p>\$129 <i>NOTE: If Two Or More Upholsteries Or Leathers Are Used On Any Piece Of Furniture, Then A Contrast Charge Will Apply Per Order. When Using Trinity Upholstery, The Higher Priced Upholstery Grade Will Be Used In Pricing, Unless It's Trinity Leather With Fabric Contrast Welt, Or COM With Trinity Contrast Welt, Then Contact Customer Service For Pricing.</i></p> <p>Available: Facelift Prime Collection</p> |

Facelift Revival

LOUNGE / BENCHES

Effective: March 1, 2025

T R I N I T Y

Date:

Page:

Modification:

Description:

DESCRIPTION:

- Upholstery Frames: Steel, Plywood & Hardwood
- Seat: High Density Polyurethane Foam Over Strap Webbing
- Back: High Density Polyurethane Foam Over Sinuous Wire Springs
- Upholstered Covers: Attached w/ Velcro / Removable For Maintenance
- Antimicrobial Moisture Barrier Fully Encapsulates All Foam Areas
- Double Needle Stitching Standard (Welting Optional - No Charge)
- Exposed Wood Legs: Solid Hardwood / Removable For Maintenance
- Leather Upholstery Not Available
- Lifetime Warranty

OPTIONS:

- ARL Brushed Aluminum Round Legs (Set Of 4).....\$353
- PM1 Power/Data Module (1-Power / 1-USB 2 Port Simplex Charger)\$859
(Additional Power/Data Modules Available - See Revival Options)

Feather Down & Polyester Pillows Available (See Page 5)
Specify Exposed Wood Finish (See Page 6)

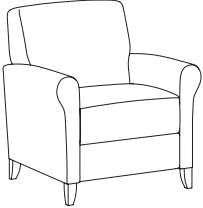
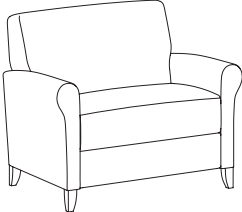
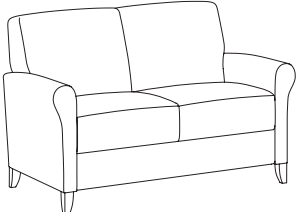
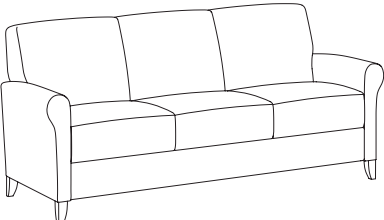
| LOUNGE | | ITEM #: | SPECIFICATIONS GRADES LIST PRICES: | | | | | | | | | | | | | |
|---|---|----------------|--|------------|----------|---|----------|----------|--|----------|----------|----------|----------|-----------|-----------|-----------|
|  | LOUNGE CHAIR / FULLY UPHOLSTERED | 1801 | Overall: 31"w 32"d 34"h Seat: 21"w 20"d 18.5"h | | | Arm: 24"h Weight: 82 lbs. | | | COM: 4.75 yds. COL: n/a | | | | | | | |
| | | | COM | COL | 1 | 2 | 3 | 4 | 5 | 6 | 7 | 8 | 9 | 10 | L1 | L2 |
| | | | 1562 | N/A | 1674 | 1827 | 1957 | 2087 | 2217 | 2347 | 2476 | 2606 | 2736 | 2866 | N/A | N/A |
| | | | <i>Tight Seat & Back / Removable Upholstery / 500 lb. Weight Capacity</i> | | | | | | | | | | | | | |
| | | 1801-R | 261 | N/A | 531 | 674 | 816 | 958 | 1100 | 1243 | 1385 | 1527 | 1669 | 1812 | N/A | N/A |
| <i>Replacement Upholstery Covers</i> | | | | | | | | | | | | | | | | |
|  | BARIATRIC LOUNGE CHAIR / FULLY UPHOLSTERED | 1801-X | Overall: 39.5"w 32"d 34"h Seat: 29.5"w 20"d 18.5"h | | | Arm: 24"h Weight: 95 lbs. | | | COM: 5.25 yds. COL: n/a | | | | | | | |
| | | | COM | COL | 1 | 2 | 3 | 4 | 5 | 6 | 7 | 8 | 9 | 10 | L1 | L2 |
| | | | 1807 | N/A | 1997 | 2142 | 2286 | 2430 | 2575 | 2719 | 2863 | 3008 | 3152 | 3296 | N/A | N/A |
| | | | <i>Tight Seat & Back / Removable Upholstery / 1000 lb. Weight Capacity</i> | | | | | | | | | | | | | |
| | | 1801-XR | 261 | N/A | 563 | 721 | 879 | 1037 | 1195 | 1353 | 1511 | 1669 | 1828 | 1986 | N/A | N/A |
| <i>Replacement Upholstery Covers</i> | | | | | | | | | | | | | | | | |
|  | TWO PLACE SOFA / FULLY UPHOLSTERED | 1802 | Overall: 57"w 32"d 34"h Seat: 47.5"w 20"d 18.5"h | | | Arm: 24"h Weight: 120 lbs. | | | COM: 6.75 yds. COL: n/a | | | | | | | |
| | | | COM | COL | 1 | 2 | 3 | 4 | 5 | 6 | 7 | 8 | 9 | 10 | L1 | L2 |
| | | | 2434 | N/A | 2666 | 2833 | 2970 | 3157 | 3345 | 3532 | 3720 | 3908 | 4095 | 4283 | N/A | N/A |
| | | | <i>Tight Seat & Back / Removable Upholstery / 1000 lb. Weight Capacity</i> | | | | | | | | | | | | | |
| | | 1802-R | 385 | N/A | 775 | 980 | 1185 | 1391 | 1596 | 1802 | 2007 | 2213 | 2418 | 2624 | N/A | N/A |
| <i>Replacement Upholstery Covers</i> | | | | | | | | | | | | | | | | |
|  | THREE PLACE SOFA / FULLY UPHOLSTERED | 1803 | Overall: 80"w 32"d 34"h Seat: 70.5"w 20"d 18.5"h | | | Arm: 24"h Weight: 155 lbs. | | | COM: 8.75 yds. COL: n/a | | | | | | | |
| | | | COM | COL | 1 | 2 | 3 | 4 | 5 | 6 | 7 | 8 | 9 | 10 | L1 | L2 |
| | | | 3229 | N/A | 3544 | 3789 | 4035 | 4280 | 4525 | 4771 | 5016 | 5261 | 5507 | 5752 | N/A | N/A |
| | | | <i>Tight Seat & Back / Removable Upholstery / 1000 lb. Weight Capacity</i> | | | | | | | | | | | | | |
| | | 1803-R | 485 | N/A | 996 | 1264 | 1533 | 1802 | 2071 | 2339 | 2608 | 2877 | 3145 | 3414 | N/A | N/A |
| <i>Replacement Upholstery Covers</i> | | | | | | | | | | | | | | | | |



DESCRIPTION:

- Upholstery Frames: Steel, Plywood & Hardwood
- Seat: High Density Polyurethane Foam Over Strap Webbing
- Back: High Density Polyurethane Foam Over Sinuous Wire Springs
- Upholstered Covers: Attached w/ Velcro / Removable For Maintenance
- Antimicrobial Moisture Barrier Fully Encapsulates All Foam Areas
- Double Needle Stitching Standard (Welting Optional - No Charge)
- Exposed Wood Legs: Solid Hardwood / Removable For Maintenance
- Leather Upholstery Not Available
- Lifetime Warranty

OPTIONS:

- ARL Brushed Aluminum Round Legs (Set Of 4).....\$353
- PM1 Power/Data Module (1-Power / 1-USB 2 Port Simplex Charger)\$859
(Additional Power/Data Modules Available - See Revival Options)
- 24HA 24" High Arms For Bench\$80 Per Arm

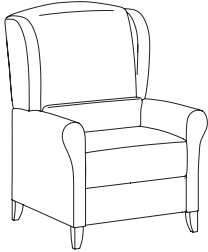
Feather Down & Polyester Pillows Available (See Page 5)
Specify Exposed Wood Finish (See Page 6)

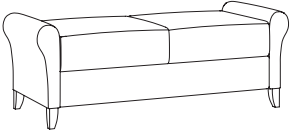
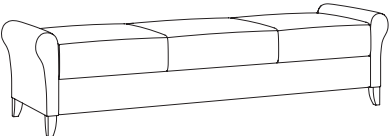
| LOUNGE / BENCHES | | ITEM #: | SPECIFICATIONS GRADES LIST PRICES: | | | | | | | | | | | | | |
|---|---------------|---------|--|------------|----------|-------------------------|----------|----------|-----------------------|----------|----------|----------|----------|-----------|-----------|-----------|
|  | | | Overall: 31"w 32"d 42"h | | | Arm: 24"h | | | COM: 6.25 yds. | | | | | | | |
| | | | Seat: 21"w 20"d 18.5"h | | | Weight: 115 lbs. | | | COL: n/a | | | | | | | |
| | | | COM | COL | 1 | 2 | 3 | 4 | 5 | 6 | 7 | 8 | 9 | 10 | L1 | L2 |
| | 1815 | | 1746 | N/A | 1997 | 2170 | 2343 | 2516 | 2690 | 2863 | 3036 | 3209 | 3382 | 3556 | N/A | N/A |
| | | | <i>Tight Seat & Back / Adjustable Semi-Attached Pillow-Lumbar / Removable Upholstery / 500 lb. Weight Capacity</i> | | | | | | | | | | | | | |
| | 1815-R | | 313 | N/A | 660 | 842 | 1023 | 1205 | 1387 | 1569 | 1750 | 1932 | 2114 | 2296 | N/A | N/A |
| | | | <i>Replacement Upholstery Covers</i> | | | | | | | | | | | | | |
|  | | | Overall: 22"w 18"d 15"h | | | Arm: n/a | | | COM: 1.75 yds. | | | | | | | |
| | | | Seat: 15"h | | | Weight: 18 lbs. | | | COL: n/a | | | | | | | |
| | | | COM | COL | 1 | 2 | 3 | 4 | 5 | 6 | 7 | 8 | 9 | 10 | L1 | L2 |
| | 1816 | | 554 | N/A | 611 | 654 | 697 | 741 | 784 | 827 | 871 | 914 | 957 | 1000 | N/A | N/A |
| | | | <i>Tight Seat / Removable Upholstery / 500 lb. Weight Capacity</i> | | | | | | | | | | | | | |
| | 1816-R | | 121 | N/A | 209 | 257 | 304 | 351 | 399 | 446 | 494 | 541 | 589 | 636 | N/A | N/A |
| | | | <i>Replacement Upholstery Covers</i> | | | | | | | | | | | | | |
|  | | | Overall: 56"w 23"d 20"h | | | Arm: 20"h | | | COM: 4 yds. | | | | | | | |
| | | | Seat: 18"h | | | Weight: 90 lbs. | | | COL: n/a | | | | | | | |
| | | | COM | COL | 1 | 2 | 3 | 4 | 5 | 6 | 7 | 8 | 9 | 10 | L1 | L2 |
| | 1818 | | 1639 | N/A | 1766 | 1874 | 1982 | 2091 | 2199 | 2307 | 2415 | 2524 | 2632 | 2740 | N/A | N/A |
| | | | <i>Tight Seat & Back / Removable Upholstery / 1000 lb. Weight Capacity</i> | | | | | | | | | | | | | |
| | 1818-R | | 208 | N/A | 434 | 553 | 671 | 790 | 908 | 1027 | 1145 | 1264 | 1383 | 1501 | N/A | N/A |
| | | | <i>Replacement Upholstery Covers</i> | | | | | | | | | | | | | |
|  | | | Overall: 81"w 23"d 20"h | | | Arm: 20"h | | | COM: 5.25 yds. | | | | | | | |
| | | | Seat: 18"h | | | Weight: 115 lbs. | | | COL: n/a | | | | | | | |
| | | | COM | COL | 1 | 2 | 3 | 4 | 5 | 6 | 7 | 8 | 9 | 10 | L1 | L2 |
| | 1819 | | 2176 | N/A | 2346 | 2491 | 2635 | 2779 | 2924 | 3068 | 3212 | 3356 | 3501 | 3645 | N/A | N/A |
| | | | <i>Tight Seat & Back / Removable Upholstery / 1000 lb. Weight Capacity</i> | | | | | | | | | | | | | |
| | 1819-R | | 251 | N/A | 554 | 712 | 870 | 1028 | 1186 | 1344 | 1502 | 1660 | 1818 | 1976 | N/A | N/A |
| | | | <i>Replacement Upholstery Covers</i> | | | | | | | | | | | | | |

| LEGS / ARMS / POWER / COVERS | OPTION #: | SPECIFICATIONS LIST PRICES AVAILABILITY: |
|---|---|--|
| <p>BRUSHED ALUMINUM ROUND LEGS</p>  | <p>ARL</p> | <p>Overall: 2" Diameter 5"h</p> <hr/> <p>\$353 (Set Of 4) <i>(Brushed Aluminum Finish)</i></p> <p>Available: <i>Facelift Revival Collection</i></p> |
| <p>24" HIGH ARMS</p>  | <p>24HA</p> | <p>Overall: 5"w 23"d 24"h</p> <hr/> <p>\$80 (Per Arm) <i>24" High Arms For Bench (Specify Fabric)</i></p> <p>Available: <i>Facelift Revival Benches</i></p> |
| <p>POWER / DATA MODULE</p>  <p>PM1 Power / Data Module</p>  <p>PM2 Power Module</p>  <p>USB-1 Dual Charging USB</p> | <p>PM1</p> <p>PM2</p> <p>USB-1</p> | <p>PM1 Overall: 5.25"w 1.25"d 4.25"h PM2 Overall: 2"w 2"d .125"h USB-1 Overall: 2"w 2"d .125"h</p> <hr/> <p>\$859 Power/Data Module (1-Power / 1-USB 2 Port Simplex Charger Standard) <i>Vertical / Horizontal Mount Power Module. Price Varies By Socket. Contact Customer Service For Quote. (Additional Colors Available)</i></p> <p>\$238 Power Module (1-Power) <i>Spill-Proof Technology / Multiple Finish Options / Storm Color Standard (Specify Left or Right Facing)</i></p> <p>\$238 Dual Charging USB (2 Port Simplex Charger Standard) <i>Spill-Proof Technology / 2 Amps Per Port / Multiple Finish Options / Storm Color Standard (Specify Left or Right Facing)</i></p> <p>Available: <i>Facelift Revival Collection</i></p> |
| <p>CONTRASTING COVERS</p>  | <p>CC</p> | <p>Overall: <i>N/A</i></p> <hr/> <p>\$129</p> <p><i>NOTE: If Two Or More Upholsteries Or Leathers Are Used On Any Piece Of Furniture, Then A Contrast Charge Will Apply Per Order. When Using Trinity Upholstery, The Higher Priced Upholstery Grade Will Be Used In Pricing, Unless It's Trinity Leather With Fabric Contrast Welt, Or COM With Trinity Contrast Welt, Then Contact Customer Service For Pricing.</i></p> <p>Available: <i>Facelift Revival Collection</i></p> |

Facelift Revival

HEALTHCARE MOTION

Effective: March 1, 2025

T R I N I T Y

Date:

Page:

Modification:

Description:

DESCRIPTION:





- Upholstery Frames: Steel, Plywood & Hardwood
- Seat: High Density Polyurethane Foam Over Sheet Webbing
- Back: High Density Polyurethane Foam Over Polypropylene Webbing
- Upholstered Covers: Attached w/ Velcro / Removable For Maintenance
- Removable Bolster Pillow For 1804 / 1805 (5" Diameter)
- Antimicrobial Moisture Barrier Fully Encapsulates All Foam Areas
- Double Needle Stitching Standard (Welting Optional - No Charge)
- Metal To Metal Connections For All Hardware Assembly
- Leather Upholstery Not Available
- Lifetime Warranty

OPTIONS:

- LC Locking Casters (Set Of 2)\$44
- NLC Non-Locking Casters (Set Of 2).....\$37
- 3LC 3" Locking Casters - #1806 Model Only (Set Of 2).....\$218
- PM1 Power/Data Module (1-Power / 1-USB 2 Port Simplex Charger)\$859
(Additional Power/Data Modules Available - See Revival Options)

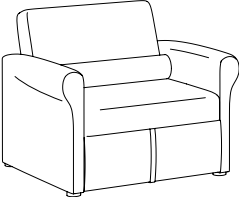
Feather Down & Polyester Pillows Available (See Page 5)
Specify Exposed Wood Finish (See Page 6)

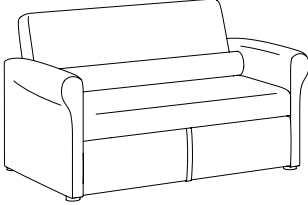
SLEEPOVER UNITS

| ITEM #: | SPECIFICATIONS GRADES LIST PRICES: | | | | | | | | | | | | | |
|---|---|------------|----------|----------|--|----------|----------|----------|---|----------|---|-----------|-----------|-----------|
| LOUNGE CHAIR / FULLY UPHOLSTERED   | Overall: 40"w 34.5"d 33"h Sleep Area: 28"w 80"d | | | | Overall Length: 84"d Seat: 28"w 23"d 17.5"h | | | | Arm: 24"h Weight: 175 lbs. | | COM: 6.5 yds. COL: n/a | | | |
| | COM | COL | 1 | 2 | 3 | 4 | 5 | 6 | 7 | 8 | 9 | 10 | L1 | L2 |
| | 1804 | N/A | 4767 | 4947 | 5128 | 5308 | 5488 | 5669 | 5849 | 6030 | 6210 | 6390 | N/A | N/A |
| | <i>Tight Seat & Back / Removable Upholstery / 500 lb. Weight Capacity</i> | | | | | | | | | | | | | |
| 1804-R | 302 | N/A | 681 | 879 | 1076 | 1274 | 1471 | 1669 | 1867 | 2064 | 2262 | 2459 | N/A | N/A |
| | <i>Replacement Upholstery Covers</i> | | | | | | | | | | | | | |
| TWO PLACE SOFA / FULLY UPHOLSTERED   | Overall: 60"w 34.5"d 33"h Sleep Area: 48"w 80"d | | | | Overall Length: 84"d Seat: 48"w 23"d 17.5"h | | | | Arm: 24"h Weight: 225 lbs. | | COM: 9 yds. COL: n/a | | | |
| | COM | COL | 1 | 2 | 3 | 4 | 5 | 6 | 7 | 8 | 9 | 10 | L1 | L2 |
| | 1805 | N/A | 6092 | 6345 | 6597 | 6850 | 7102 | 7355 | 7608 | 7860 | 8113 | 8365 | N/A | N/A |
| | <i>Tight Seat & Back / Removable Upholstery / 750 lb. Weight Capacity</i> | | | | | | | | | | | | | |
| 1805-R | 360 | N/A | 894 | 1170 | 1447 | 1723 | 2000 | 2277 | 2553 | 2830 | 3107 | 3383 | N/A | N/A |
| | <i>Replacement Upholstery Covers</i> | | | | | | | | | | | | | |

FOUR POSITION ADJUSTMENT FOR 1804 / 1805

 See Replay Healthcare Motion And Evolve Healthcare Motion For Additional Sleeper Units.



1) Closed Position



2) Ottoman Position



3) Chaise Position



4) Full-Recline Position
Overall Length - 84"d

BACK-FLIP SLEEPER SOFA

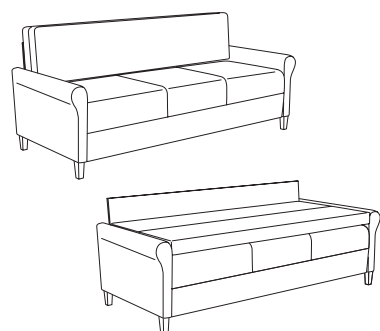

| | | | | | | | | | | | | | | |
|----------------------------------|---|------------|----------|----------|---|----------|----------|----------|---|----------|----------|-----------|-----------|-----------|
| 1806 1806-R | Overall: 80"w 36"d 36"h Sleep Area: 70"w 31"d 20"h | | | | Arm: 24.5"h Weight: 235 lbs. | | | | COM: 12.75 yds. COL: n/a | | | | | |
| | COM | COL | 1 | 2 | 3 | 4 | 5 | 6 | 7 | 8 | 9 | 10 | L1 | L2 |
| | N/A | N/A | 4729 | 5090 | 5451 | 5812 | 6173 | 6533 | 6894 | 7255 | 7616 | 7977 | N/A | N/A |
| | <i>Tight Seat & Back / Removable Upholstery / 1000 lbs. Weight Capacity</i> | | | | | | | | | | | | | |
| | N/A | N/A | 1911 | 2306 | 2701 | 3096 | 3491 | 3887 | 4282 | 4677 | 5072 | 5467 | N/A | N/A |
| | <i>Replacement Upholstery Covers</i> | | | | | | | | | | | | | |







DESCRIPTION:

- Upholstery Frames: Steel, Plywood & Hardwood
- Seat: High Density Polyurethane Foam Over Sheet Webbing
- Back: High Density Polyurethane Foam Over Polypropylene Webbing
- Upholstered Covers: Attached w/ Velcro / Removable For Maintenance
- Antimicrobial Moisture Barrier Fully Encapsulates All Foam Areas
- Double Needle Stitching Standard (Wetling Optional - No Charge)
- Exposed Wood Legs: Solid Hardwood / Removable For Maintenance
- Leather Upholstery Not Available
- Lifetime Warranty

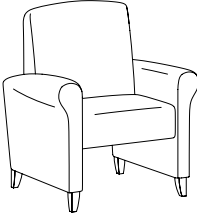
OPTIONS:

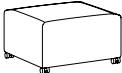
- ARL Brushed Aluminum Round Legs (Set Of 4).....\$353
- LC Locking Casters For 1809 Ottoman (Set Of 2)\$44
- WR Wood Ring Base - Replaces Metal Base On 1810-G/1810-SG\$224
- PM1 Power/Data Module (1-Power / 1-USB 2 Port Simplex Charger)\$859
(Additional Power/Data Modules Available - See Revival Options)

Feather Down & Polyester Pillows Available (See Page 5)
Specify Exposed Wood Finish (See Page 6)

| PATIENT CHAIR / GLIDER | | ITEM #: | SPECIFICATIONS GRADES LIST PRICES: | | | | | | | | | | | | | |
|---|--|----------------|--|------------|----------|-------------------------|----------|----------|-----------------------|----------|----------|----------|----------|-----------|-----------|-----------|
|  | | 1808 | Overall: 32.5"w 35.5"d 38"h | | | Arm: 24"h | | | COM: 5.25 yds. | | | | | | | |
| | | | Seat: 21"w 20"d 18"h | | | Weight: 63 lbs. | | | COL: n/a | | | | | | | |
| | | | COM | COL | 1 | 2 | 3 | 4 | 5 | 6 | 7 | 8 | 9 | 10 | L1 | L2 |
| | | | 1721 | N/A | 1961 | 2128 | 2295 | 2462 | 2629 | 2796 | 2963 | 3130 | 3297 | 3464 | N/A | N/A |
| | | | <i>Tight Seat & Back / Removable Upholstery / 500 lb. Weight Capacity</i> | | | | | | | | | | | | | |
| | | 1808-R | 224 | N/A | 528 | 686 | 844 | 1003 | 1161 | 1319 | 1477 | 1635 | 1793 | 1951 | N/A | N/A |
| | | | <i>Replacement Upholstery Covers</i> | | | | | | | | | | | | | |
|  | | | | | | | | | | | | | | | | |
|  | | 1809 | Overall: 18"w 18"d 11"h | | | Arm: n/a | | | COM: 1 yd. | | | | | | | |
| | | | Seat: n/a | | | Weight: 25 lbs. | | | COL: n/a | | | | | | | |
| | | | COM | COL | 1 | 2 | 3 | 4 | 5 | 6 | 7 | 8 | 9 | 10 | L1 | L2 |
| | | | 386 | N/A | 409 | 430 | 452 | 474 | 495 | 517 | 539 | 560 | 582 | 603 | N/A | N/A |
| | | | <i>Removable Upholstery / 350 lb. Weight Capacity</i> | | | | | | | | | | | | | |
| | | 1809-R | 94 | N/A | 136 | 160 | 183 | 207 | 231 | 254 | 278 | 302 | 326 | 349 | N/A | N/A |
| | | | <i>Replacement Upholstery Covers</i> | | | | | | | | | | | | | |
|  | | | | | | | | | | | | | | | | |
|  | | 1810-G | Overall: 32"w 32"d 35"h | | | Arm: 24"h | | | COM: 4.75 yds. | | | | | | | |
| | | | Seat: 21"w 20"d 18"h | | | Weight: 115 lbs. | | | COL: n/a | | | | | | | |
| | | | COM | COL | 1 | 2 | 3 | 4 | 5 | 6 | 7 | 8 | 9 | 10 | L1 | L2 |
| | | | 1866 | N/A | 2024 | 2154 | 2284 | 2413 | 2543 | 2673 | 2803 | 2933 | 3063 | 3193 | N/A | N/A |
| | | | <i>Circular Metal Base / Tight Seat & Back / Removable Upholstery / 500 lb. Weight Capacity</i> | | | | | | | | | | | | | |
| | | 1810-SG | 2049 | N/A | 2151 | 2281 | 2411 | 2540 | 2670 | 2800 | 2930 | 3060 | 3190 | 3320 | N/A | N/A |
| | | | <i>Swivel Glider w/ Circular Metal Base / Tight Seat & Back / Removable Upholstery / 500 lb. Weight Capacity</i> | | | | | | | | | | | | | |
| | | 1810-GR | 261 | N/A | 531 | 674 | 816 | 958 | 1100 | 1243 | 1385 | 1527 | 1669 | 1812 | N/A | N/A |
| | | | <i>Replacement Upholstery Covers</i> | | | | | | | | | | | | | |
|  | | | | | | | | | | | | | | | | |
|  | | | <p>See Replay Healthcare Motion And Evolve Healthcare Motion For Additional Patient Chairs & Gliders.</p> | | | | | | | | | | | | | |

DESCRIPTION:







- Upholstery Frames: Steel, Plywood & Hardwood
- Seat: High Density Polyurethane Foam Over Sheet Webbing
- Back: High Density Polyurethane Foam Over Sinuous Wire Springs
- Upholstered Covers: Attached w/ Velcro / Removable For Maintenance
- Antimicrobial Moisture Barrier Fully Encapsulates All Foam Areas
- Double Needle Stitching Standard (Welting Optional - No Charge)
- Leather Upholstery Not Available
- Lifetime Warranty

OPTIONS:

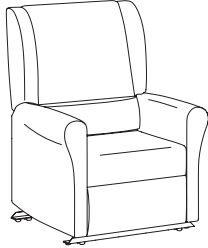
(See Facelift Revival Healthcare Options Pages)

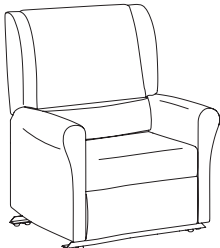
| | | |
|------|------------------------|--------|
| ER-1 | Electric Recline | \$1054 |
| BB | Battery Backup | \$548 |
| HM | Heat & Massage | \$1498 |
| H | Heat Only | \$1142 |

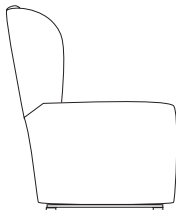
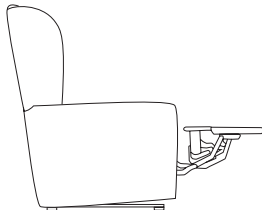
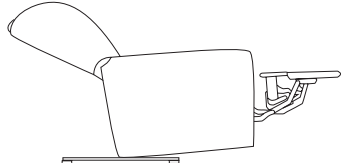
Feather Down & Polyester Pillows Available (See Page 5)
Specify Exposed Wood Finish (See Page 6)

| WALLSAVER | | ITEM #: | SPECIFICATIONS GRADES LIST PRICES: | | | | | | | | | | | | | |
|---|---|---|---|------------|--|---|----------|---|--|----------|----------|----------|----------|-----------|-----------|-----------|
|  | WALLSAVER RECLINER / FULLY UPHOLSTERED | | Overall: 31.5"w 34"d 42.25"h Seat: 21"w 21.75"d 18"h | | | Arm: 23"h Weight: 115 lbs. | | | COM: 6.25 yds. COL: n/a | | | | | | | |
| | | | COM | COL | 1 | 2 | 3 | 4 | 5 | 6 | 7 | 8 | 9 | 10 | L1 | L2 |
| | 1811 | | 2354 | N/A | 2627 | 2827 | 3028 | 3228 | 3429 | 3629 | 3829 | 4030 | 4230 | 4431 | N/A | N/A |
| | | <i>Tight Seat & Back / Removable Upholstery / Adjustable Semi-Attached Pillow-Lumbar / 6" Wall Proximity / 350 lb. Weight Capacity</i> | | | | | | | | | | | | | | |
| | 1811-R | 294 | N/A | 657 | 847 | 1037 | 1226 | 1416 | 1606 | 1795 | 1985 | 2175 | 2364 | N/A | N/A | |
| | | <i>Replacement Upholstery Covers</i> | | | | | | | | | | | | | | |
| | |  | | | | | | | | | | | | | | |
|  | BARIATRIC WALLSAVER RECLINER / FULLY UPHOLSTERED | | Overall: 36.5"w 34"d 42.25"h Seat: 26"w 21.75"d 18"h | | | Arm: 23"h Weight: 125 lbs. | | | COM: 6.75 yds. COL: n/a | | | | | | | |
| | | | COM | COL | 1 | 2 | 3 | 4 | 5 | 6 | 7 | 8 | 9 | 10 | L1 | L2 |
| | 1811-X | | 2439 | N/A | 2740 | 2957 | 3175 | 3392 | 3609 | 3826 | 4043 | 4260 | 4477 | 4695 | N/A | N/A |
| | | <i>Tight Seat & Back / Removable Upholstery / Adjustable Semi-Attached Pillow-Lumbar / 6" Wall Proximity / 500 lb. Weight Capacity</i> | | | | | | | | | | | | | | |
| | 1811-XR | 301 | N/A | 664 | 853 | 1043 | 1233 | 1422 | 1612 | 1802 | 1991 | 2181 | 2371 | N/A | N/A | |
| | | <i>Replacement Upholstery Covers</i> | | | | | | | | | | | | | | |
| | |  | | | | | | | | | | | | | | |
| | |  | | |  | | |  | | | | | | | | |
| | | Upright Position 34"D | | | Extended Footrest Position 57.5"D | | | Full Recline Position 67"D | | | | | | | | |
| | |  See Replay Healthcare Motion And Evolve Healthcare Motion For Additional WallSaver Recliners. | | | | | | | | | | | | | | |

DESCRIPTION:

- Upholstery Frames: Steel, Plywood & Hardwood
- Seat: High Density Polyurethane Foam Over Sheet Webbing
- Back: High Density Polyurethane Foam Over Sinuous Wire Springs
- Upholstered Covers: Attached w/ Velcro / Removable For Maintenance
- Antimicrobial Moisture Barrier Fully Encapsulates All Foam Areas
- Double Needle Stitching Standard (Wetling Optional - No Charge)
- Dual-Wheel Casters: (2) Front Locking/Swivel & (2) Rear Non-Locking/Non-Swivel (1514)
- (2) Drop Down Side Trays Mounted To Black Metal Tubing (1514)
- Exposed Wood Legs (1812): Solid Hardwood / Removable For Maintenance
- Leather Upholstery Not Available
- Lifetime Warranty

OPTIONS:

(See Facelift Revival Healthcare Options Pages)
 Feather Down & Polyester Pillows Available (See Page 5)

INFUSION / STAND-UP RECLINER

ITEM #:

SPECIFICATIONS | GRADES | LIST PRICES:

INFUSION WALLSAVER RECLINER / FULLY UPHOLSTERED



Optional Central Braking Available

Healthcare Motion

See Replay & Evolve Healthcare Motion For Additional Infusion Wallsaver Recliners.

| Overall: 31.25"w 34"d 46"h | Arm: 27"h | COM: 6.5 yds. | | | | | | | | | | | | | | | |
|---|------------------|---------------|--------|------|-----|------|------|------|------|------|------|------|------|------|------|-----|-----|
| Seat: 21"w 20.5"d 19"h | Weight: 130 lbs. | COL: n/a | COM | COL | 1 | 2 | 3 | 4 | 5 | 6 | 7 | 8 | 9 | 10 | L1 | L2 | |
| | | | 1814 | 3124 | N/A | 3335 | 3526 | 3717 | 3908 | 4099 | 4290 | 4480 | 4671 | 4862 | 5053 | N/A | N/A |
| <i>Tight Seat & Back / Removable Upholstery / 350 lb. Weight Capacity</i> | | | | | | | | | | | | | | | | | |
| | | | 1814-R | 323 | N/A | 638 | 804 | 969 | 1135 | 1301 | 1467 | 1633 | 1799 | 1965 | 2131 | N/A | N/A |
| <i>Replacement Upholstery Covers</i> | | | | | | | | | | | | | | | | | |

***NOTE: ELECTRIC OPTION NOT AVAILABLE ON INFUSION RECLINERS IN COMBINATION WITH CASTERS.**



Upright Position
32"D



Extended Footrest Position
52"D



Full Redine Position
64.5"D

ELECTRIC STAND-UP RECLINER / FULLY UPHOLSTERED

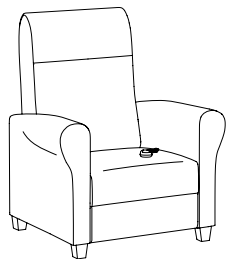

Healthcare Motion

See Replay Healthcare Motion For Additional Electric Stand-Up Recliner.

| Overall: 35"w 35"d 42"h | Arm: 24.5"h | COM: 5.25 yds. | | | | | | | | | | | | | | | |
|---|------------------|----------------|--------|------|-----|------|------|------|------|------|------|------|------|------|------|-----|-----|
| Seat: 21.5"w 21.75"d 18"h | Weight: 145 lbs. | COL: n/a | COM | COL | 1 | 2 | 3 | 4 | 5 | 6 | 7 | 8 | 9 | 10 | L1 | L2 | |
| | | | 1812 | 3485 | N/A | 3629 | 3796 | 3963 | 4131 | 4298 | 4465 | 4632 | 4799 | 4966 | 5133 | N/A | N/A |
| <i>Tight Seat & Back / Removable Upholstery / 350 lb. Weight Capacity</i> | | | | | | | | | | | | | | | | | |
| | | | 1812-R | 309 | N/A | 608 | 766 | 924 | 1082 | 1240 | 1398 | 1556 | 1714 | 1872 | 2030 | N/A | N/A |
| <i>Replacement Upholstery Covers</i> | | | | | | | | | | | | | | | | | |

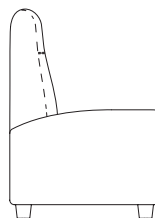

Upright Position
35"D

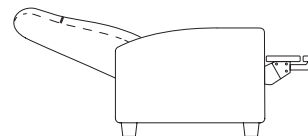

Full Recline Position
66"D

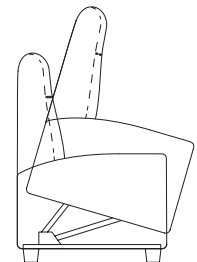

Stand-Up Position
59"H





DESCRIPTION:

- Upholstery Frames: Steel, Plywood & Hardwood
- Seat: High Density Polyurethane Foam Over Sheet Webbing
- Back: High Density Polyurethane Foam Over Sinuous Wire Springs
- Upholstered Covers: Attached w/ Velcro / Removable For Maintenance
- Antimicrobial Moisture Barrier Fully Encapsulates All Foam Areas
- Double Needle Stitching Standard (Welting Optional - No Charge)
- Rotational & Directional Locking Casters (Rear)
- Leather Upholstery Not Available
- Lifetime Warranty

OPTIONS:

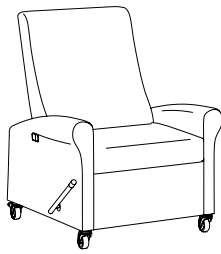
Layflat Medical Recliner Options (See Revival Healthcare Options Pages)

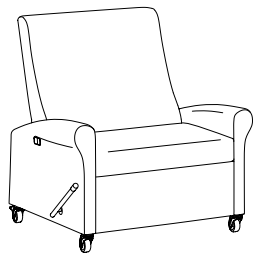
Feather Down & Polyester Pillows Available (See Page 5)

| LAYFLAT MEDICAL RECLINER | ITEM #: | SPECIFICATIONS GRADES LIST PRICES: | | | | | | | | | | | | | |
|---|---|---|------------|----------|-------------------------|----------|----------|-----------------------|----------|----------|----------|----------|-----------|-----------|-----------|
|  | LAYFLAT / TRENDELENBURG RECLINER | Overall: 35"w 38.5"d 45"h | | | Arm: 28"h | | | COM: 5.5 yds. | | | | | | | |
| | | Seat: 24"w 20"d 20"h | | | Weight: 160 lbs. | | | COL: n/a | | | | | | | |
| | | COM | COL | 1 | 2 | 3 | 4 | 5 | 6 | 7 | 8 | 9 | 10 | L1 | L2 |
| | 1813-L | 3669 | N/A | 3819 | 3995 | 4170 | 4346 | 4521 | 4696 | 4872 | 5047 | 5223 | 5398 | N/A | N/A |
| | | <i>Layflat / Tight Seat & Back / Removable Upholstery / 500 lb. Weight Capacity</i> | | | | | | | | | | | | | |
| 1813-T | 3810 | N/A | 3953 | 4128 | 4304 | 4479 | 4655 | 4830 | 5005 | 5181 | 5356 | 5532 | N/A | N/A | |
| | | <i>Trendelenburg / Tight Seat & Back / Removable Upholstery / 500 lb. Weight Capacity</i> | | | | | | | | | | | | | |
| 1813-R | 303 | N/A | 619 | 785 | 951 | 1117 | 1282 | 1448 | 1614 | 1780 | 1946 | 2112 | N/A | N/A | |
| | | <i>Replacement Upholstery Covers</i> | | | | | | | | | | | | | |
|  | | | | | | | | | | | | | | | |
|  | BARIATRIC LAYFLAT / TRENDELENBURG RECLINER | Overall: 40"w 38.5"d 45"h | | | Arm: 28"h | | | COM: 6.25 yds. | | | | | | | |
| | | Seat: 29"w 20"d 20"h | | | Weight: 185 lbs. | | | COL: n/a | | | | | | | |
| | | COM | COL | 1 | 2 | 3 | 4 | 5 | 6 | 7 | 8 | 9 | 10 | L1 | L2 |
| | 1813-XL | 3861 | N/A | 4051 | 4252 | 4452 | 4653 | 4853 | 5054 | 5254 | 5454 | 5655 | 5855 | N/A | N/A |
| | | <i>Layflat / Tight Seat & Back / Removable Upholstery / 600 lb. Weight Capacity</i> | | | | | | | | | | | | | |
| 1813-XT | 4038 | N/A | 4218 | 4419 | 4619 | 4820 | 5020 | 5221 | 5421 | 5622 | 5822 | 6022 | N/A | N/A | |
| | | <i>Trendelenburg / Tight Seat & Back / Removable Upholstery / 600 lb. Weight Capacity</i> | | | | | | | | | | | | | |
| 1813-XR | 355 | N/A | 668 | 834 | 1000 | 1166 | 1332 | 1498 | 1664 | 1830 | 1996 | 2162 | N/A | N/A | |
| | | <i>Replacement Upholstery Covers</i> | | | | | | | | | | | | | |
|  | | | | | | | | | | | | | | | |

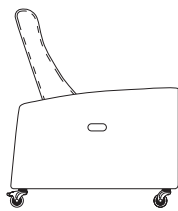

Upright Position
38.5"D

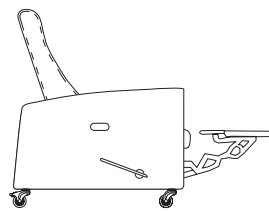

Extended Footrest Position
57.5"D

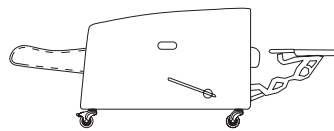

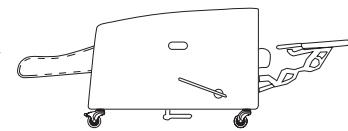

Layflat Position
73.75"D









Trendelenburg Position
74.75"D

 See *Replay Healthcare Motion* (Page 176)
And *Evolve Healthcare Motion* (Page 290)
For Additional Layflat Medical Recliners.

| CASTERS / POWER | OPTION #: | SPECIFICATIONS LIST PRICES AVAILABILITY: |
|---|--------------|--|
| LOCKING / NON-LOCKING CASTERS | | |
| <i>Overall: 1.875"w 2.25"d 1.5"h (Locking) / 1.875"w 1.625"d 1.5"h (Non-Locking)</i> | | |
|  <p>Locking Casters</p>  <p>Non-Locking Casters</p> | LC | <p>\$44 (Set Of Two) <i>Locking Casters (Black Finish / Specify Location)</i></p> |
| | NLC | <p>\$37 (Set Of Two) <i>Non-Locking Casters (Black Finish / Specify Location)</i></p> |
| <i>Available: Facelift 2 Revival Sleepover Lounge</i> | | |
| WALLSAVER - LOCKING / NON-LOCKING CASTERS | | |
| <i>Overall: 2.5"w 4"d 3.5"h (Locking) / 2.5"w 3.25"d 3.5"h (Non-Locking)</i> | | |
|  <p>Locking Casters</p>  <p>Non-Locking Casters</p> | WLC | <p>\$199 List (Set Of Two) <i>Locking Swivel Casters (Gray Finish / Back Location)</i></p> |
| | WNLC | <p>\$185 List (Set Of Two) <i>Non-Locking / Non-Swivel Casters (Gray Finish / Front Location)</i></p> |
| <i>Note: Wallsaver Locking / Non-Locking Casters Cannot Be Used In Combination With Electric Recline.</i> | | |
| <i>Available: Facelift Wallsaver Recliners (1511 / 1811 / 1855 & Bariatric Versions)</i> | | |
| MEDICAL LOCKING / NON-LOCKING CASTERS | | |
| <i>Overall: 2.25"w 5"d 5.25"h (Locking) / 2"w 3.75"d 5.25"h (Non-Locking)</i> | | |
|  <p>Locking Casters</p>  <p>Non-Locking Casters</p> | MLC | <p>\$194 (Set Of Two) <i>Locking Casters - Motion & Direction (Gray Finish / Specify Location)</i></p> |
| | MNLC | <p>\$224 (Set Of Two) <i>Non-Locking Casters - Single Direction (Gray Finish / Specify Location)</i></p> |
| <i>Available: Facelift 2 Revival Electric Standup Recliner</i> | | |
| POWER / DATA MODULE | | |
| <i>PM1 Overall: 5.25"w 1.25"d 4.25"h PM2 Overall: 2"w 2"d .125"h USB-1 Overall: 2"w 2"d .125"h</i> | | |
|  <p>PM1 Power / Data Module</p>  <p>PM2 Power Module</p>  <p>USB-1 Dual Charging USB</p> | PM1 | <p>\$859 Power/Data Module (1-Power / 1-USB 2 Port Simplex Charger Standard) <i>Vertical / Horizontal Mount Power Module. Price Varies By Socket. Contact Customer Service For Quote. (Additional Colors Available)</i></p> |
| | PM2 | <p>\$238 Power Module (1-Power) <i>Spill-Proof Technology / Multiple Finish Options / Storm Color Standard (Specify Left or Right Facing)</i></p> |
| | USB-1 | <p>\$238 Dual Charging USB (2 Port Simplex Charger Standard) <i>Spill-Proof Technology / 2 Amps Per Port / Multiple Finish Options / Storm Color Standard (Specify Left or Right Facing)</i></p> |
| <i>Available: Facelift Revival Healthcare Collection (1804, 1805, 1806, 1808)</i> | | |

| BRAKE / LEGS / ELECTRIC / PUSH BAR | OPTION #: | SPECIFICATIONS LIST PRICES AVAILABILITY: |
|--|--|--|
| CENTRAL BRAKING | | |
| <i>Overall: 7.5"w 2"d .5"h</i> | | |
|  | CB-1 | \$508 (Set Of 1) <i>(Gray Plastic Brake w/ Lock & Unlock Pedals)</i> Available: <i>Facelift Revival Wallsaver & Infusion Wallsaver Recliners (1811, 1814)</i> |
| | CB-2 | \$510 (Set Of 1) <i>(Gray Plastic Brake w/ Lock & Unlock Pedals)</i> Available: <i>Facelift Revival Layflat (1813 L/T)</i> |
| ALUMINUM ROUND LEGS | | |
| <i>Overall: 2" Diameter 5"h</i> | | |
|  | ARL | \$353 (Set Of 4) <i>(Brushed Aluminum Finish)</i> Available: <i>Facelift 2 Revival Asynchronous Patient Chair (1808 Model)</i> |
| | | |
| ELECTRIC RECLINE / BATTERY BACKUP / HEAT / MASSAGE | | |
| <i>Overall: N/A</i> | | |
|  <p>ER-1 Electric Recline (Wallsaver Model)</p> <p>ER-2/ER-3 Electric Recline (Layflat Model)</p> <p>HM Heat & Massage (All Recliner Models)</p> <p>H Heat (All Recliner Models)</p> | ER-1 | \$1054 Electric Recline <i>Replaces Manual Mechanism On Any Wallsaver Model - Surface Mounts On Inside Arm (Specify Left Or Right Facing)</i> <i>*NOTE: ELECTRIC OPTION NOT AVAILABLE ON INFUSION RECLINERS IN COMBINATION WITH CASTERS.</i> |
| | ER-2 | \$1087 Electric Recline <i>Replaces Manual Mechanism On Any Layflat Model - Surface Mounts On Inside Arm (Specify Left Or Right Facing)</i> |
| | ER-3 | \$1149 Electric Recline <i>Replaces Manual Mechanism On Any Trendelenburg Layflat Model - Surface Mounts On Inside Arm (Specify Left Or Right Facing)</i> |
| | BB | \$548 Battery Backup <i>Allows Any Wallsaver, Layflat, Or Standup Electric Recliner To Be Cordless - Surface Mounts On Inside Arm (Specify Left Or Right Facing)</i> |
| | HM | \$1498 Heat & Massage <i>Add Heat & Massage To Any Wallsaver, Layflat, Or Standup Electric Recliner - Surface Mounts On Inside Arm (Specify Left Or Right Facing)</i> |
| H | \$1142 Heat <i>Add Heat Only To Any Wallsaver, Layflat, Or Standup Electric Recliner - Surface Mounts On Inside Arm (Specify Left Or Right Facing)</i> Available: <i>Facelift Revival Recliners</i> | |
| PUSH BAR | | |
| <i>Overall: 18.5"w 3.5"d 1"h</i> | | |
|  | PB | \$267 <i>(Black Finish)</i> Available: <i>Facelift 2 Revival Medical Recliners</i> |
| | | |

| I.V. / SIDE TRAY / BAG HOLDER / RESTRAINT BUCKLE / FOOTREST | OPTION #: | SPECIFICATIONS LIST PRICES AVAILABILITY: |
|---|------------------------------|--|
| <p>I.V. POLE</p>  | <p>IV</p> | <p>Overall: 10"w 2.5"d 39.5" / 69.75"h</p> <hr/> <p>\$489 <i>Height Adjustable I.V. Pole (Chrome & Black Finish / Specify Left Or Right Facing Location)</i></p> <p>Available: <i>Facelift 2 Revival Medical Recliners</i></p> |
| <p>SIDE TRAY</p>   | <p>ST-1 ST-2 WST</p> | <p>Overall: 12.75"w 10"d 4"h (Small Side Tray) / 17"w 10"d 4"h (Large Side Tray)</p> <hr/> <p>\$368 <i>Drop-Down Side Tray (Small Side Tray)</i></p> <p>\$415 <i>Drop-Down Side Tray (Large Side Tray)</i></p> <p>Available: <i>Facelift 2 Revival Medical Recliners</i> <i>Note: If A Medical Recliner With A Manual Mechanism Is Selected, The Standard Side Tray Location Will Be Front Right Facing</i></p> <p>\$598 <i>Drop-Down Side Tray (Large Side Tray) NOTE: Attaches To Metal Tubing</i></p> <p>Available: <i>Facelift Revival Wallsaver Recliners With Casters Option (1811)</i></p> |
| <p>BAG HOLDER / PERSONAL RESTRAINT BUCKLE</p>  | <p>BH RB</p> | <p>Overall: 2.19"w .38"d 2.56"h</p> <hr/> <p>\$86 <i>Bag Holder (Brushed Finish / Specify Left Or Right Facing Location)</i></p> <p>\$133 (Set Of 2) <i>Personal Restraint Buckle (Brushed Finish)</i></p> <p>Available: <i>Facelift 2 Revival Medical Recliners</i></p> |
| <p>FOOTREST</p>  | <p>FR</p> | <p>Overall: 16"w 8"d .1875"h</p> <hr/> <p>\$408 <i>(Black Finish)</i></p> <p>Available: <i>Facelift 2 Revival Medical Recliners</i></p> |

| OXYGEN TANK HOLDER / WOOD RING BASE / COVERS | OPTION #: | SPECIFICATIONS LIST PRICES AVAILABILITY: |
|--|---|--|
| <p>OXYGEN TANK HOLDER</p>  | <p>OH</p> <p>Overall: 4.75" Diameter 9.75"h</p> <p>\$247 <i>Black Metal Oxygen Tank Holder Holds a 4.375" Diameter Oxygen Tank (Not Included) (Specify Left Or Right Facing Location)</i></p> <p>Available: <i>Facelift 3 Revival Medical Recliners</i></p> | |
| <p>LOUNGE GLIDER WOOD RING BASE</p>  | <p>WR</p> <p>Overall: 22"dia. 3"h</p> <p>\$224 <i>Wood Ring Base replaces circular metal base (1810-G) or swivel glider w/ circular metal base (1810-SG).</i></p> <p><i>Specify Exposed Wood Finish. (See Page 6)</i></p> <p>Available: <i>Facelift Revival Lounge Glider</i></p> | |
| <p>CONTRASTING COVERS</p>  | <p>CC</p> <p>Overall: N/A</p> <p>\$129 <i>NOTE: If Two Or More Upholsteries Or Leathers Are Used On Any Piece Of Furniture, Then A Contrast Charge Will Apply Per Order. When Using Trinity Upholstery, The Higher Priced Upholstery Grade Will Be Used In Pricing, Unless It's Trinity Leather With Fabric Contrast Welt, Or COM With Trinity Contrast Welt, Then Contact Customer Service For Pricing.</i></p> <p>Available: <i>Facelift 2 Revival Healthcare Motion</i></p> | |

Facelift Evolve

GUEST / TANDEM / TABLES

Effective: March 1, 2025

T R I N I T Y

Date:

Page:

Modification:

Description:

DESCRIPTION:

- Upholstery Frames: Steel, Plywood & Hardwood
- Seat: High Density Polyurethane Foam Over Strap Webbing
- Back: High Density Polyurethane Foam Over Plywood
- Upholstered Covers: Attached w/ Velcro / Removable For Maintenance
- Exposed Wood Legs: Solid Hardwood / Removable For Maintenance / Wallsaver Legs
- Antimicrobial Moisture Barrier Fully Encapsulates All Foam Areas
- Leather Upholstery Not Available
- Adjustable Height Leveling Glides Standard
- Lifetime Warranty

OPTIONS:

Closed Arm Panels (See 1800-PL / 1800-PR Item #'s)..... CALL FOR PRICING
Specify Exposed Wood Finish (See Page 6)

NOTE: All Seating Configurations Are Viewed From Left To Right Facing. Please Attach A Layout Showing Seating Configuration w/ Your Order. Assembled Units Must Be Shipped In Configurations Of 3 Or Less.

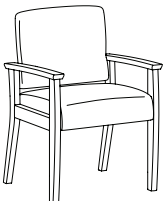
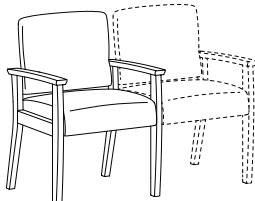
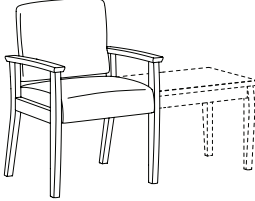
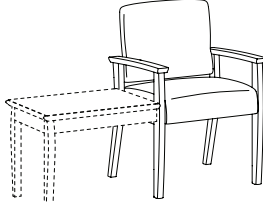
| GUEST / TANDEM | | ITEM #: | SPECIFICATIONS GRADES LIST PRICES: | | | | | | | | | | | | | |
|---|---|---|---|------------|--|----------|--|----------|----------|----------|----------|----------|----------|-----------|-----------|-----------|
|  | ARM SIDE CHAIR / WOOD ARMS | | Overall: 23.5"w 24"d 34"h Seat: 20"w 19"d 18.5"h | | Arm: 25"h Weight: 45 lbs. | | COM: 1.75 yds. COL: n/a | | | | | | | | | |
| | | | COM | COL | 1 | 2 | 3 | 4 | 5 | 6 | 7 | 8 | 9 | 10 | L1 | L2 |
| | 1820 | | 1220 | N/A | 1240 | 1283 | 1327 | 1370 | 1413 | 1457 | 1500 | 1543 | 1587 | 1630 | N/A | N/A |
| | | <i>Open Back / Tight Seat & Back / Removable Upholstery / 350 lb. Weight Capacity</i> | | | | | | | | | | | | | | |
| | 1820-R | 150 | N/A | 237 | 284 | 332 | 379 | 426 | 474 | 521 | 569 | 616 | 664 | N/A | N/A | |
| | | <i>Replacement Upholstery Covers</i> | | | | | | | | | | | | | | |
|  | ARM CHAIR / WOOD ARMS / ACCEPTS SEAT ON RIGHT | | Overall: 23.5"w 24"d 34"h Seat: 20"w 19"d 18.5"h | | Arm: 25"h Weight: 45 lbs. | | COM: 1.75 yds. COL: n/a | | | | | | | | | |
| | | | COM | COL | 1 | 2 | 3 | 4 | 5 | 6 | 7 | 8 | 9 | 10 | L1 | L2 |
| | 1820-C | | 1220 | N/A | 1240 | 1283 | 1327 | 1370 | 1413 | 1457 | 1500 | 1543 | 1587 | 1630 | N/A | N/A |
| | | <i>Open Back / Tight Seat & Back / Removable Upholstery / 350 lb. Weight Capacity</i> | | | | | | | | | | | | | | |
| | 1820-R | 150 | N/A | 237 | 284 | 332 | 379 | 426 | 474 | 521 | 569 | 616 | 664 | N/A | N/A | |
| | | <i>Replacement Upholstery Covers</i> | | | | | | | | | | | | | | |
|  | ARM CHAIR / WOOD ARMS / ACCEPTS TABLE ON RIGHT | | Overall: 23.5"w 24"d 34"h Seat: 20"w 19"d 18.5"h | | Arm: 25"h Weight: 45 lbs. | | COM: 1.75 yds. COL: n/a | | | | | | | | | |
| | | | COM | COL | 1 | 2 | 3 | 4 | 5 | 6 | 7 | 8 | 9 | 10 | L1 | L2 |
| | 1820-T | | 1220 | N/A | 1240 | 1283 | 1327 | 1370 | 1413 | 1457 | 1500 | 1543 | 1587 | 1630 | N/A | N/A |
| | | <i>Open Back / Tight Seat & Back / Removable Upholstery / 350 lb. Weight Capacity</i> | | | | | | | | | | | | | | |
| | 1820-R | 150 | N/A | 237 | 284 | 332 | 379 | 426 | 474 | 521 | 569 | 616 | 664 | N/A | N/A | |
| | | <i>Replacement Upholstery Covers</i> | | | | | | | | | | | | | | |
|  | ARM CHAIR / WOOD ARMS / ACCEPTS TABLE ON LEFT | | Overall: 23.5"w 24"d 34"h Seat: 20"w 19"d 18.5"h | | Arm: 25"h Weight: 45 lbs. | | COM: 1.75 yds. COL: n/a | | | | | | | | | |
| | | | COM | COL | 1 | 2 | 3 | 4 | 5 | 6 | 7 | 8 | 9 | 10 | L1 | L2 |
| | 1820-LT | | 1220 | N/A | 1240 | 1283 | 1327 | 1370 | 1413 | 1457 | 1500 | 1543 | 1587 | 1630 | N/A | N/A |
| | | <i>Open Back / Tight Seat & Back / Removable Upholstery / 350 lb. Weight Capacity</i> | | | | | | | | | | | | | | |
| | 1820-R | 150 | N/A | 237 | 284 | 332 | 379 | 426 | 474 | 521 | 569 | 616 | 664 | N/A | N/A | |
| | | <i>Replacement Upholstery Covers</i> | | | | | | | | | | | | | | |

DESCRIPTION:

- Upholstery Frames: Steel, Plywood & Hardwood
- Seat: High Density Polyurethane Foam Over Strap Webbing
- Back: High Density Polyurethane Foam Over Plywood
- Upholstered Covers: Attached w/ Velcro / Removable For Maintenance
- Exposed Wood Legs: Solid Hardwood / Removable For Maintenance / Wallsaver Legs
- Antimicrobial Moisture Barrier Fully Encapsulates All Foam Areas
- Leather Upholstery Not Available
- Adjustable Height Leveling Glides Standard
- Lifetime Warranty

OPTIONS:

Closed Arm Panels (See 1800-PL / 1800-PR Item #'s)..... CALL FOR PRICING
Specify Exposed Wood Finish (See Page 6)

NOTE: All Seating Configurations Are Viewed From Left To Right Facing. Please Attach A Layout Showing Seating Configuration w/ Your Order. Assembled Units Must Be Shipped In Configurations Of 3 Or Less.

TANDEM

ITEM #:

SPECIFICATIONS | GRADES | LIST PRICES:

ARM CHAIR / WOOD ARMS / ACCEPTS
TABLE ON LEFT / SEAT ON RIGHT

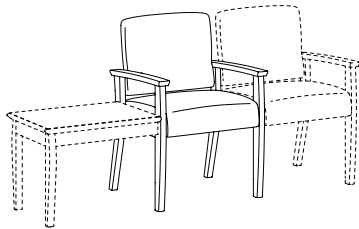

1820-TC

1820-R

Overall: 23.5"w 24"d 34"h **Arm:** 25"h **COM:** 1.75 yds.
Seat: 20"w 19"d 18.5"h **Weight:** 45 lbs. **COL:** n/a

| COM | COL | 1 | 2 | 3 | 4 | 5 | 6 | 7 | 8 | 9 | 10 | L1 | L2 |
|---|-----|------|------|------|------|------|------|------|------|------|------|-----|-----|
| 1220 | N/A | 1240 | 1283 | 1327 | 1370 | 1413 | 1457 | 1500 | 1543 | 1587 | 1630 | N/A | N/A |
| <i>Open Back / Tight Seat & Back / Removable Upholstery / 350 lb. Weight Capacity</i> | | | | | | | | | | | | | |
| 150 | N/A | 237 | 284 | 332 | 379 | 426 | 474 | 521 | 569 | 616 | 664 | N/A | N/A |
| <i>Replacement Upholstery Covers</i> | | | | | | | | | | | | | |

ARM CHAIR / WOOD ARMS /
ACCEPTS TABLE ON LEFT / RIGHT

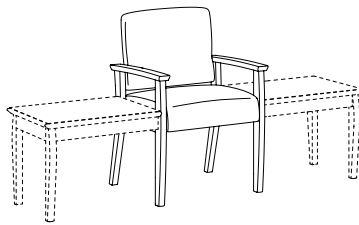

1820-TT

1820-R

Overall: 23.5"w 24"d 34"h **Arm:** 25"h **COM:** 1.75 yds.
Seat: 20"w 19"d 18.5"h **Weight:** 45 lbs. **COL:** n/a

| COM | COL | 1 | 2 | 3 | 4 | 5 | 6 | 7 | 8 | 9 | 10 | L1 | L2 |
|---|-----|------|------|------|------|------|------|------|------|------|------|-----|-----|
| 1220 | N/A | 1240 | 1283 | 1327 | 1370 | 1413 | 1457 | 1500 | 1543 | 1587 | 1630 | N/A | N/A |
| <i>Open Back / Tight Seat & Back / Removable Upholstery / 350 lb. Weight Capacity</i> | | | | | | | | | | | | | |
| 150 | N/A | 237 | 284 | 332 | 379 | 426 | 474 | 521 | 569 | 616 | 664 | N/A | N/A |
| <i>Replacement Upholstery Covers</i> | | | | | | | | | | | | | |

DESCRIPTION:

- Upholstery Frames: Steel, Plywood & Hardwood
- Seat: High Density Polyurethane Foam Over Strap Webbing
- Back: High Density Polyurethane Foam Over Plywood
- Upholstered Covers: Attached w/ Velcro / Removable For Maintenance
- Exposed Wood Legs: Solid Hardwood / Removable For Maintenance / Wallsaver Legs
- Antimicrobial Moisture Barrier Fully Encapsulates All Foam Areas
- Leather Upholstery Not Available
- Adjustable Height Leveling Glides Standard
- Lifetime Warranty

OPTIONS:

Closed Arm Panels (See 1800-PL / 1800-PR Item #'s)..... CALL FOR PRICING
Specify Exposed Wood Finish (See Page 6)

NOTE: All Seating Configurations Are Viewed From Left To Right Facing. Please Attach A Layout Showing Seating Configuration w/ Your Order. Assembled Units Must Be Shipped In Configurations Of 3 Or Less.

TANDEM

ITEM #: SPECIFICATIONS | GRADES | LIST PRICES:

ADD-A-SEAT / WOOD ARMS

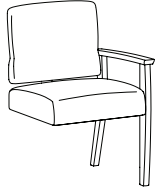

| | | | | | | | | | | | | | |
|---|------------|-----------------------------------|----------|------------------------|----------|-----------------------|----------|----------|----------|----------|-----------|-----------|-----------|
| | | Overall: 21.75"w 24"d 34"h | | Arm: 25"h | | COM: 1.75 yds. | | | | | | | |
| | | Seat: 20"w 19"d 18.5"h | | Weight: 40 lbs. | | COL: n/a | | | | | | | |
| COM | COL | 1 | 2 | 3 | 4 | 5 | 6 | 7 | 8 | 9 | 10 | L1 | L2 |
| 1821 | N/A | 1004 | 1047 | 1090 | 1133 | 1177 | 1220 | 1263 | 1307 | 1350 | 1393 | N/A | N/A |
| <i>Open Back / Tight Seat & Back / Removable Upholstery / 350 lb. Weight Capacity</i> | | | | | | | | | | | | | |
| 1820-R | N/A | 237 | 284 | 332 | 379 | 426 | 474 | 521 | 569 | 616 | 664 | N/A | N/A |
| <i>Replacement Upholstery Covers</i> | | | | | | | | | | | | | |

ADD-A-SEAT / WOOD ARMS / ACCEPTS SEAT ON RIGHT

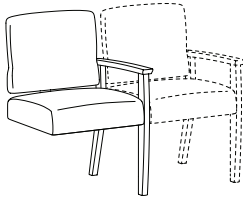

| | | | | | | | | | | | | | |
|---|------------|-----------------------------------|----------|------------------------|----------|-----------------------|----------|----------|----------|----------|-----------|-----------|-----------|
| | | Overall: 21.75"w 24"d 34"h | | Arm: 25"h | | COM: 1.75 yds. | | | | | | | |
| | | Seat: 20"w 19"d 18.5"h | | Weight: 40 lbs. | | COL: n/a | | | | | | | |
| COM | COL | 1 | 2 | 3 | 4 | 5 | 6 | 7 | 8 | 9 | 10 | L1 | L2 |
| 1821-C | N/A | 1004 | 1047 | 1090 | 1133 | 1177 | 1220 | 1263 | 1307 | 1350 | 1393 | N/A | N/A |
| <i>Open Back / Tight Seat & Back / Removable Upholstery / 350 lb. Weight Capacity</i> | | | | | | | | | | | | | |
| 1820-R | N/A | 237 | 284 | 332 | 379 | 426 | 474 | 521 | 569 | 616 | 664 | N/A | N/A |
| <i>Replacement Upholstery Covers</i> | | | | | | | | | | | | | |

ADD-A-SEAT / WOOD ARMS / ACCEPTS TABLE ON RIGHT

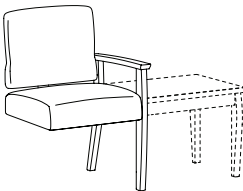

| | | | | | | | | | | | | | |
|---|------------|-----------------------------------|----------|------------------------|----------|-----------------------|----------|----------|----------|----------|-----------|-----------|-----------|
| | | Overall: 21.75"w 24"d 34"h | | Arm: 25"h | | COM: 1.75 yds. | | | | | | | |
| | | Seat: 20"w 19"d 18.5"h | | Weight: 40 lbs. | | COL: n/a | | | | | | | |
| COM | COL | 1 | 2 | 3 | 4 | 5 | 6 | 7 | 8 | 9 | 10 | L1 | L2 |
| 1821-T | N/A | 1004 | 1047 | 1090 | 1133 | 1177 | 1220 | 1263 | 1307 | 1350 | 1393 | N/A | N/A |
| <i>Open Back / Tight Seat & Back / Removable Upholstery / 350 lb. Weight Capacity</i> | | | | | | | | | | | | | |
| 1820-R | N/A | 237 | 284 | 332 | 379 | 426 | 474 | 521 | 569 | 616 | 664 | N/A | N/A |
| <i>Replacement Upholstery Covers</i> | | | | | | | | | | | | | |

DESCRIPTION:

- Upholstery Frames: Steel, Plywood & Hardwood
- Seat: High Density Polyurethane Foam Over Strap Webbing
- Back: High Density Polyurethane Foam Over Plywood
- Upholstered Covers: Attached w/ Velcro / Removable For Maintenance
- Exposed Wood Legs: Solid Hardwood / Removable For Maintenance / Wallsaver Legs
- Antimicrobial Moisture Barrier Fully Encapsulates All Foam Areas
- Leather Upholstery Not Available
- Adjustable Height Leveling Glides Standard
- Lifetime Warranty

OPTIONS:

- EPAC-1 Black Polyester Arm Caps (Set Of 2).....\$374
- Closed Arm Panels (See 1800-PL / 1800-PR Item #'s)..... CALL FOR PRICING

Specify Exposed Wood Finish (See Page 6)

NOTE: All Seating Configurations Are Viewed From Left To Right Facing. Please Attach A Layout Showing Seating Configuration w/ Your Order. Assembled Units Must Be Shipped In Configurations Of 3 Or Less.

GUEST / TANDEM

ITEM #:

SPECIFICATIONS | GRADES | LIST PRICES:

ARM SIDE CHAIR / URETHANE ARMS

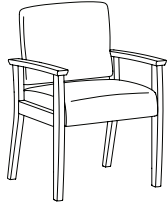

Overall: 23.5"w 24"d 34"h **Arm:** 25"h **COM:** 1.75 yds.
Seat: 20"w 19"d 18.5"h **Weight:** 45 lbs. **COL:** n/a

| COM | COL | 1 | 2 | 3 | 4 | 5 | 6 | 7 | 8 | 9 | 10 | L1 | L2 |
|---|-----|------|------|------|------|------|------|------|------|------|------|-----|-----|
| 1822 | N/A | 1269 | 1301 | 1344 | 1387 | 1431 | 1474 | 1517 | 1561 | 1604 | 1647 | N/A | N/A |
| <i>Open Back / Tight Seat & Back / Removable Upholstery / 350 lb. Weight Capacity</i> | | | | | | | | | | | | | |
| 1820-R | N/A | 237 | 284 | 332 | 379 | 426 | 474 | 521 | 569 | 616 | 664 | N/A | N/A |
| <i>Replacement Upholstery Covers</i> | | | | | | | | | | | | | |

ARM CHAIR / URETHANE ARMS / ACCEPTS SEAT ON RIGHT

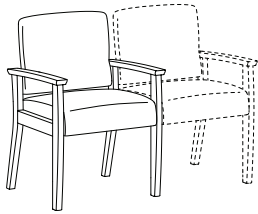

Overall: 23.5"w 24"d 34"h **Arm:** 25"h **COM:** 1.75 yds.
Seat: 20"w 19"d 18.5"h **Weight:** 45 lbs. **COL:** n/a

| COM | COL | 1 | 2 | 3 | 4 | 5 | 6 | 7 | 8 | 9 | 10 | L1 | L2 |
|---|-----|------|------|------|------|------|------|------|------|------|------|-----|-----|
| 1822-C | N/A | 1269 | 1301 | 1344 | 1387 | 1431 | 1474 | 1517 | 1561 | 1604 | 1647 | N/A | N/A |
| <i>Open Back / Tight Seat & Back / Removable Upholstery / 350 lb. Weight Capacity</i> | | | | | | | | | | | | | |
| 1820-R | N/A | 237 | 284 | 332 | 379 | 426 | 474 | 521 | 569 | 616 | 664 | N/A | N/A |
| <i>Replacement Upholstery Covers</i> | | | | | | | | | | | | | |

ARM CHAIR / URETHANE ARMS / ACCEPTS TABLE ON RIGHT

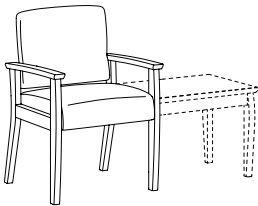

Overall: 23.5"w 24"d 34"h **Arm:** 25"h **COM:** 1.75 yds.
Seat: 20"w 19"d 18.5"h **Weight:** 45 lbs. **COL:** n/a

| COM | COL | 1 | 2 | 3 | 4 | 5 | 6 | 7 | 8 | 9 | 10 | L1 | L2 |
|---|-----|------|------|------|------|------|------|------|------|------|------|-----|-----|
| 1822-T | N/A | 1269 | 1301 | 1344 | 1387 | 1431 | 1474 | 1517 | 1561 | 1604 | 1647 | N/A | N/A |
| <i>Open Back / Tight Seat & Back / Removable Upholstery / 350 lb. Weight Capacity</i> | | | | | | | | | | | | | |
| 1820-R | N/A | 237 | 284 | 332 | 379 | 426 | 474 | 521 | 569 | 616 | 664 | N/A | N/A |
| <i>Replacement Upholstery Covers</i> | | | | | | | | | | | | | |

ARM CHAIR / URETHANE ARMS / ACCEPTS TABLE ON LEFT

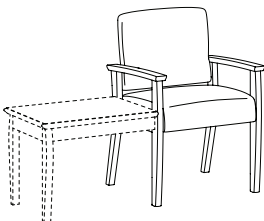

Overall: 23.5"w 24"d 34"h **Arm:** 25"h **COM:** 1.75 yds.
Seat: 20"w 19"d 18.5"h **Weight:** 45 lbs. **COL:** n/a

| COM | COL | 1 | 2 | 3 | 4 | 5 | 6 | 7 | 8 | 9 | 10 | L1 | L2 |
|---|-----|------|------|------|------|------|------|------|------|------|------|-----|-----|
| 1822-LT | N/A | 1269 | 1301 | 1344 | 1387 | 1431 | 1474 | 1517 | 1561 | 1604 | 1647 | N/A | N/A |
| <i>Open Back / Tight Seat & Back / Removable Upholstery / 350 lb. Weight Capacity</i> | | | | | | | | | | | | | |
| 1820-R | N/A | 237 | 284 | 332 | 379 | 426 | 474 | 521 | 569 | 616 | 664 | N/A | N/A |
| <i>Replacement Upholstery Covers</i> | | | | | | | | | | | | | |

DESCRIPTION:

- Upholstery Frames: Steel, Plywood & Hardwood
- Seat: High Density Polyurethane Foam Over Strap Webbing
- Back: High Density Polyurethane Foam Over Plywood
- Upholstered Covers: Attached w/ Velcro / Removable For Maintenance
- Exposed Wood Legs: Solid Hardwood / Removable For Maintenance / Wallsaver Legs
- Antimicrobial Moisture Barrier Fully Encapsulates All Foam Areas
- Leather Upholstery Not Available
- Adjustable Height Leveling Glides Standard
- Lifetime Warranty

OPTIONS:

- EPAC-1 Black Polyester Arm Caps (Set Of 2).....\$374
- Closed Arm Panels (See 1800-PL / 1800-PR Item #s)..... CALL FOR PRICING

Specify Exposed Wood Finish (See Page 6)

NOTE: All Seating Configurations Are Viewed From Left To Right Facing. Please Attach A Layout Showing Seating Configuration w/ Your Order. Assembled Units Must Be Shipped In Configurations Of 3 Or Less.

TANDEM

ITEM #:

SPECIFICATIONS | GRADES | LIST PRICES:

ARM CHAIR / URETHANE ARMS / ACCEPTS TABLE ON LEFT / SEAT ON RIGHT

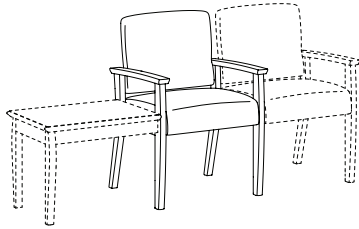

1822-TC

1820-R

| Overall: 23.5"w 24"d 34"h | | Arm: 25"h | | COM: 1.75 yds. | | | | | | | | | |
|---|-----|------------------------|------|-----------------------|------|------|------|------|------|------|------|-----|-----|
| Seat: 20"w 19"d 18.5"h | | Weight: 45 lbs. | | COL: n/a | | | | | | | | | |
| COM | COL | 1 | 2 | 3 | 4 | 5 | 6 | 7 | 8 | 9 | 10 | L1 | L2 |
| 1238 | N/A | 1269 | 1301 | 1344 | 1387 | 1431 | 1474 | 1517 | 1561 | 1604 | 1647 | N/A | N/A |
| <i>Open Back / Tight Seat & Back / Removable Upholstery / 350 lb. Weight Capacity</i> | | | | | | | | | | | | | |
| 150 | N/A | 237 | 284 | 332 | 379 | 426 | 474 | 521 | 569 | 616 | 664 | N/A | N/A |
| <i>Replacement Upholstery Covers</i> | | | | | | | | | | | | | |

ARM CHAIR / URETHANE ARMS / ACCEPTS TABLE ON LEFT / RIGHT

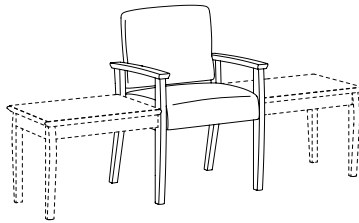

1822-TT

1820-R

| Overall: 23.5"w 24"d 34"h | | Arm: 25"h | | COM: 1.75 yds. | | | | | | | | | |
|---|-----|------------------------|------|-----------------------|------|------|------|------|------|------|------|-----|-----|
| Seat: 20"w 19"d 18.5"h | | Weight: 45 lbs. | | COL: n/a | | | | | | | | | |
| COM | COL | 1 | 2 | 3 | 4 | 5 | 6 | 7 | 8 | 9 | 10 | L1 | L2 |
| 1238 | N/A | 1269 | 1301 | 1344 | 1387 | 1431 | 1474 | 1517 | 1561 | 1604 | 1647 | N/A | N/A |
| <i>Open Back / Tight Seat & Back / Removable Upholstery / 350 lb. Weight Capacity</i> | | | | | | | | | | | | | |
| 150 | N/A | 237 | 284 | 332 | 379 | 426 | 474 | 521 | 569 | 616 | 664 | N/A | N/A |
| <i>Replacement Upholstery Covers</i> | | | | | | | | | | | | | |

DESCRIPTION:

- Upholstery Frames: Steel, Plywood & Hardwood
- Seat: High Density Polyurethane Foam Over Strap Webbing
- Back: High Density Polyurethane Foam Over Plywood
- Upholstered Covers: Attached w/ Velcro / Removable For Maintenance
- Exposed Wood Legs: Solid Hardwood / Removable For Maintenance / Wallsaver Legs
- Antimicrobial Moisture Barrier Fully Encapsulates All Foam Areas
- Leather Upholstery Not Available
- Adjustable Height Leveling Glides Standard
- Lifetime Warranty

OPTIONS:

- EPAC-1 Black Polyester Arm Caps (Set Of 2).....\$374
- Closed Arm Panels (See 1800-PL / 1800-PR Item #s)..... CALL FOR PRICING

Specify Exposed Wood Finish (See Page 6)

NOTE: All Seating Configurations Are Viewed From Left To Right Facing. Please Attach A Layout Showing Seating Configuration w/ Your Order. Assembled Units Must Be Shipped In Configurations Of 3 Or Less.

TANDEM

ITEM #:

SPECIFICATIONS | GRADES | LIST PRICES:

ADD-A-SEAT / URETHANE ARMS

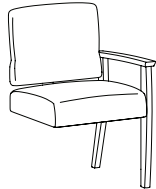

| | | | | | | | | | | | | | |
|---|------------|-----------------------------------|----------|------------------------|----------|-----------------------|----------|----------|----------|----------|-----------|-----------|-----------|
| | | Overall: 21.75"w 24"d 34"h | | Arm: 25"h | | COM: 1.75 yds. | | | | | | | |
| | | Seat: 20"w 19"d 18.5"h | | Weight: 40 lbs. | | COL: n/a | | | | | | | |
| COM | COL | 1 | 2 | 3 | 4 | 5 | 6 | 7 | 8 | 9 | 10 | L1 | L2 |
| 1823 | N/A | 1009 | 1053 | 1096 | 1139 | 1182 | 1226 | 1269 | 1312 | 1356 | 1399 | N/A | N/A |
| <i>Open Back / Tight Seat & Back / Removable Upholstery / 350 lb. Weight Capacity</i> | | | | | | | | | | | | | |
| 1820-R | N/A | 237 | 284 | 332 | 379 | 426 | 474 | 521 | 569 | 616 | 664 | N/A | N/A |
| <i>Replacement Upholstery Covers</i> | | | | | | | | | | | | | |

ADD-A-SEAT / URETHANE ARMS / ACCEPTS SEAT ON RIGHT

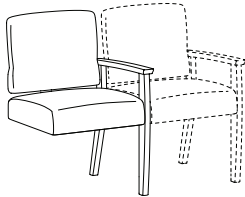

| | | | | | | | | | | | | | |
|---|------------|-----------------------------------|----------|------------------------|----------|-----------------------|----------|----------|----------|----------|-----------|-----------|-----------|
| | | Overall: 21.75"w 24"d 34"h | | Arm: 25"h | | COM: 1.75 yds. | | | | | | | |
| | | Seat: 20"w 19"d 18.5"h | | Weight: 40 lbs. | | COL: n/a | | | | | | | |
| COM | COL | 1 | 2 | 3 | 4 | 5 | 6 | 7 | 8 | 9 | 10 | L1 | L2 |
| 1823-C | N/A | 1009 | 1053 | 1096 | 1139 | 1182 | 1226 | 1269 | 1312 | 1356 | 1399 | N/A | N/A |
| <i>Open Back / Tight Seat & Back / Removable Upholstery / 350 lb. Weight Capacity</i> | | | | | | | | | | | | | |
| 1820-R | N/A | 237 | 284 | 332 | 379 | 426 | 474 | 521 | 569 | 616 | 664 | N/A | N/A |
| <i>Replacement Upholstery Covers</i> | | | | | | | | | | | | | |

ADD-A-SEAT / URETHANE ARMS / ACCEPTS TABLE ON RIGHT

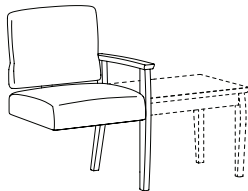

| | | | | | | | | | | | | | |
|---|------------|-----------------------------------|----------|------------------------|----------|-----------------------|----------|----------|----------|----------|-----------|-----------|-----------|
| | | Overall: 21.75"w 24"d 34"h | | Arm: 25"h | | COM: 1.75 yds. | | | | | | | |
| | | Seat: 20"w 19"d 18.5"h | | Weight: 40 lbs. | | COL: n/a | | | | | | | |
| COM | COL | 1 | 2 | 3 | 4 | 5 | 6 | 7 | 8 | 9 | 10 | L1 | L2 |
| 1823-T | N/A | 1009 | 1053 | 1096 | 1139 | 1182 | 1226 | 1269 | 1312 | 1356 | 1399 | N/A | N/A |
| <i>Open Back / Tight Seat & Back / Removable Upholstery / 350 lb. Weight Capacity</i> | | | | | | | | | | | | | |
| 1820-R | N/A | 237 | 284 | 332 | 379 | 426 | 474 | 521 | 569 | 616 | 664 | N/A | N/A |
| <i>Replacement Upholstery Covers</i> | | | | | | | | | | | | | |

DESCRIPTION:

- Upholstery Frames: Steel, Plywood & Hardwood
- Seat: High Density Polyurethane Foam Over Strap Webbing
- Back: High Density Polyurethane Foam Over Plywood
- Upholstered Covers: Attached w/ Velcro / Removable For Maintenance
- Exposed Wood Legs: Solid Hardwood / Removable For Maintenance / Wallsaver Legs
- Antimicrobial Moisture Barrier Fully Encapsulates All Foam Areas
- Leather Upholstery Not Available
- Adjustable Height Leveling Glides Standard
- Lifetime Warranty

OPTIONS:

Closed Arm Panels (See 1800-PL / 1800-PR Item #'s)..... CALL FOR PRICING
Specify Exposed Wood Finish (See Page 6)

NOTE: All Seating Configurations Are Viewed From Left To Right Facing. Please Attach A Layout Showing Seating Configuration w/ Your Order. Assembled Units Must Be Shipped In Configurations Of 3 Or Less.

BARIATRIC / TANDEM

ITEM #:

SPECIFICATIONS | GRADES | LIST PRICES:

BARIATRIC CHAIR / WOOD ARMS

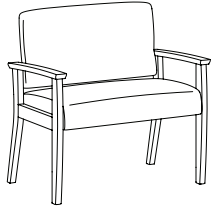

Overall: 33.5"w 24"d 34"h **Arm:** 25"h **COM:** 2.25 yds.
Seat: 30"w 19"d 18.5"h **Weight:** 55 lbs. **COL:** n/a

| COM | COL | 1 | 2 | 3 | 4 | 5 | 6 | 7 | 8 | 9 | 10 | L1 | L2 |
|---|-----|------|------|------|------|------|------|------|------|------|------|-----|-----|
| 1830 | N/A | 1614 | 1671 | 1729 | 1787 | 1845 | 1902 | 1960 | 2018 | 2076 | 2133 | N/A | N/A |
| <i>Open Back / Tight Seat & Back / Removable Upholstery / 500 lb. Weight Capacity</i> | | | | | | | | | | | | | |
| 1830-R | N/A | 279 | 342 | 405 | 468 | 531 | 595 | 658 | 721 | 784 | 848 | N/A | N/A |
| <i>Replacement Upholstery Covers</i> | | | | | | | | | | | | | |

BARIATRIC CHAIR / WOOD ARMS / ACCEPTS SEAT ON RIGHT

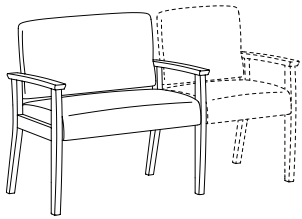

Overall: 33.5"w 24"d 34"h **Arm:** 25"h **COM:** 2.25 yds.
Seat: 30"w 19"d 18.5"h **Weight:** 55 lbs. **COL:** n/a

| COM | COL | 1 | 2 | 3 | 4 | 5 | 6 | 7 | 8 | 9 | 10 | L1 | L2 |
|---|-----|------|------|------|------|------|------|------|------|------|------|-----|-----|
| 1830-C | N/A | 1614 | 1671 | 1729 | 1787 | 1845 | 1902 | 1960 | 2018 | 2076 | 2133 | N/A | N/A |
| <i>Open Back / Tight Seat & Back / Removable Upholstery / 500 lb. Weight Capacity</i> | | | | | | | | | | | | | |
| 1830-R | N/A | 279 | 342 | 405 | 468 | 531 | 595 | 658 | 721 | 784 | 848 | N/A | N/A |
| <i>Replacement Upholstery Covers</i> | | | | | | | | | | | | | |

BARIATRIC CHAIR / WOOD ARMS / ACCEPTS TABLE ON RIGHT

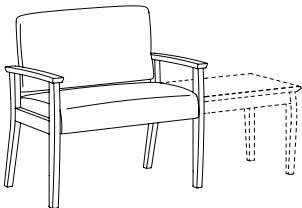

Overall: 33.5"w 24"d 34"h **Arm:** 25"h **COM:** 2.25 yds.
Seat: 30"w 19"d 18.5"h **Weight:** 55 lbs. **COL:** n/a

| COM | COL | 1 | 2 | 3 | 4 | 5 | 6 | 7 | 8 | 9 | 10 | L1 | L2 |
|---|-----|------|------|------|------|------|------|------|------|------|------|-----|-----|
| 1830-T | N/A | 1614 | 1671 | 1729 | 1787 | 1845 | 1902 | 1960 | 2018 | 2076 | 2133 | N/A | N/A |
| <i>Open Back / Tight Seat & Back / Removable Upholstery / 500 lb. Weight Capacity</i> | | | | | | | | | | | | | |
| 1830-R | N/A | 279 | 342 | 405 | 468 | 531 | 595 | 658 | 721 | 784 | 848 | N/A | N/A |
| <i>Replacement Upholstery Covers</i> | | | | | | | | | | | | | |

BARIATRIC CHAIR / WOOD ARMS / ACCEPTS TABLE ON LEFT

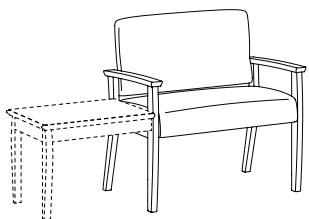

Overall: 33.5"w 24"d 34"h **Arm:** 25"h **COM:** 2.25 yds.
Seat: 30"w 19"d 18.5"h **Weight:** 55 lbs. **COL:** n/a

| COM | COL | 1 | 2 | 3 | 4 | 5 | 6 | 7 | 8 | 9 | 10 | L1 | L2 |
|---|-----|------|------|------|------|------|------|------|------|------|------|-----|-----|
| 1830-LT | N/A | 1614 | 1671 | 1729 | 1787 | 1845 | 1902 | 1960 | 2018 | 2076 | 2133 | N/A | N/A |
| <i>Open Back / Tight Seat & Back / Removable Upholstery / 500 lb. Weight Capacity</i> | | | | | | | | | | | | | |
| 1830-R | N/A | 279 | 342 | 405 | 468 | 531 | 595 | 658 | 721 | 784 | 848 | N/A | N/A |
| <i>Replacement Upholstery Covers</i> | | | | | | | | | | | | | |

DESCRIPTION:

- Upholstery Frames: Steel, Plywood & Hardwood
- Seat: High Density Polyurethane Foam Over Strap Webbing
- Back: High Density Polyurethane Foam Over Plywood
- Upholstered Covers: Attached w/ Velcro / Removable For Maintenance
- Exposed Wood Legs: Solid Hardwood / Removable For Maintenance / Wallsaver Legs
- Antimicrobial Moisture Barrier Fully Encapsulates All Foam Areas
- Leather Upholstery Not Available
- Adjustable Height Leveling Glides Standard
- Lifetime Warranty

OPTIONS:

Closed Arm Panels (See 1800-PL / 1800-PR Item #'s)..... CALL FOR PRICING
Specify Exposed Wood Finish (See Page 6)

NOTE: All Seating Configurations Are Viewed From Left To Right Facing. Please Attach A Layout Showing Seating Configuration w/ Your Order. Assembled Units Must Be Shipped In Configurations Of 3 Or Less.

BARIATRIC / TANDEM

ITEM #:

SPECIFICATIONS | GRADES | LIST PRICES:

**BARIATRIC CHAIR / WOOD ARMS /
ACCEPTS TABLE ON LEFT / SEAT ON RIGHT**

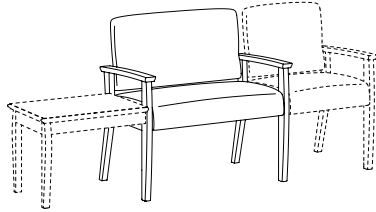

1830-TC

1830-R

| Overall: 33.5"w 24"d 34"h | | Arm: 25"h | | COM: 2.25 yds. | | | | | | | | | |
|---|-----|------------------------|------|-----------------------|------|------|------|------|------|------|------|-----|-----|
| Seat: 30"w 19"d 18.5"h | | Weight: 55 lbs. | | COL: n/a | | | | | | | | | |
| COM | COL | 1 | 2 | 3 | 4 | 5 | 6 | 7 | 8 | 9 | 10 | L1 | L2 |
| 1585 | N/A | 1614 | 1671 | 1729 | 1787 | 1845 | 1902 | 1960 | 2018 | 2076 | 2133 | N/A | N/A |
| <i>Open Back / Tight Seat & Back / Removable Upholstery / 500 lb. Weight Capacity</i> | | | | | | | | | | | | | |
| 161 | N/A | 279 | 342 | 405 | 468 | 531 | 595 | 658 | 721 | 784 | 848 | N/A | N/A |
| <i>Replacement Upholstery Covers</i> | | | | | | | | | | | | | |

**BARIATRIC CHAIR / WOOD ARMS /
ACCEPTS TABLE ON LEFT / RIGHT**

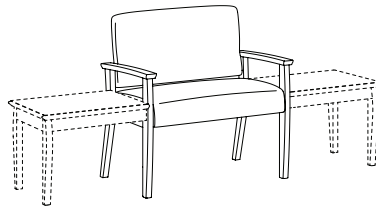

1830-TT

1830-R

| Overall: 33.5"w 24"d 34"h | | Arm: 25"h | | COM: 2.25 yds. | | | | | | | | | |
|---|-----|------------------------|------|-----------------------|------|------|------|------|------|------|------|-----|-----|
| Seat: 30"w 19"d 18.5"h | | Weight: 55 lbs. | | COL: n/a | | | | | | | | | |
| COM | COL | 1 | 2 | 3 | 4 | 5 | 6 | 7 | 8 | 9 | 10 | L1 | L2 |
| 1585 | N/A | 1614 | 1671 | 1729 | 1787 | 1845 | 1902 | 1960 | 2018 | 2076 | 2133 | N/A | N/A |
| <i>Open Back / Tight Seat & Back / Removable Upholstery / 500 lb. Weight Capacity</i> | | | | | | | | | | | | | |
| 161 | N/A | 279 | 342 | 405 | 468 | 531 | 595 | 658 | 721 | 784 | 848 | N/A | N/A |
| <i>Replacement Upholstery Covers</i> | | | | | | | | | | | | | |

DESCRIPTION:

- Upholstery Frames: Steel, Plywood & Hardwood
- Seat: High Density Polyurethane Foam Over Strap Webbing
- Back: High Density Polyurethane Foam Over Plywood
- Upholstered Covers: Attached w/ Velcro / Removable For Maintenance
- Exposed Wood Legs: Solid Hardwood / Removable For Maintenance / Wallsaver Legs
- Antimicrobial Moisture Barrier Fully Encapsulates All Foam Areas
- Leather Upholstery Not Available
- Adjustable Height Leveling Glides Standard
- Lifetime Warranty

OPTIONS:

Closed Arm Panels (See 1800-PL / 1800-PR Item #'s)..... CALL FOR PRICING
Specify Exposed Wood Finish (See Page 6)

NOTE: All Seating Configurations Are Viewed From Left To Right Facing. Please Attach A Layout Showing Seating Configuration w/ Your Order. Assembled Units Must Be Shipped In Configurations Of 3 Or Less.

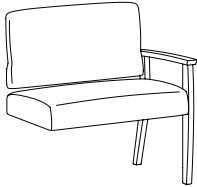
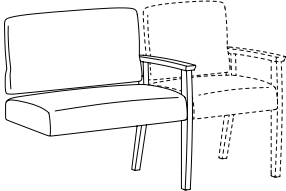
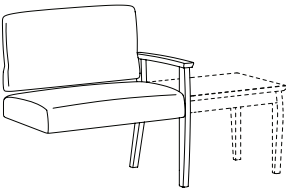
| BARIATRIC / TANDEM | | ITEM #: | SPECIFICATIONS GRADES LIST PRICES: | | | | | | | | | | | | | |
|---|--------|---------|--|-----|------|------------------------|------|------|-----------------------|------|------|------|------|------|-----|-----|
| BARIATRIC ADD-A-SEAT / WOOD ARMS | | | <i>Overall: 31.75"w 24"d 34"h</i> | | | <i>Arm: 25"h</i> | | | <i>COM: 2.25 yds.</i> | | | | | | | |
| | | | <i>Seat: 30"w 19"d 18.5"h</i> | | | <i>Weight: 52 lbs.</i> | | | <i>COL: n/a</i> | | | | | | | |
|  | | | COM | COL | 1 | 2 | 3 | 4 | 5 | 6 | 7 | 8 | 9 | 10 | L1 | L2 |
| | 1831 | | 1322 | N/A | 1365 | 1423 | 1481 | 1538 | 1596 | 1654 | 1712 | 1769 | 1827 | 1885 | N/A | N/A |
| <i>Open Back / Tight Seat & Back / Removable Upholstery / 500 lb. Weight Capacity</i> | | | | | | | | | | | | | | | | |
| | 1830-R | | 161 | N/A | 279 | 342 | 405 | 468 | 531 | 595 | 658 | 721 | 784 | 848 | N/A | N/A |
| <i>Replacement Upholstery Covers</i> | | | | | | | | | | | | | | | | |
| BARIATRIC ADD-A-SEAT / WOOD ARMS / ACCEPTS SEAT ON RIGHT | | | <i>Overall: 31.75"w 24"d 34"h</i> | | | <i>Arm: 25"h</i> | | | <i>COM: 2.25 yds.</i> | | | | | | | |
| | | | <i>Seat: 30"w 19"d 18.5"h</i> | | | <i>Weight: 52 lbs.</i> | | | <i>COL: n/a</i> | | | | | | | |
|  | | | COM | COL | 1 | 2 | 3 | 4 | 5 | 6 | 7 | 8 | 9 | 10 | L1 | L2 |
| | 1831-C | | 1322 | N/A | 1365 | 1423 | 1481 | 1538 | 1596 | 1654 | 1712 | 1769 | 1827 | 1885 | N/A | N/A |
| <i>Open Back / Tight Seat & Back / Removable Upholstery / 500 lb. Weight Capacity</i> | | | | | | | | | | | | | | | | |
| | 1830-R | | 161 | N/A | 279 | 342 | 405 | 468 | 531 | 595 | 658 | 721 | 784 | 848 | N/A | N/A |
| <i>Replacement Upholstery Covers</i> | | | | | | | | | | | | | | | | |
| BARIATRIC ADD-A-SEAT / WOOD ARMS / ACCEPTS TABLE ON RIGHT | | | <i>Overall: 31.75"w 24"d 34"h</i> | | | <i>Arm: 25"h</i> | | | <i>COM: 2.25 yds.</i> | | | | | | | |
| | | | <i>Seat: 30"w 19"d 18.5"h</i> | | | <i>Weight: 52 lbs.</i> | | | <i>COL: n/a</i> | | | | | | | |
|  | | | COM | COL | 1 | 2 | 3 | 4 | 5 | 6 | 7 | 8 | 9 | 10 | L1 | L2 |
| | 1831-T | | 1322 | N/A | 1365 | 1423 | 1481 | 1538 | 1596 | 1654 | 1712 | 1769 | 1827 | 1885 | N/A | N/A |
| <i>Open Back / Tight Seat & Back / Removable Upholstery / 500 lb. Weight Capacity</i> | | | | | | | | | | | | | | | | |
| | 1830-R | | 161 | N/A | 279 | 342 | 405 | 468 | 531 | 595 | 658 | 721 | 784 | 848 | N/A | N/A |
| <i>Replacement Upholstery Covers</i> | | | | | | | | | | | | | | | | |

DESCRIPTION:

- Upholstery Frames: Steel, Plywood & Hardwood
- Seat: High Density Polyurethane Foam Over Strap Webbing
- Back: High Density Polyurethane Foam Over Plywood
- Upholstered Covers: Attached w/ Velcro / Removable For Maintenance
- Exposed Wood Legs: Solid Hardwood / Removable For Maintenance / Wallsaver Legs
- Antimicrobial Moisture Barrier Fully Encapsulates All Foam Areas
- Leather Upholstery Not Available
- Adjustable Height Leveling Glides Standard
- Lifetime Warranty

OPTIONS:

- EPAC-1 Black Polyester Arm Caps (Set Of 2).....\$374
- Closed Arm Panels (See 1800-PL / 1800-PR Item #s)..... CALL FOR PRICING

Specify Exposed Wood Finish (See Page 6)

NOTE: All Seating Configurations Are Viewed From Left To Right Facing. Please Attach A Layout Showing Seating Configuration w/ Your Order. Assembled Units Must Be Shipped In Configurations Of 3 Or Less.

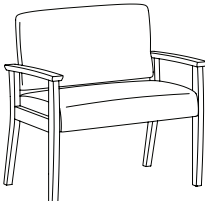
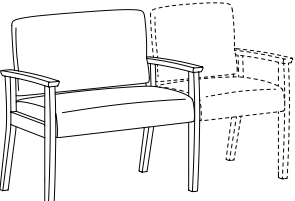
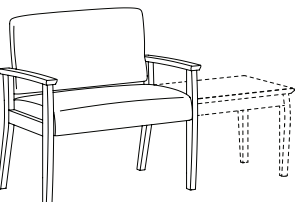
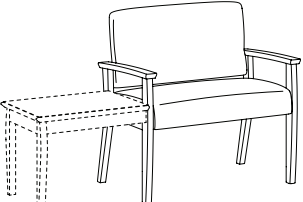
| BARIATRIC / TANDEM | | ITEM #: | SPECIFICATIONS GRADES LIST PRICES: | | | | | | | | | | | | | |
|---|--|---------|---|------------|------------------------|----------|-----------------------|----------|----------|----------|----------|----------|----------|-----------|-----------|-----------|
|  | | 1832 | Overall: 33.5"w 24"d 34"h | | Arm: 25"h | | COM: 2.25 yds. | | | | | | | | | |
| | | | Seat: 30"w 19"d 18.5"h | | Weight: 55 lbs. | | COL: n/a | | | | | | | | | |
| | | | COM | COL | 1 | 2 | 3 | 4 | 5 | 6 | 7 | 8 | 9 | 10 | L1 | L2 |
| | | | 1597 | N/A | 1625 | 1683 | 1741 | 1798 | 1856 | 1914 | 1972 | 2029 | 2087 | 2145 | N/A | N/A |
| | | | <i>Open Back / Tight Seat & Back / Removable Upholstery / 500 lb. Weight Capacity</i> | | | | | | | | | | | | | |
| | | 1830-R | 161 | N/A | 279 | 342 | 405 | 468 | 531 | 595 | 658 | 721 | 784 | 848 | N/A | N/A |
| | | | <i>Replacement Upholstery Covers</i> | | | | | | | | | | | | | |
|  | | 1832-C | Overall: 33.5"w 24"d 34"h | | Arm: 25"h | | COM: 2.25 yds. | | | | | | | | | |
| | | | Seat: 30"w 19"d 18.5"h | | Weight: 55 lbs. | | COL: n/a | | | | | | | | | |
| | | | COM | COL | 1 | 2 | 3 | 4 | 5 | 6 | 7 | 8 | 9 | 10 | L1 | L2 |
| | | | 1597 | N/A | 1625 | 1683 | 1741 | 1798 | 1856 | 1914 | 1972 | 2029 | 2087 | 2145 | N/A | N/A |
| | | | <i>Open Back / Tight Seat & Back / Removable Upholstery / 500 lb. Weight Capacity</i> | | | | | | | | | | | | | |
| | | 1830-R | 161 | N/A | 279 | 342 | 405 | 468 | 531 | 595 | 658 | 721 | 784 | 848 | N/A | N/A |
| | | | <i>Replacement Upholstery Covers</i> | | | | | | | | | | | | | |
|  | | 1832-T | Overall: 33.5"w 24"d 34"h | | Arm: 25"h | | COM: 2.25 yds. | | | | | | | | | |
| | | | Seat: 30"w 19"d 18.5"h | | Weight: 55 lbs. | | COL: n/a | | | | | | | | | |
| | | | COM | COL | 1 | 2 | 3 | 4 | 5 | 6 | 7 | 8 | 9 | 10 | L1 | L2 |
| | | | 1597 | N/A | 1625 | 1683 | 1741 | 1798 | 1856 | 1914 | 1972 | 2029 | 2087 | 2145 | N/A | N/A |
| | | | <i>Open Back / Tight Seat & Back / Removable Upholstery / 500 lb. Weight Capacity</i> | | | | | | | | | | | | | |
| | | 1830-R | 161 | N/A | 279 | 342 | 405 | 468 | 531 | 595 | 658 | 721 | 784 | 848 | N/A | N/A |
| | | | <i>Replacement Upholstery Covers</i> | | | | | | | | | | | | | |
|  | | 1832-LT | Overall: 33.5"w 24"d 34"h | | Arm: 25"h | | COM: 2.25 yds. | | | | | | | | | |
| | | | Seat: 30"w 19"d 18.5"h | | Weight: 55 lbs. | | COL: n/a | | | | | | | | | |
| | | | COM | COL | 1 | 2 | 3 | 4 | 5 | 6 | 7 | 8 | 9 | 10 | L1 | L2 |
| | | | 1597 | N/A | 1625 | 1683 | 1741 | 1798 | 1856 | 1914 | 1972 | 2029 | 2087 | 2145 | N/A | N/A |
| | | | <i>Open Back / Tight Seat & Back / Removable Upholstery / 500 lb. Weight Capacity</i> | | | | | | | | | | | | | |
| | | 1830-R | 161 | N/A | 279 | 342 | 405 | 468 | 531 | 595 | 658 | 721 | 784 | 848 | N/A | N/A |
| | | | <i>Replacement Upholstery Covers</i> | | | | | | | | | | | | | |

DESCRIPTION:

- Upholstery Frames: Steel, Plywood & Hardwood
- Seat: High Density Polyurethane Foam Over Strap Webbing
- Back: High Density Polyurethane Foam Over Plywood
- Upholstered Covers: Attached w/ Velcro / Removable For Maintenance
- Exposed Wood Legs: Solid Hardwood / Removable For Maintenance / Wallsaver Legs
- Antimicrobial Moisture Barrier Fully Encapsulates All Foam Areas
- Leather Upholstery Not Available
- Adjustable Height Leveling Glides Standard
- Lifetime Warranty

OPTIONS:

- EPAC-1 Black Polyester Arm Caps (Set Of 2).....\$374
- Closed Arm Panels (See 1800-PL / 1800-PR Item #s)..... CALL FOR PRICING

Specify Exposed Wood Finish (See Page 6)

NOTE: All Seating Configurations Are Viewed From Left To Right Facing. Please Attach A Layout Showing Seating Configuration w/ Your Order. Assembled Units Must Be Shipped In Configurations Of 3 Or Less.

BARIATRIC / TANDEM

ITEM #:

SPECIFICATIONS | GRADES | LIST PRICES:

BARIATRIC CHAIR / URETHANE ARMS / ACCEPTS TABLE ON LEFT / SEAT ON RIGHT

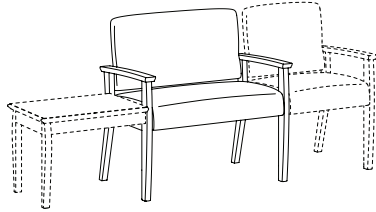

1832-TC

1830-R

| | | | <i>Overall: 33.5"w 24"d 34"h</i> | | <i>Arm: 25"h</i> | | <i>COM: 2.25 yds.</i> | | | | | | | |
|---|-----|--|----------------------------------|------|------------------------|------|-----------------------|------|------|------|------|------|-----|-----|
| | | | <i>Seat: 30"w 19"d 18.5"h</i> | | <i>Weight: 55 lbs.</i> | | <i>COL: n/a</i> | | | | | | | |
| COM | COL | | 1 | 2 | 3 | 4 | 5 | 6 | 7 | 8 | 9 | 10 | L1 | L2 |
| 1597 | N/A | | 1625 | 1683 | 1741 | 1798 | 1856 | 1914 | 1972 | 2029 | 2087 | 2145 | N/A | N/A |
| <i>Open Back / Tight Seat & Back / Removable Upholstery / 500 lb. Weight Capacity</i> | | | | | | | | | | | | | | |
| 161 | N/A | | 279 | 342 | 405 | 468 | 531 | 595 | 658 | 721 | 784 | 848 | N/A | N/A |
| <i>Replacement Upholstery Covers</i> | | | | | | | | | | | | | | |

BARIATRIC CHAIR / URETHANE ARMS / ACCEPTS TABLE ON LEFT / RIGHT

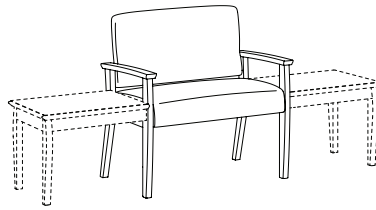

1832-TT

1830-R

| | | | <i>Overall: 33.5"w 24"d 34"h</i> | | <i>Arm: 25"h</i> | | <i>COM: 2.25 yds.</i> | | | | | | | |
|---|-----|--|----------------------------------|------|------------------------|------|-----------------------|------|------|------|------|------|-----|-----|
| | | | <i>Seat: 30"w 19"d 18.5"h</i> | | <i>Weight: 55 lbs.</i> | | <i>COL: n/a</i> | | | | | | | |
| COM | COL | | 1 | 2 | 3 | 4 | 5 | 6 | 7 | 8 | 9 | 10 | L1 | L2 |
| 1597 | N/A | | 1625 | 1683 | 1741 | 1798 | 1856 | 1914 | 1972 | 2029 | 2087 | 2145 | N/A | N/A |
| <i>Open Back / Tight Seat & Back / Removable Upholstery / 500 lb. Weight Capacity</i> | | | | | | | | | | | | | | |
| 161 | N/A | | 279 | 342 | 405 | 468 | 531 | 595 | 658 | 721 | 784 | 848 | N/A | N/A |
| <i>Replacement Upholstery Covers</i> | | | | | | | | | | | | | | |

DESCRIPTION:

- Upholstery Frames: Steel, Plywood & Hardwood
- Seat: High Density Polyurethane Foam Over Strap Webbing
- Back: High Density Polyurethane Foam Over Plywood
- Upholstered Covers: Attached w/ Velcro / Removable For Maintenance
- Exposed Wood Legs: Solid Hardwood / Removable For Maintenance / Wallsaver Legs
- Antimicrobial Moisture Barrier Fully Encapsulates All Foam Areas
- Leather Upholstery Not Available
- Adjustable Height Leveling Glides Standard
- Lifetime Warranty

OPTIONS:

- EPAC-1 Black Polyester Arm Caps (Set Of 2).....\$374
- Closed Arm Panels (See 1800-PL / 1800-PR Item #s)..... CALL FOR PRICING

Specify Exposed Wood Finish (See Page 6)

NOTE: All Seating Configurations Are Viewed From Left To Right Facing. Please Attach A Layout Showing Seating Configuration w/ Your Order. Assembled Units Must Be Shipped In Configurations Of 3 Or Less.

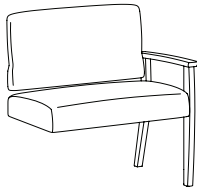
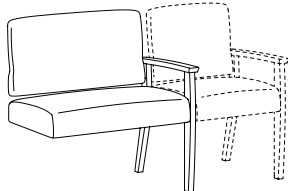
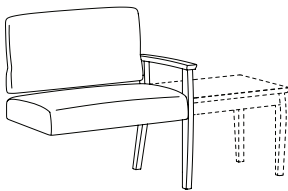
| BARIATRIC / TANDEM | | ITEM #: | SPECIFICATIONS GRADES LIST PRICES: | | | | | | | | | | | | |
|---|--|---|--|------------|----------|------------------------|----------|----------|-----------------------|----------|----------|----------|----------|-----------|-----------|
|  | | BARIATRIC ADD-A-SEAT / URETHANE ARMS | Overall: 31.75"w 24"d 34"h | | | Arm: 25"h | | | COM: 2.25 yds. | | | | | | |
| | | | Seat: 30"w 19"d 18.5"h | | | Weight: 52 lbs. | | | COL: n/a | | | | | | |
| | | | COM | COL | 1 | 2 | 3 | 4 | 5 | 6 | 7 | 8 | 9 | 10 | L1 |
| 1833 | | 1328 | N/A | 1371 | 1429 | 1486 | 1544 | 1602 | 1660 | 1717 | 1775 | 1833 | 1890 | N/A | N/A |
| <i>Open Back / Tight Seat & Back / Removable Upholstery / 500 lb. Weight Capacity</i> | | | | | | | | | | | | | | | |
| 1830-R | | 161 | N/A | 279 | 342 | 405 | 468 | 531 | 595 | 658 | 721 | 784 | 848 | N/A | N/A |
| <i>Replacement Upholstery Covers</i> | | | | | | | | | | | | | | | |
|  | | BARIATRIC ADD-A-SEAT / URETHANE ARMS / ACCEPTS SEAT ON RIGHT | Overall: 31.75"w 24"d 34"h | | | Arm: 25"h | | | COM: 2.25 yds. | | | | | | |
| | | | Seat: 30"w 19"d 18.5"h | | | Weight: 52 lbs. | | | COL: n/a | | | | | | |
| | | | COM | COL | 1 | 2 | 3 | 4 | 5 | 6 | 7 | 8 | 9 | 10 | L1 |
| 1833-C | | 1328 | N/A | 1371 | 1429 | 1486 | 1544 | 1602 | 1660 | 1717 | 1775 | 1833 | 1890 | N/A | N/A |
| <i>Open Back / Tight Seat & Back / Removable Upholstery / 500 lb. Weight Capacity</i> | | | | | | | | | | | | | | | |
| 1830-R | | 161 | N/A | 279 | 342 | 405 | 468 | 531 | 595 | 658 | 721 | 784 | 848 | N/A | N/A |
| <i>Replacement Upholstery Covers</i> | | | | | | | | | | | | | | | |
|  | | BARIATRIC ADD-A-SEAT / URETHANE ARMS / ACCEPTS TABLE ON RIGHT | Overall: 31.75"w 24"d 34"h | | | Arm: 25"h | | | COM: 2.25 yds. | | | | | | |
| | | | Seat: 30"w 19"d 18.5"h | | | Weight: 52 lbs. | | | COL: n/a | | | | | | |
| | | | COM | COL | 1 | 2 | 3 | 4 | 5 | 6 | 7 | 8 | 9 | 10 | L1 |
| 1833-T | | 1328 | N/A | 1371 | 1429 | 1486 | 1544 | 1602 | 1660 | 1717 | 1775 | 1833 | 1890 | N/A | N/A |
| <i>Open Back / Tight Seat & Back / Removable Upholstery / 500 lb. Weight Capacity</i> | | | | | | | | | | | | | | | |
| 1830-R | | 161 | N/A | 279 | 342 | 405 | 468 | 531 | 595 | 658 | 721 | 784 | 848 | N/A | N/A |
| <i>Replacement Upholstery Covers</i> | | | | | | | | | | | | | | | |

DESCRIPTION:

- Upholstery Frames: Steel, Plywood & Hardwood
- Seat: High Density Polyurethane Foam Over Strap Webbing
- Back: High Density Polyurethane Foam Over Plywood
- Upholstered Covers: Attached w/ Velcro / Removable For Maintenance
- Exposed Wood Legs: Solid Hardwood / Removable For Maintenance / Wallsaver Legs
- Antimicrobial Moisture Barrier Fully Encapsulates All Foam Areas
- Leather Upholstery Not Available
- Adjustable Height Leveling Glides Standard
- Lifetime Warranty

OPTIONS:

Closed Arm Panels (See 1800-PL / 1800-PR Item #'s)..... CALL FOR PRICING
Specify Exposed Wood Finish (See Page 6)

NOTE: All Seating Configurations Are Viewed From Left To Right Facing. Please Attach A Layout Showing Seating Configuration w/ Your Order. Assembled Units Must Be Shipped In Configurations Of 3 Or Less.

TANDEM

ITEM #:

SPECIFICATIONS | GRADES | LIST PRICES:

TWO PLACE SOFA / WOOD ARMS

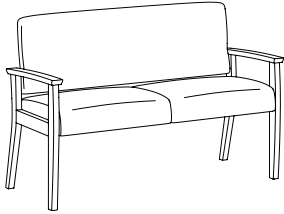

Overall: 51.5"w 24"d 34"h **Arm:** 25"h **COM:** 3.5 yds.
Seat: 48"w 19"d 18.5"h **Weight:** 65 lbs. **COL:** n/a

| COM | COL | 1 | 2 | 3 | 4 | 5 | 6 | 7 | 8 | 9 | 10 | L1 | L2 |
|---|-----|------|------|------|------|------|------|------|------|------|------|-----|-----|
| 1848 | N/A | 2110 | 2204 | 2297 | 2391 | 2485 | 2579 | 2673 | 2766 | 2860 | 2954 | N/A | N/A |
| <i>Open Back / Tight Seat & Back / Removable Upholstery / 750 lb. Weight Capacity</i> | | | | | | | | | | | | | |
| 1848-R | N/A | 416 | 519 | 621 | 724 | 827 | 930 | 1032 | 1135 | 1238 | 1341 | N/A | N/A |
| <i>Replacement Upholstery Covers</i> | | | | | | | | | | | | | |

TWO PLACE SOFA / WOOD ARMS / ACCEPTS SEAT ON RIGHT

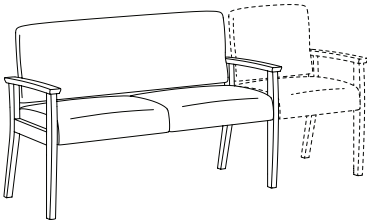

Overall: 51.5"w 24"d 34"h **Arm:** 25"h **COM:** 3.5 yds.
Seat: 48"w 19"d 18.5"h **Weight:** 65 lbs. **COL:** n/a

| COM | COL | 1 | 2 | 3 | 4 | 5 | 6 | 7 | 8 | 9 | 10 | L1 | L2 |
|---|-----|------|------|------|------|------|------|------|------|------|------|-----|-----|
| 1848-C | N/A | 2110 | 2204 | 2297 | 2391 | 2485 | 2579 | 2673 | 2766 | 2860 | 2954 | N/A | N/A |
| <i>Open Back / Tight Seat & Back / Removable Upholstery / 750 lb. Weight Capacity</i> | | | | | | | | | | | | | |
| 1848-R | N/A | 416 | 519 | 621 | 724 | 827 | 930 | 1032 | 1135 | 1238 | 1341 | N/A | N/A |
| <i>Replacement Upholstery Covers</i> | | | | | | | | | | | | | |

TWO PLACE SOFA / WOOD ARMS / ACCEPTS TABLE ON RIGHT

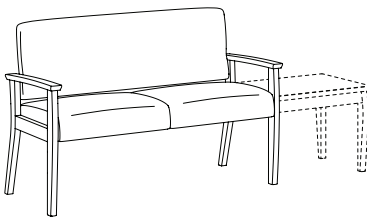

Overall: 51.5"w 24"d 34"h **Arm:** 25"h **COM:** 3.5 yds.
Seat: 48"w 19"d 18.5"h **Weight:** 65 lbs. **COL:** n/a

| COM | COL | 1 | 2 | 3 | 4 | 5 | 6 | 7 | 8 | 9 | 10 | L1 | L2 |
|---|-----|------|------|------|------|------|------|------|------|------|------|-----|-----|
| 1848-T | N/A | 2110 | 2204 | 2297 | 2391 | 2485 | 2579 | 2673 | 2766 | 2860 | 2954 | N/A | N/A |
| <i>Open Back / Tight Seat & Back / Removable Upholstery / 750 lb. Weight Capacity</i> | | | | | | | | | | | | | |
| 1848-R | N/A | 416 | 519 | 621 | 724 | 827 | 930 | 1032 | 1135 | 1238 | 1341 | N/A | N/A |
| <i>Replacement Upholstery Covers</i> | | | | | | | | | | | | | |

TWO PLACE SOFA / WOOD ARMS / ACCEPTS TABLE ON LEFT

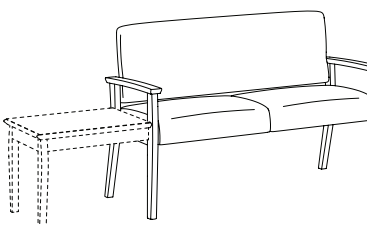

Overall: 51.5"w 24"d 34"h **Arm:** 25"h **COM:** 3.5 yds.
Seat: 48"w 19"d 18.5"h **Weight:** 65 lbs. **COL:** n/a

| COM | COL | 1 | 2 | 3 | 4 | 5 | 6 | 7 | 8 | 9 | 10 | L1 | L2 |
|---|-----|------|------|------|------|------|------|------|------|------|------|-----|-----|
| 1848-LT | N/A | 2110 | 2204 | 2297 | 2391 | 2485 | 2579 | 2673 | 2766 | 2860 | 2954 | N/A | N/A |
| <i>Open Back / Tight Seat & Back / Removable Upholstery / 750 lb. Weight Capacity</i> | | | | | | | | | | | | | |
| 1848-R | N/A | 416 | 519 | 621 | 724 | 827 | 930 | 1032 | 1135 | 1238 | 1341 | N/A | N/A |
| <i>Replacement Upholstery Covers</i> | | | | | | | | | | | | | |

DESCRIPTION:

- Upholstery Frames: Steel, Plywood & Hardwood
- Seat: High Density Polyurethane Foam Over Strap Webbing
- Back: High Density Polyurethane Foam Over Plywood
- Upholstered Covers: Attached w/ Velcro / Removable For Maintenance
- Exposed Wood Legs: Solid Hardwood / Removable For Maintenance / Wallsaver Legs
- Antimicrobial Moisture Barrier Fully Encapsulates All Foam Areas
- Leather Upholstery Not Available
- Adjustable Height Leveling Glides Standard
- Lifetime Warranty

OPTIONS:

Closed Arm Panels (See 1800-PL / 1800-PR Item #'s)..... CALL FOR PRICING
Specify Exposed Wood Finish (See Page 6)

NOTE: All Seating Configurations Are Viewed From Left To Right Facing. Please Attach A Layout Showing Seating Configuration w/ Your Order. Assembled Units Must Be Shipped In Configurations Of 3 Or Less.

TANDEM

ITEM #:

SPECIFICATIONS | GRADES | LIST PRICES:

**TWO PLACE SOFA / WOOD ARMS /
ACCEPTS TABLE ON LEFT / SEAT ON RIGHT**

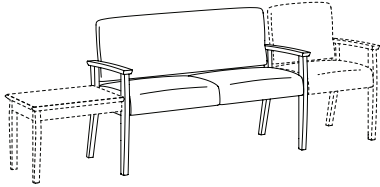

1848-TC

1848-R

| | | <i>Overall: 51.5"w 24"d 34"h</i> | | <i>Arm: 25"h</i> | | <i>COM: 3.5 yds.</i> | | | | | | | |
|---|-----|----------------------------------|------|------------------------|------|----------------------|------|------|------|------|------|-----|-----|
| | | <i>Seat: 48"w 19"d 18.5"h</i> | | <i>Weight: 65 lbs.</i> | | <i>COL: n/a</i> | | | | | | | |
| COM | COL | 1 | 2 | 3 | 4 | 5 | 6 | 7 | 8 | 9 | 10 | L1 | L2 |
| 2033 | N/A | 2110 | 2204 | 2297 | 2391 | 2485 | 2579 | 2673 | 2766 | 2860 | 2954 | N/A | N/A |
| <i>Open Back / Tight Seat & Back / Removable Upholstery / 750 lb. Weight Capacity</i> | | | | | | | | | | | | | |
| 223 | N/A | 416 | 519 | 621 | 724 | 827 | 930 | 1032 | 1135 | 1238 | 1341 | N/A | N/A |
| <i>Replacement Upholstery Covers</i> | | | | | | | | | | | | | |

**TWO PLACE SOFA / WOOD ARMS /
ACCEPTS TABLE ON LEFT / RIGHT**

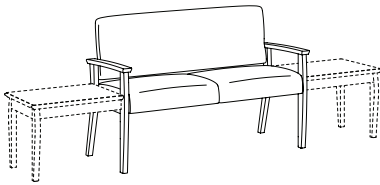

1848-TT

1848-R

| | | <i>Overall: 51.5"w 24"d 34"h</i> | | <i>Arm: 25"h</i> | | <i>COM: 3.5 yds.</i> | | | | | | | |
|---|-----|----------------------------------|------|------------------------|------|----------------------|------|------|------|------|------|-----|-----|
| | | <i>Seat: 48"w 19"d 18.5"h</i> | | <i>Weight: 65 lbs.</i> | | <i>COL: n/a</i> | | | | | | | |
| COM | COL | 1 | 2 | 3 | 4 | 5 | 6 | 7 | 8 | 9 | 10 | L1 | L2 |
| 2033 | N/A | 2110 | 2204 | 2297 | 2391 | 2485 | 2579 | 2673 | 2766 | 2860 | 2954 | N/A | N/A |
| <i>Open Back / Tight Seat & Back / Removable Upholstery / 750 lb. Weight Capacity</i> | | | | | | | | | | | | | |
| 223 | N/A | 416 | 519 | 621 | 724 | 827 | 930 | 1032 | 1135 | 1238 | 1341 | N/A | N/A |
| <i>Replacement Upholstery Covers</i> | | | | | | | | | | | | | |

DESCRIPTION:

- Upholstery Frames: Steel, Plywood & Hardwood
- Seat: High Density Polyurethane Foam Over Strap Webbing
- Back: High Density Polyurethane Foam Over Plywood
- Upholstered Covers: Attached w/ Velcro / Removable For Maintenance
- Exposed Wood Legs: Solid Hardwood / Removable For Maintenance / Wallsaver Legs
- Antimicrobial Moisture Barrier Fully Encapsulates All Foam Areas
- Leather Upholstery Not Available
- Adjustable Height Leveling Glides Standard
- Lifetime Warranty

OPTIONS:

Closed Arm Panels (See 1800-PL / 1800-PR Item #'s)..... CALL FOR PRICING
Specify Exposed Wood Finish (See Page 6)

NOTE: All Seating Configurations Are Viewed From Left To Right Facing. Please Attach A Layout Showing Seating Configuration w/ Your Order. Assembled Units Must Be Shipped In Configurations Of 3 Or Less.

TANDEM

ITEM #: SPECIFICATIONS | GRADES | LIST PRICES:

TWO PLACE ADD-A-SEAT / WOOD ARMS

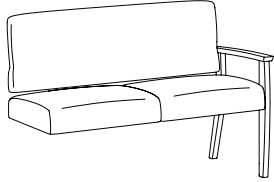

| | | | | | | | | | | | | | |
|---|------------|-----------------------------------|----------|------------------------|----------|----------------------|----------|----------|----------|----------|-----------|-----------|-----------|
| | | Overall: 49.75"w 24"d 34"h | | Arm: 25"h | | COM: 3.5 yds. | | | | | | | |
| | | Seat: 48"w 19"d 18.5"h | | Weight: 62 lbs. | | COL: n/a | | | | | | | |
| COM | COL | 1 | 2 | 3 | 4 | 5 | 6 | 7 | 8 | 9 | 10 | L1 | L2 |
| 1849 | N/A | 1860 | 1953 | 2047 | 2141 | 2235 | 2329 | 2422 | 2516 | 2610 | 2704 | N/A | N/A |
| <i>Open Back / Tight Seat & Back / Removable Upholstery / 750 lb. Weight Capacity</i> | | | | | | | | | | | | | |
| 1848-R | N/A | 416 | 519 | 621 | 724 | 827 | 930 | 1032 | 1135 | 1238 | 1341 | N/A | N/A |
| <i>Replacement Upholstery Covers</i> | | | | | | | | | | | | | |

TWO PLACE ADD-A-SEAT / WOOD ARMS / ACCEPTS SEAT ON RIGHT

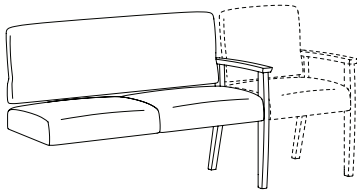

| | | | | | | | | | | | | | |
|---|------------|-----------------------------------|----------|------------------------|----------|----------------------|----------|----------|----------|----------|-----------|-----------|-----------|
| | | Overall: 49.75"w 24"d 34"h | | Arm: 25"h | | COM: 3.5 yds. | | | | | | | |
| | | Seat: 48"w 19"d 18.5"h | | Weight: 62 lbs. | | COL: n/a | | | | | | | |
| COM | COL | 1 | 2 | 3 | 4 | 5 | 6 | 7 | 8 | 9 | 10 | L1 | L2 |
| 1849-C | N/A | 1860 | 1953 | 2047 | 2141 | 2235 | 2329 | 2422 | 2516 | 2610 | 2704 | N/A | N/A |
| <i>Open Back / Tight Seat & Back / Removable Upholstery / 750 lb. Weight Capacity</i> | | | | | | | | | | | | | |
| 1848-R | N/A | 416 | 519 | 621 | 724 | 827 | 930 | 1032 | 1135 | 1238 | 1341 | N/A | N/A |
| <i>Replacement Upholstery Covers</i> | | | | | | | | | | | | | |

TWO PLACE ADD-A-SEAT / WOOD ARMS / ACCEPTS TABLE ON RIGHT

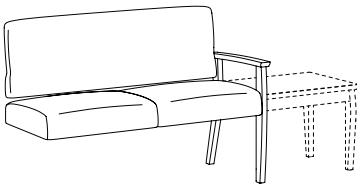

| | | | | | | | | | | | | | |
|---|------------|-----------------------------------|----------|------------------------|----------|----------------------|----------|----------|----------|----------|-----------|-----------|-----------|
| | | Overall: 49.75"w 24"d 34"h | | Arm: 25"h | | COM: 3.5 yds. | | | | | | | |
| | | Seat: 48"w 19"d 18.5"h | | Weight: 62 lbs. | | COL: n/a | | | | | | | |
| COM | COL | 1 | 2 | 3 | 4 | 5 | 6 | 7 | 8 | 9 | 10 | L1 | L2 |
| 1849-T | N/A | 1860 | 1953 | 2047 | 2141 | 2235 | 2329 | 2422 | 2516 | 2610 | 2704 | N/A | N/A |
| <i>Open Back / Tight Seat & Back / Removable Upholstery / 750 lb. Weight Capacity</i> | | | | | | | | | | | | | |
| 1848-R | N/A | 416 | 519 | 621 | 724 | 827 | 930 | 1032 | 1135 | 1238 | 1341 | N/A | N/A |
| <i>Replacement Upholstery Covers</i> | | | | | | | | | | | | | |

DESCRIPTION:

- Upholstery Frames: Steel, Plywood & Hardwood
- Seat: High Density Polyurethane Foam Over Strap Webbing
- Back: High Density Polyurethane Foam Over Plywood
- Upholstered Covers: Attached w/ Velcro / Removable For Maintenance
- Exposed Wood Legs: Solid Hardwood / Removable For Maintenance / Wallsaver Legs
- Antimicrobial Moisture Barrier Fully Encapsulates All Foam Areas
- Leather Upholstery Not Available
- Adjustable Height Leveling Glides Standard
- Lifetime Warranty

OPTIONS:

- EPAC-1 Black Polyester Arm Caps (Set Of 2).....\$374
- Closed Arm Panels (See 1800-PL / 1800-PR Item #s)..... CALL FOR PRICING

Specify Exposed Wood Finish (See Page 6)

NOTE: All Seating Configurations Are Viewed From Left To Right Facing. Please Attach A Layout Showing Seating Configuration w/ Your Order. Assembled Units Must Be Shipped In Configurations Of 3 Or Less.

TANDEM

ITEM #: SPECIFICATIONS | GRADES | LIST PRICES:

TWO PLACE SOFA / URETHANE ARMS

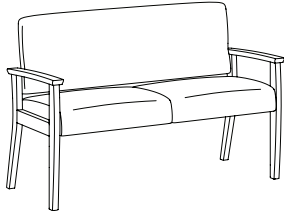

Overall: 51.5"w 24"d 34"h **Arm:** 25"h **COM:** 3.5 yds.
Seat: 48"w 19"d 18.5"h **Weight:** 65 lbs. **COL:** n/a

| COM | COL | 1 | 2 | 3 | 4 | 5 | 6 | 7 | 8 | 9 | 10 | L1 | L2 |
|---|-----|------|------|------|------|------|------|------|------|------|------|-----|-----|
| 1850 | N/A | 2133 | 2227 | 2321 | 2414 | 2508 | 2602 | 2696 | 2790 | 2884 | 2977 | N/A | N/A |
| <i>Open Back / Tight Seat & Back / Removable Upholstery / 750 lb. Weight Capacity</i> | | | | | | | | | | | | | |
| 1848-R | N/A | 416 | 519 | 621 | 724 | 827 | 930 | 1032 | 1135 | 1238 | 1341 | N/A | N/A |
| <i>Replacement Upholstery Covers</i> | | | | | | | | | | | | | |

TWO PLACE SOFA / URETHANE ARMS / ACCEPTS SEAT ON RIGHT

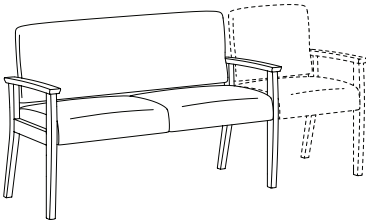

Overall: 51.5"w 24"d 34"h **Arm:** 25"h **COM:** 3.5 yds.
Seat: 48"w 19"d 18.5"h **Weight:** 65 lbs. **COL:** n/a

| COM | COL | 1 | 2 | 3 | 4 | 5 | 6 | 7 | 8 | 9 | 10 | L1 | L2 |
|---|-----|------|------|------|------|------|------|------|------|------|------|-----|-----|
| 1850-C | N/A | 2133 | 2227 | 2321 | 2414 | 2508 | 2602 | 2696 | 2790 | 2884 | 2977 | N/A | N/A |
| <i>Open Back / Tight Seat & Back / Removable Upholstery / 750 lb. Weight Capacity</i> | | | | | | | | | | | | | |
| 1848-R | N/A | 416 | 519 | 621 | 724 | 827 | 930 | 1032 | 1135 | 1238 | 1341 | N/A | N/A |
| <i>Replacement Upholstery Covers</i> | | | | | | | | | | | | | |

TWO PLACE SOFA / URETHANE ARMS / ACCEPTS TABLE ON RIGHT

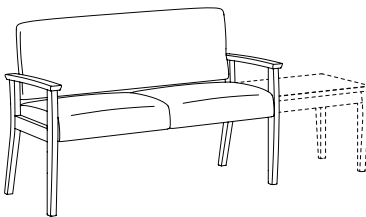

Overall: 51.5"w 24"d 34"h **Arm:** 25"h **COM:** 3.5 yds.
Seat: 48"w 19"d 18.5"h **Weight:** 65 lbs. **COL:** n/a

| COM | COL | 1 | 2 | 3 | 4 | 5 | 6 | 7 | 8 | 9 | 10 | L1 | L2 |
|---|-----|------|------|------|------|------|------|------|------|------|------|-----|-----|
| 1850-T | N/A | 2133 | 2227 | 2321 | 2414 | 2508 | 2602 | 2696 | 2790 | 2884 | 2977 | N/A | N/A |
| <i>Open Back / Tight Seat & Back / Removable Upholstery / 750 lb. Weight Capacity</i> | | | | | | | | | | | | | |
| 1848-R | N/A | 416 | 519 | 621 | 724 | 827 | 930 | 1032 | 1135 | 1238 | 1341 | N/A | N/A |
| <i>Replacement Upholstery Covers</i> | | | | | | | | | | | | | |

TWO PLACE SOFA / URETHANE ARMS / ACCEPTS TABLE ON LEFT

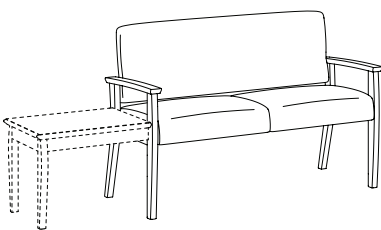

Overall: 51.5"w 24"d 34"h **Arm:** 25"h **COM:** 3.5 yds.
Seat: 48"w 19"d 18.5"h **Weight:** 65 lbs. **COL:** n/a

| COM | COL | 1 | 2 | 3 | 4 | 5 | 6 | 7 | 8 | 9 | 10 | L1 | L2 |
|---|-----|------|------|------|------|------|------|------|------|------|------|-----|-----|
| 1850-LT | N/A | 2133 | 2227 | 2321 | 2414 | 2508 | 2602 | 2696 | 2790 | 2884 | 2977 | N/A | N/A |
| <i>Open Back / Tight Seat & Back / Removable Upholstery / 750 lb. Weight Capacity</i> | | | | | | | | | | | | | |
| 1848-R | N/A | 416 | 519 | 621 | 724 | 827 | 930 | 1032 | 1135 | 1238 | 1341 | N/A | N/A |
| <i>Replacement Upholstery Covers</i> | | | | | | | | | | | | | |

DESCRIPTION:

- Upholstery Frames: Steel, Plywood & Hardwood
- Seat: High Density Polyurethane Foam Over Strap Webbing
- Back: High Density Polyurethane Foam Over Plywood
- Upholstered Covers: Attached w/ Velcro / Removable For Maintenance
- Exposed Wood Legs: Solid Hardwood / Removable For Maintenance / Wallsaver Legs
- Antimicrobial Moisture Barrier Fully Encapsulates All Foam Areas
- Leather Upholstery Not Available
- Adjustable Height Leveling Glides Standard
- Lifetime Warranty

OPTIONS:

- EPAC-1 Black Polyester Arm Caps (Set Of 2).....\$374
- Closed Arm Panels (See 1800-PL / 1800-PR Item #s)..... CALL FOR PRICING

Specify Exposed Wood Finish (See Page 6)

NOTE: All Seating Configurations Are Viewed From Left To Right Facing. Please Attach A Layout Showing Seating Configuration w/ Your Order. Assembled Units Must Be Shipped In Configurations Of 3 Or Less.

TANDEM

ITEM #:

SPECIFICATIONS | GRADES | LIST PRICES:

TWO PLACE SOFA / URETHANE ARMS / ACCEPTS TABLE ON LEFT / SEAT ON RIGHT

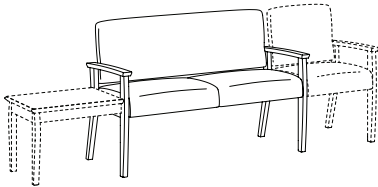

1850-TC

1848-R

Overall: 51.5"w 24"d 34"h **Arm:** 25"h **COM:** 3.5 yds.
Seat: 48"w 19"d 18.5"h **Weight:** 65 lbs. **COL:** n/a

| COM | COL | 1 | 2 | 3 | 4 | 5 | 6 | 7 | 8 | 9 | 10 | L1 | L2 |
|---|-----|------|------|------|------|------|------|------|------|------|------|-----|-----|
| 2058 | N/A | 2133 | 2227 | 2321 | 2414 | 2508 | 2602 | 2696 | 2790 | 2884 | 2977 | N/A | N/A |
| <i>Open Back / Tight Seat & Back / Removable Upholstery / 750 lb. Weight Capacity</i> | | | | | | | | | | | | | |
| 223 | N/A | 416 | 519 | 621 | 724 | 827 | 930 | 1032 | 1135 | 1238 | 1341 | N/A | N/A |
| <i>Replacement Upholstery Covers</i> | | | | | | | | | | | | | |

TWO PLACE SOFA / URETHANE ARMS / ACCEPTS TABLE ON LEFT / RIGHT

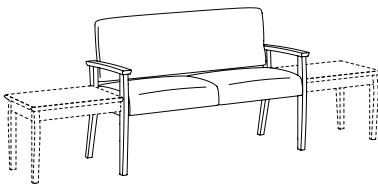

1850-TT

1848-R

Overall: 51.5"w 24"d 34"h **Arm:** 25"h **COM:** 3.5 yds.
Seat: 48"w 19"d 18.5"h **Weight:** 65 lbs. **COL:** n/a

| COM | COL | 1 | 2 | 3 | 4 | 5 | 6 | 7 | 8 | 9 | 10 | L1 | L2 |
|---|-----|------|------|------|------|------|------|------|------|------|------|-----|-----|
| 2058 | N/A | 2133 | 2227 | 2321 | 2414 | 2508 | 2602 | 2696 | 2790 | 2884 | 2977 | N/A | N/A |
| <i>Open Back / Tight Seat & Back / Removable Upholstery / 750 lb. Weight Capacity</i> | | | | | | | | | | | | | |
| 223 | N/A | 416 | 519 | 621 | 724 | 827 | 930 | 1032 | 1135 | 1238 | 1341 | N/A | N/A |
| <i>Replacement Upholstery Covers</i> | | | | | | | | | | | | | |

DESCRIPTION:

- Upholstery Frames: Steel, Plywood & Hardwood
- Seat: High Density Polyurethane Foam Over Strap Webbing
- Back: High Density Polyurethane Foam Over Plywood
- Upholstered Covers: Attached w/ Velcro / Removable For Maintenance
- Exposed Wood Legs: Solid Hardwood / Removable For Maintenance / Wallsaver Legs
- Antimicrobial Moisture Barrier Fully Encapsulates All Foam Areas
- Leather Upholstery Not Available
- Adjustable Height Leveling Glides Standard
- Lifetime Warranty

OPTIONS:

- EPAC-1 Black Polyester Arm Caps (Set Of 2).....\$374
- Closed Arm Panels (See 1800-PL / 1800-PR Item #s)..... CALL FOR PRICING

Specify Exposed Wood Finish (See Page 6)

NOTE: All Seating Configurations Are Viewed From Left To Right Facing. Please Attach A Layout Showing Seating Configuration w/ Your Order. Assembled Units Must Be Shipped In Configurations Of 3 Or Less.

TANDEM

ITEM #:

SPECIFICATIONS | GRADES | LIST PRICES:

TWO PLACE ADD-A-SEAT / URETHANE ARMS

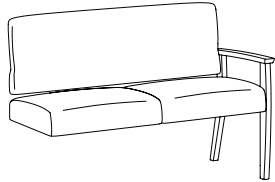

Overall: 49.75"w 24"d 34"h **Arm:** 25"h **COM:** 3.5 yds.
Seat: 48"w 19"d 18.5"h **Weight:** 62 lbs. **COL:** n/a

| COM | COL | 1 | 2 | 3 | 4 | 5 | 6 | 7 | 8 | 9 | 10 | L1 | L2 |
|---|-----|------|------|------|------|------|------|------|------|------|------|-----|-----|
| 1851 | N/A | 1906 | 2000 | 2093 | 2187 | 2281 | 2375 | 2469 | 2562 | 2656 | 2750 | N/A | N/A |
| <i>Open Back / Tight Seat & Back / Removable Upholstery / 750 lb. Weight Capacity</i> | | | | | | | | | | | | | |
| 1848-R | N/A | 416 | 519 | 621 | 724 | 827 | 930 | 1032 | 1135 | 1238 | 1341 | N/A | N/A |
| <i>Replacement Upholstery Covers</i> | | | | | | | | | | | | | |

TWO PLACE ADD-A-SEAT / URETHANE ARMS / ACCEPTS SEAT ON RIGHT

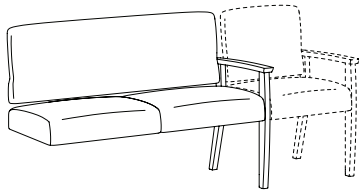

Overall: 49.75"w 24"d 34"h **Arm:** 25"h **COM:** 3.5 yds.
Seat: 48"w 19"d 18.5"h **Weight:** 62 lbs. **COL:** n/a

| COM | COL | 1 | 2 | 3 | 4 | 5 | 6 | 7 | 8 | 9 | 10 | L1 | L2 |
|---|-----|------|------|------|------|------|------|------|------|------|------|-----|-----|
| 1851-C | N/A | 1906 | 2000 | 2093 | 2187 | 2281 | 2375 | 2469 | 2562 | 2656 | 2750 | N/A | N/A |
| <i>Open Back / Tight Seat & Back / Removable Upholstery / 750 lb. Weight Capacity</i> | | | | | | | | | | | | | |
| 1848-R | N/A | 416 | 519 | 621 | 724 | 827 | 930 | 1032 | 1135 | 1238 | 1341 | N/A | N/A |
| <i>Replacement Upholstery Covers</i> | | | | | | | | | | | | | |

TWO PLACE ADD-A-SEAT / URETHANE ARMS / ACCEPTS TABLE ON RIGHT

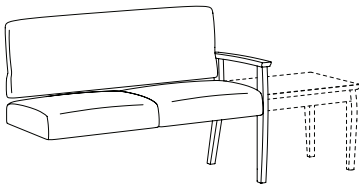

Overall: 49.75"w 24"d 34"h **Arm:** 25"h **COM:** 3.5 yds.
Seat: 48"w 19"d 18.5"h **Weight:** 62 lbs. **COL:** n/a

| COM | COL | 1 | 2 | 3 | 4 | 5 | 6 | 7 | 8 | 9 | 10 | L1 | L2 |
|---|-----|------|------|------|------|------|------|------|------|------|------|-----|-----|
| 1851-T | N/A | 1906 | 2000 | 2093 | 2187 | 2281 | 2375 | 2469 | 2562 | 2656 | 2750 | N/A | N/A |
| <i>Open Back / Tight Seat & Back / Removable Upholstery / 750 lb. Weight Capacity</i> | | | | | | | | | | | | | |
| 1848-R | N/A | 416 | 519 | 621 | 724 | 827 | 930 | 1032 | 1135 | 1238 | 1341 | N/A | N/A |
| <i>Replacement Upholstery Covers</i> | | | | | | | | | | | | | |

DESCRIPTION:

- Edge Banding / Legs: Solid Maple
- Wilsonart Plastic Laminates Standard. Alternate Selections May Be Specified From Most Major Laminate Manufacturers. (Contact Factory For Availability)
- Metal Support Leg 1" - 16 Gauge Steel Leg w/ Adjustable Glide (Attaches Via 4.5" Mounting Plate) (#18SC2626 Only)
- Lifetime Warranty

OPTIONS:

Specify Exposed Wood Finish / Laminate (See Page 6)

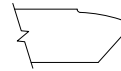

Evolve Edge Profile Standard

NOTE: All Seating Configurations Are Viewed From Left To Right Facing. Please Attach A Layout Showing Seating Configuration w/ Your Order. Assembled Units Must Be Shipped In Configurations Of 3 Or Less.

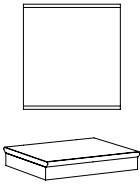
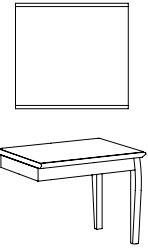
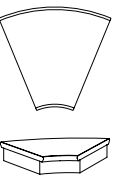
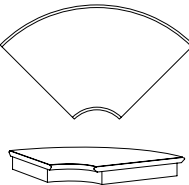
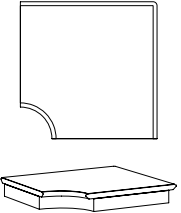
| CONNECTING TABLES | | ITEM #: | SPECIFICATIONS GRADES LIST PRICES: | | | | | | | | | | | | | | | | |
|--|-------------------|---------|---|------------|------------------------|----------|----------|----------|----------|----------|----------|----------|----------|-----------|-----------|-----------|--|--|--|
| STRAIGHT DIVIDER TABLE  | | | Overall: 20"w 20"d 18"h | | Weight: 45 lbs. | | | | | | | | | | | | | | |
| | | | COM | COL | 1 | 2 | 3 | 4 | 5 | 6 | 7 | 8 | 9 | 10 | L1 | L2 | | | |
| | 18C2020-L | 732 | High Pressure Laminate Face / Evolve Edge Profile Wood Band | | | | | | | | | | | | | | | | |
| | | | | | | | | | | | | | | | | | | | |
| | 18C2020-C | 779 | Solid Surface Top (Glacier White) / Evolve Edge Profile | | | | | | | | | | | | | | | | |
| 23" END TABLE  | | | Overall: 23"w 20"d 18"h | | Weight: 35 lbs. | | | | | | | | | | | | | | |
| | | | COM | COL | 1 | 2 | 3 | 4 | 5 | 6 | 7 | 8 | 9 | 10 | L1 | L2 | | | |
| | 18E2320-L | 875 | High Pressure Laminate Face / Evolve Edge Profile Wood Band | | | | | | | | | | | | | | | | |
| | 18E2320-C | 1363 | Solid Surface Face (Glacier White) / Evolve Edge Profile | | | | | | | | | | | | | | | | |
| 45° CORNER TABLE  | | | Overall: 21"w 20"d 18"h | | Weight: 30 lbs. | | | | | | | | | | | | | | |
| | | | COM | COL | 1 | 2 | 3 | 4 | 5 | 6 | 7 | 8 | 9 | 10 | L1 | L2 | | | |
| | 18RC45-L | 689 | High Pressure Laminate Face / Evolve Edge Profile Wood Band | | | | | | | | | | | | | | | | |
| | 18RC45-C | 994 | Solid Surface Face (Glacier White) / Evolve Edge Profile | | | | | | | | | | | | | | | | |
| 90° CORNER TABLE  | | | Overall: 26"w 26"d 18"h | | Weight: 45 lbs. | | | | | | | | | | | | | | |
| | | | COM | COL | 1 | 2 | 3 | 4 | 5 | 6 | 7 | 8 | 9 | 10 | L1 | L2 | | | |
| | 18RC90-L | 888 | High Pressure Laminate Face / Evolve Edge Profile Wood Band | | | | | | | | | | | | | | | | |
| | 18RC90-C | 1462 | Solid Surface Face (Glacier White) / Evolve Edge Profile | | | | | | | | | | | | | | | | |
| 90° CORNER TABLE / METAL SUPPORT LEG  | | | Overall: 26"w 26"d 18"h | | Weight: 48 lbs. | | | | | | | | | | | | | | |
| | | | COM | COL | 1 | 2 | 3 | 4 | 5 | 6 | 7 | 8 | 9 | 10 | L1 | L2 | | | |
| | 18SC2626-L | 895 | High Pressure Laminate Face / Evolve Edge Profile Wood Band | | | | | | | | | | | | | | | | |
| | 18SC2626-C | 1786 | Solid Surface Face (Glacier White) / Evolve Edge Profile | | | | | | | | | | | | | | | | |

DESCRIPTION:





- Edge Banding / Legs: Solid Maple
- Wilsonart Plastic Laminates Standard. Alternate Selections May Be Specified From Most Major Laminate Manufacturers. (Contact Factory For Availability)
- Lifetime Warranty

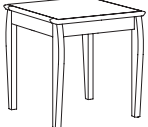
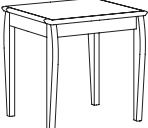

OPTIONS:

Specify Exposed Wood Finish / Laminate (See Page 6)



Evolve Edge Profile Standard

| TABLES | ITEM #: | SPECIFICATIONS GRADES LIST PRICES: | | | | | | | | | | | | | |
|--|------------------|--|------------|----------|----------|----------|------------------------|----------|----------|----------|----------|----------|-----------|-----------|-----------|
| 24" CORNER TABLE  | | Overall: 24"w 24"d 23"h | | | | | Weight: 35 lbs. | | | | | | | | |
| | | COM | COL | 1 | 2 | 3 | 4 | 5 | 6 | 7 | 8 | 9 | 10 | L1 | L2 |
| | 182424-L | 1000 <i>High Pressure Laminate Face / Evolve Edge Profile Wood Band</i> | | | | | | | | | | | | | |
| | 182424-C | 1381 <i>Solid Surface Face (Glacier White) / Evolve Edge Profile</i> | | | | | | | | | | | | | |
| 26" END TABLE  | | Overall: 22"w 26"d 23"h | | | | | Weight: 38 lbs. | | | | | | | | |
| | | COM | COL | 1 | 2 | 3 | 4 | 5 | 6 | 7 | 8 | 9 | 10 | L1 | L2 |
| | 182226-L | 1136 <i>High Pressure Laminate Face / Evolve Edge Profile Wood Band</i> | | | | | | | | | | | | | |
| | 182226-C | 1404 <i>Solid Surface Face (Glacier White) / Evolve Edge Profile</i> | | | | | | | | | | | | | |
| 42" RECTANGLE COFFEE TABLE  | | Overall: 42"w 20"d 16"h | | | | | Weight: 40 lbs. | | | | | | | | |
| | | COM | COL | 1 | 2 | 3 | 4 | 5 | 6 | 7 | 8 | 9 | 10 | L1 | L2 |
| | 184220-L | 1253 <i>High Pressure Laminate Face / Evolve Edge Profile Wood Band</i> | | | | | | | | | | | | | |
| | 184220-C | 1786 <i>Solid Surface Face (Glacier White) / Evolve Edge Profile</i> | | | | | | | | | | | | | |
| 26" ROUND END TABLE  | | Overall: 26" Diameter 23"h | | | | | Weight: 28 lbs. | | | | | | | | |
| | | COM | COL | 1 | 2 | 3 | 4 | 5 | 6 | 7 | 8 | 9 | 10 | L1 | L2 |
| | 1826D22-L | 1355 <i>High Pressure Laminate Face / Evolve Edge Profile Wood Band</i> | | | | | | | | | | | | | |
| | 1826D22-C | 1690 <i>Solid Surface Face (Glacier White) / Evolve Edge Profile</i> | | | | | | | | | | | | | |
| 34" ROUND COFFEE TABLE  | | Overall: 34" Diameter 16"h | | | | | Weight: 50 lbs. | | | | | | | | |
| | | COM | COL | 1 | 2 | 3 | 4 | 5 | 6 | 7 | 8 | 9 | 10 | L1 | L2 |
| | 1834D16-L | 1780 <i>High Pressure Laminate Face / Evolve Edge Profile Wood Band</i> | | | | | | | | | | | | | |
| | 1834D16-C | 2714 <i>Solid Surface Face (Glacier White) / Evolve Edge Profile</i> | | | | | | | | | | | | | |

| ARM CAPS / COVERS | OPTION #: | SPECIFICATIONS LIST PRICES AVAILABILITY: |
|--|---|--|
| <p>POLYESTER ARM CAPS</p>  | <p>EPAC-1</p> <p><i>Overall: 2.75"w 22.5"d 1.125"h</i></p> <hr/> <p>\$374 (Set Of 2) POLYESTER <i>Black Polyester Arm Cap (Additional Colors Available)</i></p> <p><i>Available: Facelift Evolve Guest / Tandem Collection (1822 / 1823 / 1832 / 1833 / 1850 / /1851)</i></p> | |
| <p>CONTRASTING COVERS</p>  | <p>CC</p> <p><i>Overall: N/A</i></p> <hr/> <p>\$129 <i>NOTE: If Two Or More Upholsteries Or Leathers Are Used On Any Piece Of Furniture, Then A Contrast Charge Will Apply Per Order. When Using Trinity Upholstery, The Higher Priced Upholstery Grade Will Be Used In Pricing, Unless It's Trinity Leather With Fabric Contrast Welt, Or COM With Trinity Contrast Welt, Then Contact Customer Service For Pricing.</i></p> <p><i>Available: Facelift Evolve Guest / Tandem Collection</i></p> | |

Facelift Evolve

HEALTHCARE MOTION

Effective: March 1, 2025

T R I N I T Y

Date:

Page:

Modification:

Description:

DESCRIPTION:

- Upholstery Frames: Steel, Plywood & Hardwood
- Seat: High Density Polyurethane Foam Over Strap Webbing
- Back: High Density Polyurethane Foam Over Sinuous Wire Springs
- Upholstered Covers: Attached w/ Velcro / Removable For Maintenance
- Exposed Wood Legs: Solid Hardwood / Removable For Maintenance
- Antimicrobial Moisture Barrier Fully Encapsulates All Foam Areas
- Leather Upholstery Not Available
- Lifetime Warranty

OPTIONS:

- Closed Arm Panels (See 1800-PL / 1800-PR Item #'s - Facelift Guest)
- Specify Exposed Wood Finish (See Page 6)

NOTE: All Seating Configurations Are Viewed From Left To Right Facing. Please Attach A Layout Showing Seating Configuration w/ Your Order. Assembled Units Must Be Shipped In Configurations Of 3 Or Less.

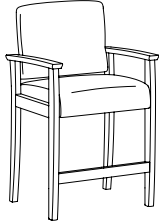
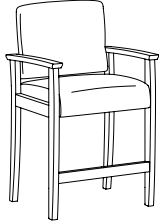
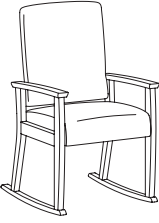
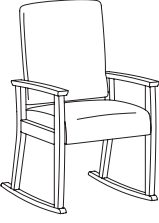
| PATIENT | ITEM #: | SPECIFICATIONS GRADES LIST PRICES: | | | | | | | | | | | | | |
|---|----------------|---|------------|------------------------|----------|----------|----------|----------|-----------------------|----------|----------|----------|-----------|-----------|-----------|
|  | | Overall: 23.75"w 24"d 38"h | | Arm: 29.5"h | | | | | COM: 1.75 yds. | | | | | | |
| | | Seat: 20.25"w 19"d 24"h | | Weight: 40 lbs. | | | | | COL: n/a | | | | | | |
| | | COM | COL | 1 | 2 | 3 | 4 | 5 | 6 | 7 | 8 | 9 | 10 | L1 | L2 |
| | 1820-H | 1299 | N/A | 1315 | 1358 | 1402 | 1445 | 1488 | 1532 | 1575 | 1618 | 1662 | 1705 | N/A | N/A |
| | | <i>Tight Seat & Back / Removable Upholstery / 350 lb. Weight Capacity</i> | | | | | | | | | | | | | |
| | 1820-R | 150 | N/A | 237 | 284 | 332 | 379 | 426 | 474 | 521 | 569 | 616 | 664 | N/A | N/A |
| | | <i>Replacement Upholstery Covers</i> | | | | | | | | | | | | | |
|  | | Overall: 23.75"w 24"d 38"h | | Arm: 29.5"h | | | | | COM: 1.75 yds. | | | | | | |
| | | Seat: 20.25"w 19"d 24"h | | Weight: 40 lbs. | | | | | COL: n/a | | | | | | |
| | | COM | COL | 1 | 2 | 3 | 4 | 5 | 6 | 7 | 8 | 9 | 10 | L1 | L2 |
| | 1822-H | 1336 | N/A | 1350 | 1393 | 1436 | 1480 | 1523 | 1566 | 1610 | 1653 | 1696 | 1739 | N/A | N/A |
| | | <i>Tight Seat & Back / Removable Upholstery / 350 lb. Weight Capacity</i> | | | | | | | | | | | | | |
| | 1820-R | 150 | N/A | 237 | 284 | 332 | 379 | 426 | 474 | 521 | 569 | 616 | 664 | N/A | N/A |
| | | <i>Replacement Upholstery Covers</i> | | | | | | | | | | | | | |
|  | | Overall: 23.5"w 28.75"d 45"h | | Arm: 25"h | | | | | COM: 2.25 yds. | | | | | | |
| | | Seat: 20"w 19"d 18.5"h | | Weight: 40 lbs. | | | | | COL: n/a | | | | | | |
| | | COM | COL | 1 | 2 | 3 | 4 | 5 | 6 | 7 | 8 | 9 | 10 | L1 | L2 |
| | 1824-RK | 1419 | N/A | 1457 | 1514 | 1572 | 1630 | 1688 | 1745 | 1803 | 1861 | 1919 | 1976 | N/A | N/A |
| | | <i>Tight Seat & Back / Removable Upholstery / 350 lb. Weight Capacity</i> | | | | | | | | | | | | | |
| | 1824-R | 155 | N/A | 273 | 336 | 400 | 463 | 526 | 589 | 652 | 716 | 779 | 842 | N/A | N/A |
| | | <i>Replacement Upholstery Covers</i> | | | | | | | | | | | | | |
| | | See Available Footstools Next Page | | | | | | | | | | | | | |
|  | | Overall: 23.5"w 28.75"d 45"h | | Arm: 25"h | | | | | COM: 2.25 yds. | | | | | | |
| | | Seat: 20"w 19"d 18.5"h | | Weight: 40 lbs. | | | | | COL: n/a | | | | | | |
| | | COM | COL | 1 | 2 | 3 | 4 | 5 | 6 | 7 | 8 | 9 | 10 | L1 | L2 |
| | 1825-RK | 1437 | N/A | 1474 | 1532 | 1590 | 1647 | 1705 | 1763 | 1820 | 1878 | 1936 | 1994 | N/A | N/A |
| | | <i>Tight Seat & Back / Removable Upholstery / 350 lb. Weight Capacity</i> | | | | | | | | | | | | | |
| | 1824-R | 155 | N/A | 273 | 336 | 400 | 463 | 526 | 589 | 652 | 716 | 779 | 842 | N/A | N/A |
| | | <i>Replacement Upholstery Covers</i> | | | | | | | | | | | | | |
| | | See Available Footstools Next Page | | | | | | | | | | | | | |



DESCRIPTION:

- Upholstery Frames: Steel, Plywood & Hardwood
- Seat: High Density Polyurethane Foam Over Strap Webbing
- Back: High Density Polyurethane Foam Over Sinuous Wire Springs
- Upholstered Covers: Attached w/ Velcro / Removable For Maintenance
- Exposed Wood Legs: Solid Hardwood / Removable For Maintenance
- Antimicrobial Moisture Barrier Fully Encapsulates All Foam Areas
- Leather Upholstery Not Available
- Lifetime Warranty

OPTIONS:

- Closed Arm Panels (See 1800-PL / 1800-PR Item #'s - Facelift Guest)
- Specify Exposed Wood Finish (See Page 6)

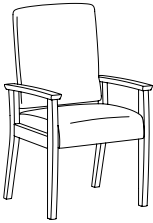
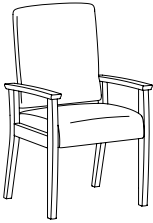
NOTE: All Seating Configurations Are Viewed From Left To Right Facing. Please Attach A Layout Showing Seating Configuration w/ Your Order. Assembled Units Must Be Shipped In Configurations Of 3 Or Less.

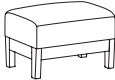
| PATIENT CHAIR / FOOTSTOOL | | ITEM #: | SPECIFICATIONS GRADES LIST PRICES: | | | | | | | | | | | | | |
|---|---|---------------|---|------------|----------|--|----------|----------|--|----------|----------|----------|----------|-----------|-----------|-----------|
|  | HIGH BACK PATIENT CHAIR / WOOD ARMS | | Overall: 23.5"w 26"d 45"h Seat: 20"w 19"d 18.5"h | | | Arm: 25"h Weight: 50 lbs. | | | COM: 2.25 yds. COL: n/a | | | | | | | |
| | | | COM | COL | 1 | 2 | 3 | 4 | 5 | 6 | 7 | 8 | 9 | 10 | L1 | L2 |
| | | 1824 | 1382 | N/A | 1408 | 1458 | 1509 | 1549 | 1610 | 1660 | 1711 | 1761 | 1812 | 1862 | N/A | N/A |
| | | 1824-R | 155 | N/A | 273 | 336 | 400 | 463 | 526 | 589 | 652 | 716 | 779 | 842 | N/A | N/A |
| | Headrest/Lumbar | 74 | N/A | 98 | 111 | 127 | 142 | 155 | 170 | 184 | 200 | 213 | 228 | N/A | N/A | |
| See Available Footstools Below | | | | | | | | | | | | | | | | |
|  | HIGH BACK PATIENT CHAIR / URETHANE ARMS | | Overall: 23.5"w 26"d 45"h Seat: 20"w 19"d 18.5"h | | | Arm: 25"h Weight: 50 lbs. | | | COM: 2.25 yds. COL: n/a | | | | | | | |
| | | | COM | COL | 1 | 2 | 3 | 4 | 5 | 6 | 7 | 8 | 9 | 10 | L1 | L2 |
| | | 1825 | 1388 | N/A | 1428 | 1486 | 1543 | 1601 | 1659 | 1717 | 1774 | 1832 | 1890 | 1947 | N/A | N/A |
| | | 1824-R | 155 | N/A | 273 | 336 | 400 | 463 | 526 | 589 | 652 | 716 | 779 | 842 | N/A | N/A |
| | Headrest/Lumbar | 74 | N/A | 98 | 111 | 127 | 142 | 155 | 170 | 184 | 200 | 213 | 228 | N/A | N/A | |
| See Available Footstools Below | | | | | | | | | | | | | | | | |
|  | OTTOMAN / FOOTSTOOL / SLOPED / STOWS UNDER ALL PATIENT & GLIDER CHAIRS | | Overall: 18"w 15"d 12"h Seat: n/a | | | Arm: n/a Weight: 27 lbs. | | | COM: 1.25 yds. COL: n/a | | | | | | | |
| | | | COM | COL | 1 | 2 | 3 | 4 | 5 | 6 | 7 | 8 | 9 | 10 | L1 | L2 |
| | | 1834 | 377 | N/A | 415 | 443 | 472 | 501 | 530 | 559 | 588 | 617 | 646 | 674 | N/A | N/A |
| | | 1834-R | 86 | N/A | 145 | 176 | 208 | 239 | 271 | 303 | 334 | 366 | 397 | 429 | N/A | N/A |
| | | | | | | | | | | | | | | | | |
|  | OTTOMAN / FOOTSTOOL / FLAT / STOWS UNDER ALL PATIENT & GLIDER CHAIRS | | Overall: 18"w 15"d 12"h Seat: n/a | | | Arm: n/a Weight: 27 lbs. | | | COM: 1.25 yds. COL: n/a | | | | | | | |
| | | | COM | COL | 1 | 2 | 3 | 4 | 5 | 6 | 7 | 8 | 9 | 10 | L1 | L2 |
| | | 1835 | 402 | N/A | 438 | 467 | 495 | 524 | 553 | 582 | 611 | 640 | 669 | 697 | N/A | N/A |
| | | 1835-R | 86 | N/A | 145 | 176 | 208 | 239 | 271 | 303 | 334 | 366 | 397 | 429 | N/A | N/A |

DESCRIPTION:

- Upholstery Frames: Steel, Plywood & Hardwood
- Seat: High Density Polyurethane Foam Over Sheet Webbing
- Back: High Density Polyurethane Foam Over Polypropylene Webbing
- Upholstered Covers: Attached w/ Velcro / Removable For Maintenance
- Removable Bolster Pillow For 1845 / 1846 (5" Diameter)
- Antimicrobial Moisture Barrier Fully Encapsulates All Foam Areas
- Double Needle Stitching Standard
- Metal To Metal Connections For All Hardware Assembly
- Leather Upholstery Not Available
- Lifetime Warranty

OPTIONS:

- EWAC-1 Solid Wood Arm Caps (Set Of 2)\$243
 - EUAC-1 Black Urethane Arm Caps (Set Of 2).....\$249
 - EPAC-2 Black Polyester Arm Caps (Set Of 2).....\$393
 - LC Locking Casters (Set Of 2).....\$44
 - NLC Non-Locking Casters (Set Of 2).....\$37
 - 3LC 3" Locking Casters - #1847 Model Only (Set Of 2).....\$218
 - PM1 Power/Data Module (1-Power / 1-USB 2 Port Simplex Charger)\$859
- (Additional Power/Data Modules Available - See Evolve Options)
 Feather Down & Polyester Pillows Available (See Page 5)
 Specify Exposed Wood Finish (See Page 6)
 Tablet Arm / Cup Holder Options (See Facelift Evolve Healthcare Options Pages)

SLEEPOVER UNITS

ITEM #: SPECIFICATIONS | GRADES | LIST PRICES:

LOUNGE CHAIR / FULLY UPHOLSTERED

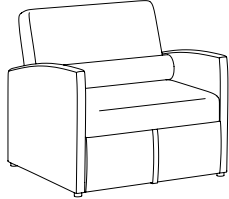

Healthcare Motion

| | | | | | | | | | | | | | |
|--|------------|---------------------------------------|----------|----------------------------------|----------|-------------------------|----------|----------------------|----------|----------|-----------|-----------|-----------|
| | | Overall: 33.5" w 34.5" d 33" h | | Overall Length: 84" d | | Arm: 24" h | | COM: 6.5 yds. | | | | | |
| | | Sleep Area: 28" w 80" d | | Seat: 28" w 23" d 17.5" h | | Weight: 175 lbs. | | COL: n/a | | | | | |
| COM | COL | 1 | 2 | 3 | 4 | 5 | 6 | 7 | 8 | 9 | 10 | L1 | L2 |
| 1845 | N/A | 4808 | 4989 | 5169 | 5349 | 5530 | 5710 | 5891 | 6071 | 6251 | 6432 | N/A | N/A |
| <i>Tight Seat & Back / Removable Upholstery / 500 lbs. Weight Capacity</i> | | | | | | | | | | | | | |
| 1845-R | N/A | 702 | 900 | 1097 | 1295 | 1493 | 1690 | 1888 | 2085 | 2283 | 2480 | N/A | N/A |
| <i>Replacement Upholstery Covers</i> | | | | | | | | | | | | | |

TWO PLACE SOFA / FULLY UPHOLSTERED

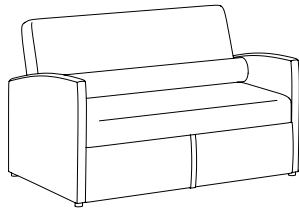

Healthcare Motion

| | | | | | | | | | | | | | |
|--|------------|-------------------------------------|----------|----------------------------------|----------|-------------------------|----------|--------------------|----------|----------|-----------|-----------|-----------|
| | | Overall: 53" w 34.5" d 33" h | | Overall Length: 84" d | | Arm: 24" h | | COM: 9 yds. | | | | | |
| | | Sleep Area: 48" w 80" d | | Seat: 48" w 23" d 17.5" h | | Weight: 220 lbs. | | COL: n/a | | | | | |
| COM | COL | 1 | 2 | 3 | 4 | 5 | 6 | 7 | 8 | 9 | 10 | L1 | L2 |
| 1846 | N/A | 6179 | 6431 | 6684 | 6937 | 7189 | 7442 | 7694 | 7947 | 8199 | 8452 | N/A | N/A |
| <i>Tight Seat & Back / Removable Upholstery / 750 lbs. Weight Capacity</i> | | | | | | | | | | | | | |
| 1846-R | N/A | 919 | 1195 | 1472 | 1749 | 2025 | 2302 | 2579 | 2855 | 3132 | 3408 | N/A | N/A |
| <i>Replacement Upholstery Covers</i> | | | | | | | | | | | | | |

FOUR POSITION ADJUSTMENT FOR 1845 / 1846

See [Replay Healthcare Motion And Revival Healthcare Motion \(Page 242\)](#) For Additional Sleepover Units.



1) Closed Position 2) Ottoman Position 3) Chaise Position 4) Full-Recline Position
 Overall Length - 84" d

BACK-FLIP SLEEPER SOFA

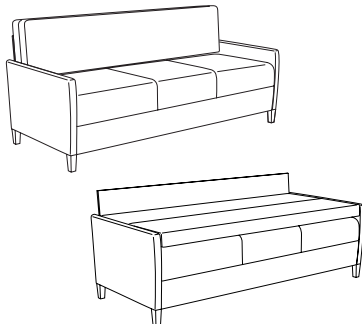

| | | | | | | | | | | | | | |
|---|------------|--------------------------------------|----------|-------------------------|----------|------------------------|----------|----------|----------|----------|-----------|-----------|-----------|
| | | Overall: 76" w 36" d 36" h | | Arm: 24.5" h | | COM: 12.25 yds. | | | | | | | |
| | | Sleep Area: 70" w 31" d 20" h | | Weight: 235 lbs. | | COL: n/a | | | | | | | |
| COM | COL | 1 | 2 | 3 | 4 | 5 | 6 | 7 | 8 | 9 | 10 | L1 | L2 |
| 1847 | N/A | 4766 | 5113 | 5459 | 5805 | 6152 | 6498 | 6844 | 7191 | 7537 | 7883 | N/A | N/A |
| <i>Tight Seat & Back / Removable Upholstery / 1000 lbs. Weight Capacity</i> | | | | | | | | | | | | | |
| 1847-R | N/A | 1945 | 2324 | 2703 | 3083 | 3462 | 3841 | 4221 | 4600 | 4979 | 5359 | N/A | N/A |
| <i>Replacement Upholstery Covers</i> | | | | | | | | | | | | | |

DESCRIPTION:

- Upholstery Frames: Steel, Plywood & Hardwood
- Seat: High Density Polyurethane Foam Over Sheet Webbing
- Back: High Density Polyurethane Foam Over Polypropylene Webbing
- Upholstered Covers: Attached w/ Velcro / Removable For Maintenance
- Antimicrobial Moisture Barrier Fully Encapsulates All Foam Areas
- Double Needle Stitching Standard
- Exposed Wood Legs: Solid Hardwood / Removable For Maintenance
- Leather Upholstery Not Available
- Lifetime Warranty

OPTIONS:

- EWAC-1 Solid Wood Arm Caps (Set Of 2)\$243
 - EUAC-1 Black Urethane Arm Caps (Set Of 2).....\$249
 - EPAC-2 Black Polyester Arm Caps (Set Of 2).....\$393
 - ARL Brushed Aluminum Round Legs (Set Of 4).....\$353
 - WR Wood Ring Base - Replaces Metal Base On 1854-G/1854-SG\$224
 - PM1 Power/Data Module (1-Power / 1-USB 2 Port Simplex Charger)\$859
- (Additional Power/Data Modules Available - See Evolve Options)
- Feather Down & Polyester Pillows Available (See Page 5)
- Specify Exposed Wood Finish (See Page 6)
- Tablet Arm / Cup Holder Options (See Facelift Evolve Healthcare Options Pages)

PATIENT CHAIR / GLIDER

ITEM #:

SPECIFICATIONS | GRADES | LIST PRICES:

ASYNCHRONOUS PATIENT CHAIR / FULLY UPHOLSTERED

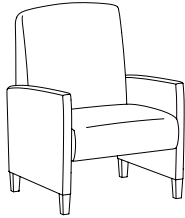

Healthcare Motion

Overall: 25"w 33.5"d 39.25"h **Arm:** 24.25"h **COM:** 4.25 yds.
Seat: 21"w 20"d 18.75"h **Weight:** 63 lbs. **COL:** n/a

| COM | COL | 1 | 2 | 3 | 4 | 5 | 6 | 7 | 8 | 9 | 10 | L1 | L2 |
|---|-----|------|------|------|------|------|------|------|------|------|------|-----|-----|
| 1852 | N/A | 1800 | 1934 | 2068 | 2201 | 2335 | 2469 | 2602 | 2736 | 2870 | 3003 | N/A | N/A |
| <i>Tight Seat & Back / Removable Upholstery / 500 lb. Weight Capacity</i> | | | | | | | | | | | | | |
| 1852-R | N/A | 482 | 609 | 735 | 862 | 988 | 1115 | 1241 | 1368 | 1494 | 1621 | N/A | N/A |
| <i>Replacement Upholstery Covers</i> | | | | | | | | | | | | | |

OTTOMAN ON CASTERS / STOWS UNDER ALL PATIENT CHAIRS

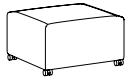

Healthcare Motion

Overall: 18"w 18"d 11"h **Arm:** n/a **COM:** 1 yd.
Seat: n/a **Weight:** 25 lbs. **COL:** n/a

| COM | COL | 1 | 2 | 3 | 4 | 5 | 6 | 7 | 8 | 9 | 10 | L1 | L2 |
|---|-----|-----|-----|-----|-----|-----|-----|-----|-----|-----|-----|-----|-----|
| 1809 | N/A | 409 | 430 | 452 | 474 | 495 | 517 | 539 | 560 | 582 | 603 | N/A | N/A |
| <i>Removable Upholstery / 350 lb. Weight Capacity</i> | | | | | | | | | | | | | |
| 1809-R | N/A | 136 | 160 | 183 | 207 | 231 | 254 | 278 | 302 | 326 | 349 | N/A | N/A |
| <i>Replacement Upholstery Covers</i> | | | | | | | | | | | | | |

LOUNGE GLIDER / FULLY UPHOLSTERED

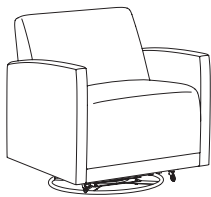

Healthcare Motion

Overall: 27"w 32"d 35"h **Arm:** 24"h **COM:** 4.5 yds.
Seat: 21"w 20"d 18"h **Weight:** 115 lbs. **COL:** n/a

| COM | COL | 1 | 2 | 3 | 4 | 5 | 6 | 7 | 8 | 9 | 10 | L1 | L2 |
|--|-----|------|------|------|------|------|------|------|------|------|------|-----|-----|
| 1854-G | N/A | 2053 | 2175 | 2298 | 2421 | 2543 | 2666 | 2789 | 2911 | 3034 | 3157 | N/A | N/A |
| <i>Circular Metal Base / Tight Seat & Back / Removable Upholstery / 500 lb. Weight Capacity</i> | | | | | | | | | | | | | |
| 1854-SG | N/A | 2174 | 2297 | 2419 | 2542 | 2665 | 2787 | 2910 | 3033 | 3155 | 3278 | N/A | N/A |
| <i>Swivel Glider w/ Circular Metal Base / Tight Seat & Back / Removable Upholstery / 500 lb. Weight Capacity</i> | | | | | | | | | | | | | |
| 1854-R | N/A | 506 | 641 | 775 | 909 | 1044 | 1178 | 1313 | 1447 | 1581 | 1716 | N/A | N/A |
| <i>Replacement Upholstery Covers</i> | | | | | | | | | | | | | |

See Replay Healthcare Motion And Revival Healthcare Motion For Additional Patient Chairs & Gliders.









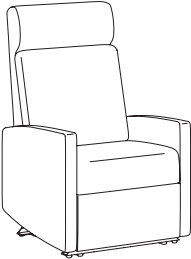

DESCRIPTION:

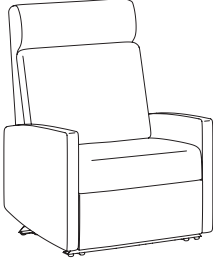
- Upholstery Frames: Steel, Plywood & Hardwood
- Seat: High Density Polyurethane Foam Over Sheet Webbing
- Back: High Density Polyurethane Foam Over Sinuous Wire Springs
- Upholstered Covers: Attached w/ Velcro / Removable For Maintenance
- Antimicrobial Moisture Barrier Fully Encapsulates All Foam Areas
- Double Needle Stitching Standard (Weltung Optional - No Charge)
- Dual-Wheel Casters: (2) Front Locking/Swivel & (2) Rear Non-Locking/Non-Swivel (1865)
- (2) Drop Down Side Trays Mounted To Black Metal Tubing (1865)
- Leather Upholstery Not Available
- Lifetime Warranty

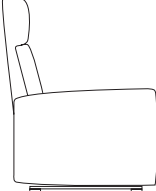
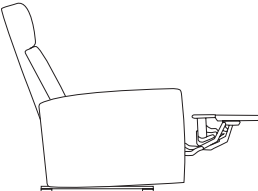
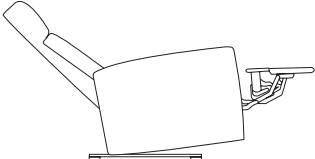
OPTIONS:

(See Facelift Evolve Healthcare Options Pages)

Feather Down & Polyester Pillows Available (See Page 5)







| WALLSAVER / INFUSION RECLINER | | ITEM #: | SPECIFICATIONS GRADES LIST PRICES: | | | | | | | | | | | | | | |
|---|----------------|---------|--|------------|----------|--|----------|----------|---|----------|----------|---|----------|-----------|-----------|-----------|--|
|  | | | Overall: 27"w 34"d 41.5"h | | | Arm: 23"h | | | COM: 4.75 yds. | | | | | | | | |
| | | | Seat: 21"w 21.5"d 18"h | | | Weight: 110 lbs. | | | COL: n/a | | | | | | | | |
| | | | COM | COL | 1 | 2 | 3 | 4 | 5 | 6 | 7 | 8 | 9 | 10 | L1 | L2 | |
| | 1855 | | N/A | 2257 | 2407 | 2558 | 2708 | 2858 | 3009 | 3159 | 3309 | 3460 | 3610 | N/A | N/A | | |
| | | | <i>Tight Seat & Back / Removable Upholstery / 6" Wall Proximity / 350 lb. Weight Capacity</i> | | | | | | | | | | | | | | |
| | 1855-R | | N/A | 559 | 702 | 844 | 986 | 1129 | 1271 | 1413 | 1555 | 1698 | 1840 | N/A | N/A | | |
| | | | <i>Replacement Upholstery Covers</i> | | | | | | | | | | | | | | |
| | | |  Healthcare Motion | | | | | | | | | | | | | | |
|  | | | Overall: 32"w 34"d 41.5"h | | | Arm: 23"h | | | COM: 5.25 yds. | | | | | | | | |
| | | | Seat: 26"w 21.5"d 18"h | | | Weight: 120 lbs. | | | COL: n/a | | | | | | | | |
| | | | COM | COL | 1 | 2 | 3 | 4 | 5 | 6 | 7 | 8 | 9 | 10 | L1 | L2 | |
| | 1855-X | | N/A | 2351 | 2518 | 2685 | 2852 | 3019 | 3186 | 3353 | 3520 | 3687 | 3854 | N/A | N/A | | |
| | | | <i>Tight Seat & Back / Removable Upholstery / 6" Wall Proximity / 500 lb. Weight Capacity</i> | | | | | | | | | | | | | | |
| | 1855-XR | | N/A | 597 | 755 | 914 | 1072 | 1230 | 1388 | 1546 | 1704 | 1862 | 2020 | N/A | N/A | | |
| | | | <i>Replacement Upholstery Covers</i> | | | | | | | | | | | | | | |
| | | |  Healthcare Motion | | | | | | | | | | | | | | |
| | | |  See <i>Replay Healthcare Motion And Revival Healthcare Motion For Additional Wallsaver Recliners.</i> | | | | | | | | | | | | | | |
| | | | | | |  Upright Position 34"D | | |  Extended Footrest Position 54.5"D | | |  Full Recline Position 65.5"D | | | | | |
|  | | | Overall: 26.25"w 34"d 46"h | | | Arm: 27"h | | | COM: 5 yds. | | | | | | | | |
| | | | Seat: 21"w 20.5"d 19"h | | | Weight: 130 lbs. | | | COL: n/a | | | | | | | | |
| | | | COM | COL | 1 | 2 | 3 | 4 | 5 | 6 | 7 | 8 | 9 | 10 | L1 | L2 | |
| | 1865 | | N/A | 3141 | 3293 | 3446 | 3599 | 3751 | 3904 | 4057 | 4210 | 4362 | 4515 | N/A | N/A | | |
| | | | <i>Tight Seat & Back / Removable Upholstery / 350 lb. Weight Capacity</i> | | | | | | | | | | | | | | |
| | 1865-R | | N/A | 653 | 827 | 1001 | 1175 | 1349 | 1523 | 1697 | 1870 | 2044 | 2218 | N/A | N/A | | |
| | | | <i>Replacement Upholstery Covers</i> | | | | | | | | | | | | | | |
| | | |  Healthcare Motion | | | | | | | | | | | | | | |
| | | |  See <i>Replay & Revival Healthcare Motion For Additional Infusion Wallsaver Recliners.</i> | | | | | | | | | | | | | | |
| | | | | | |  Upright Position 32"D | | |  Extended Footrest Position 52"D | | |  Full Recline Position 64.5"D | | | | | |
| | | | <div style="border: 1px solid black; padding: 2px; display: inline-block;">Optional Central Braking Available</div> | | | | | | | | | | | | | | |

DESCRIPTION:

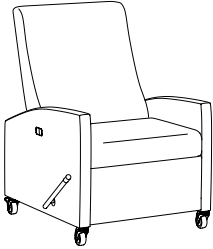
- Upholstery Frames: Steel, Plywood & Hardwood
- Seat: High Density Polyurethane Foam Over Sheet Webbing
- Back: High Density Polyurethane Foam Over Sinuous Wire Springs
- Upholstered Covers: Attached w/ Velcro / Removable For Maintenance
- Antimicrobial Moisture Barrier Fully Encapsulates All Foam Areas
- Double Needle Stitching Standard (Welting Optional - No Charge)
- Rotational & Directional Locking Casters (Rear)
- Leather Upholstery Not Available
- Lifetime Warranty

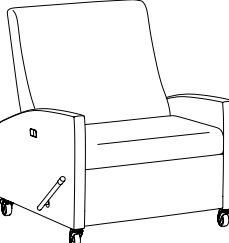
OPTIONS:

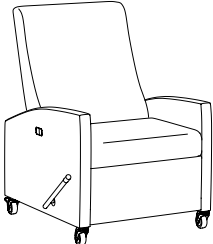
Layflat Medical Recliner Options (See Facelift Evolve Healthcare Options Pages)
 Feather Down & Polyester Pillows Available (See Page 5)

| LAYFLAT MEDICAL RECLINER | | SPECIFICATIONS GRADES LIST PRICES: | | | | | | | | | | | | | |
|---|-----------------|---|------------|----------|----------|-------------------------|----------|----------|----------|----------------------|----------|----------|-----------|-----------|-----------|
| LAYFLAT / TRENDELENBURG RECLINER | | Overall: 30"w 38.5"d 45"h | | | | Arm: 28"h | | | | COM: 5.5 yds. | | | | | |
| | | Seat: 24"w 20"d 20"h | | | | Weight: 175 lbs. | | | | COL: n/a | | | | | |
| | | COM | COL | 1 | 2 | 3 | 4 | 5 | 6 | 7 | 8 | 9 | 10 | L1 | L2 |
|  | 1857-L | 3656 | N/A | 3808 | 3983 | 4159 | 4334 | 4509 | 4685 | 4860 | 5036 | 5211 | 5386 | N/A | N/A |
| | | <i>Layflat / Tight Seat & Back / Removable Upholstery / 500 lb. Weight Capacity</i> | | | | | | | | | | | | | |
| | 1857-T | 3798 | N/A | 3941 | 4117 | 4292 | 4468 | 4643 | 4818 | 4994 | 5169 | 5345 | 5520 | N/A | N/A |
| | | <i>Trendelenburg / Tight Seat & Back / Removable Upholstery / 500 lb. Weight Capacity</i> | | | | | | | | | | | | | |
| | 1857-R | 328 | N/A | 642 | 808 | 974 | 1140 | 1306 | 1472 | 1638 | 1804 | 1970 | 2136 | N/A | N/A |
| | | <i>Replacement Upholstery Covers</i> | | | | | | | | | | | | | |
| | |  Healthcare Motion | | | | | | | | | | | | | |
| BARIATRIC LAYFLAT / TRENDELENBURG RECLINER | | Overall: 35"w 38.5"d 45"h | | | | Arm: 28"h | | | | COM: 6 yds. | | | | | |
| | | Seat: 29"w 20"d 20"h | | | | Weight: 200 lbs. | | | | COL: n/a | | | | | |
| | | COM | COL | 1 | 2 | 3 | 4 | 5 | 6 | 7 | 8 | 9 | 10 | L1 | L2 |
|  | 1857-XL | 3784 | N/A | 3961 | 4154 | 4346 | 4538 | 4730 | 4922 | 5114 | 5306 | 5498 | 5690 | N/A | N/A |
| | | <i>Bariatric Layflat / Tight Seat & Back / Removable Upholstery / 600 lb. Weight Capacity</i> | | | | | | | | | | | | | |
| | 1857-XT | 3939 | N/A | 4108 | 4301 | 4493 | 4685 | 4877 | 5069 | 5261 | 5453 | 5645 | 5837 | N/A | N/A |
| | | <i>Bariatric Trendelenburg / Tight Seat & Back / Removable Upholstery / 600 lb. Weight Capacity</i> | | | | | | | | | | | | | |
| | 1857-XR | 335 | N/A | 680 | 862 | 1044 | 1225 | 1407 | 1589 | 1771 | 1952 | 2134 | 2316 | N/A | N/A |
| | | <i>Replacement Upholstery Covers</i> | | | | | | | | | | | | | |
| | |  Healthcare Motion | | | | | | | | | | | | | |
| LAYFLAT GLIDER / RECLINER | | Overall: 28"w 38.5"d 45"h | | | | Arm: 27"h | | | | COM: 5.5 yds. | | | | | |
| | | Seat: 23"w 20"d 19"h | | | | Weight: 175 lbs. | | | | COL: n/a | | | | | |
| | | COM | COL | 1 | 2 | 3 | 4 | 5 | 6 | 7 | 8 | 9 | 10 | L1 | L2 |
|  | 1857-LG | 4208 | N/A | 4362 | 4554 | 4747 | 4939 | 5131 | 5323 | 5515 | 5707 | 5899 | 6091 | N/A | N/A |
| | | <i>Layflat Glider / Tight Seat & Back / Removable Upholstery / 500 lb. Weight Capacity</i> | | | | | | | | | | | | | |
| | 1857-LGR | 328 | N/A | 642 | 808 | 974 | 1140 | 1306 | 1472 | 1638 | 1804 | 1970 | 2136 | N/A | N/A |
| | | <i>Replacement Upholstery Covers</i> | | | | | | | | | | | | | |
| | |  Healthcare Motion | | | | | | | | | | | | | |

 See **Replay Healthcare Motion And Revival Healthcare Motion For Additional Layflat Medical Recliners.**

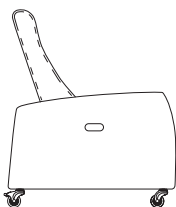

Upright Position
38.5"D

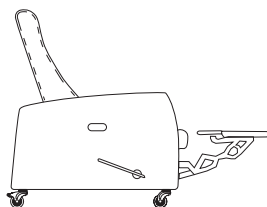

Extended Footrest Position
57.5"D

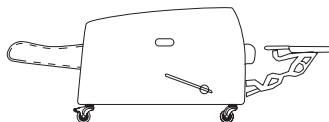



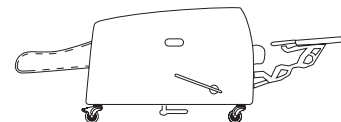





Layflat Position
73.75"D



Trendelenburg Position
74.75"D

| ARM CAPS / TABLET ARMS | OPTION #: | SPECIFICATIONS LIST PRICES AVAILABILITY: |
|--|--|--|
| <p>SOLID WOOD / URETHANE / POLYESTER ARM CAPS (Upholstered Arm Chairs)</p>    | <p>Overall: 2.75"w 29"d 1.125"h</p> <p>EWAC-1 \$243 (Set Of 2) WOOD (1845 / 1846 Sleepover Lounge) - Specify Finish (1852 Asynchronous Patient Chair) - Specify Finish (1854-G Lounge Glider / 1854-SG Lounge Swivel Glider) - Specify Finish (1855 Wallsaver Recliner / 1855-X Bariatric Wallsaver Recliner) - Specify Finish (1857-L & 1857-T Medical Recliners / 1857-XL & 1857-XT Bariatric Medical Recliners) - Specify Finish</p> <p>EUAC-1 \$249 (Set Of 2) URETHANE (1845 / 1846 Sleepover Lounge) (1852 Asynchronous Patient Chair) (1854-G Lounge Glider / 1854-SG Lounge Swivel Glider) (1855 Wallsaver Recliner / 1855-X Bariatric Wallsaver Recliner) (1857-L & 1857-T Medical Recliners / 1857-XL & 1857-XT Bariatric Medical Recliners)</p> <p>EPAC-2 \$393 (Set Of 2) POLYESTER (1845 / 1846 Sleepover Lounge) (1852 Asynchronous Patient Chair) (1854-G Lounge Glider / 1854-SG Lounge Swivel Glider) (1855 Wallsaver Recliner / 1855-X Bariatric Wallsaver Recliner) (1857-L & 1857-T Medical Recliners / 1857-XL & 1857-XT Bariatric Medical Recliners)</p> <p><i>Black Polyester Arm Cap (Additional Colors Available)</i></p> | |
| <p>TABLET ARMS / CUP HOLDER</p>  <p>Laminate Tablet Arm Shown w/ Cup Holder</p>  <p>Veneer Tablet Arm Shown w/ Cup Holder</p>  <p>Solid Surface Tablet Arm Shown w/ Cup Holder</p> | <p>Overall: 14" Diameter .75"h</p> <p>TA-L \$509 <i>Tablet Arm With 360° Rotation - High Pressure Laminate. (Specify Laminate / Specify Left Or Right Facing Arm Location)</i></p> <p>TA-V \$580 <i>Tablet Arm With 360° Rotation - Sunburst Cherry Veneer. (Specify Finish / Specify Left Or Right Facing Arm Location)</i></p> <p>TA-C \$698 <i>Tablet Arm With 360° Rotation - White Solid Surface. (Available In White Only / Specify Left Or Right Facing Arm Location)</i></p> <p>CH-1 \$129 <i>Black Plastic Cup Holder (Only Available If Used With Tablet Arm)</i></p> <p>CH-2 \$186 <i>Spun Aluminum Cup Holder (Only Available If Used With Tablet Arm)</i></p> <p>Available: <i>Facelift Evolve Healthcare Collection</i></p> | |
| <p>FOLD DOWN TABLET ARM</p>   | <p>Overall: 14" Diameter .75"h</p> <p>FDTA-L \$1065 <i>Tablet Arm With 360° Rotation - High Pressure Laminate. (Specify Laminate / Specify Left Or Right Facing Arm Location)</i></p> <p>FDTA-V \$1136 <i>Tablet Arm With 360° Rotation - Sunburst Cherry Veneer. (Specify Finish / Specify Left Or Right Facing Arm Location)</i></p> <p>FDTA-C \$1278 <i>Tablet Arm With 360° Rotation - White Solid Surface. (Available In White Only / Specify Left Or Right Facing Arm Location)</i></p> <p>Available: <i>Facelift Evolve Healthcare Collection</i></p> | |

| TABLET ARMS / POWER / CASTERS | OPTION #: | SPECIFICATIONS LIST PRICES AVAILABILITY: |
|---|--|--|
| <p>DOUBLE ARTICULATING / SWIVEL TABLET ARM</p>  <p>ATA-L Double Articulating / Swivel Tablet Arm</p>  <p>ATA-L w/ CH-1 Black Plastic Cup Holder</p> | <p>Overall: 14" Diameter .75"h</p> <hr/> <p>ATA-L \$983 Tablet Arm With 360° Rotation - High Pressure Laminate. (Specify Laminate / Specify Left Or Right Facing Arm Location)</p> <p>ATA-V \$1055 Tablet Arm With 360° Rotation - Sunburst Cherry Veneer. (Specify Finish / Specify Left Or Right Facing Arm Location)</p> <p>ATA-C \$1173 Tablet Arm With 360° Rotation - White Solid Surface. (Available In White Only / Specify Left Or Right Facing Arm Location)</p> <p>CH-1 \$129 Black Plastic Cup Holder (Only Available If Used With Tablet Arm)</p> <p>CH-2 \$186 Spun Aluminum Cup Holder (Only Available If Used With Tablet Arm)</p> <p>Available: Facelift Evolve Healthcare Collection</p> | |
| <p>SIDE MOUNT / FOLD DOWN TABLET W/ LOCK & SWIVEL</p> | <p>Overall: 14" Diameter .75"h</p> <hr/> <p>SMFDT-L \$722 Up & Away w/ Lock & High Pressure Laminate Top. (Specify Laminate / Specify Left Or Right Facing Arm Location)</p> <p>SMFDT-V \$1007 Up & Away w/ Lock & Veneer Top. (Specify Finish / Specify Left Or Right Facing Arm Location)</p> <p>SMFDT-C \$1126 Up & Away w/ Lock & White Solid Surface Top. (Available In White Only / Specify Left Or Right Facing Arm Location)</p> <p>Available: Facelift Evolve 1857</p> | |
| <p>POWER / DATA MODULE</p>  <p>PM1 Power / Data Module</p>  <p>PM2 Power Module</p>  <p>USB-1 Dual Charging USB</p> | <p>PM1 Overall: 5.25"w 1.25"d 4.25"h PM2 Overall: 2"w 2"d .125"h USB-1 Overall: 2"w 2"d .125"h</p> <hr/> <p>PM1 \$859 Power/Data Module (1-Power / 1-USB 2 Port Simplex Charger Standard) Vertical / Horizontal Mount Power Module. Price Varies By Socket. Contact Customer Service For Quote. (Additional Colors Available)</p> <p>PM2 \$238 Power Module (1-Power) Spill-Proof Technology / Multiple Finish Options / Storm Color Standard (Specify Left or Right Facing)</p> <p>USB-1 \$238 Dual Charging USB (2 Port Simplex Charger Standard) Spill-Proof Technology / 2 Amps Per Port / Multiple Finish Options / Storm Color Standard (Specify Left or Right Facing)</p> <p>Available: Facelift Evolve Sleepover Lounge (1845, 1846, 1847 Models)</p> | |
| <p>LOCKING / NON-LOCKING CASTERS</p>  <p>Locking Casters</p>  <p>Non-Locking Casters</p> | <p>Overall: 1.875"w 2.25"d 1.5"h (Locking) / 1.875"w 1.625"d 1.5"h (Non-Locking)</p> <hr/> <p>LC \$44 (Set Of Two) Locking Casters (Black Finish / Specify Location)</p> <p>NLC \$37 (Set Of Two) Non-Locking Casters (Black Finish / Specify Location)</p> <p>Available: Facelift Evolve Sleepover Lounge (1844-1845 Models)</p> | |
| <p>WALLSAVER - LOCKING / NON-LOCKING CASTERS</p>  <p>Locking Casters</p>  <p>Non-Locking Casters</p> | <p>Overall: 2.5"w 4"d 3.5"h (Locking) / 2.5"w 3.25"d 3.5"h (Non-Locking)</p> <hr/> <p>WLC \$199 List (Set Of Two) Locking Swivel Casters (Gray Finish / Back Location)</p> <p>WNLC \$185 List (Set Of Two) Non-Locking / Non-Swivel Casters (Gray Finish / Front Location)</p> <p>Note: Wallsaver Locking / Non-Locking Casters Cannot Be Used In Combination With Electric Recline.</p> <p>Available: Facelift Wallsaver Recliners (1511 / 1811 / 1855 & Bariatric Versions)</p> | |

| CASTERS / BRAKE / LEGS / ELECTRIC / FOLD DOWN ARM | OPTION #: | SPECIFICATIONS LIST PRICES AVAILABILITY: |
|---|--|--|
| MEDICAL LOCKING / NON-LOCKING CASTERS | | |
| <i>Overall: 2.25"w 5"d 5.25"h (Locking) / 2"w 3.75"d 5.25"h (Non-Locking)</i> | | |
|  <p>Locking Casters</p>  <p>Non-Locking Casters</p> | MLC | \$194 (Set Of Two) <i>Locking Casters - Motion & Direction (Gray Finish / Specify Location)</i> |
| | MNLC | \$224 (Set Of Two) <i>Non-Locking Casters - Single Direction (Gray Finish / Specify Location)</i> Available: Facelift Evolve Medical Recliners |
| CENTRAL BRAKING | | |
| <i>Overall: 7.5"w 2"d .5"h</i> | | |
|  | CB-1 | \$508 (Set Of 1) <i>(Gray Plastic Brake w/ Lock & Unlock Pedals)</i> Available: Wallsavers / Infusion 1855 1865 |
| | CB-2 | \$510 (Set Of 1) <i>(Gray Plastic Brake w/ Lock & Unlock Pedals)</i> Available: Layflat 1857 L/T 1867 L/T |
| BRUSHED ALUMINUM ROUND LEGS | | |
| <i>Overall: 2" Diameter 5"h</i> | | |
|  | ARL | \$353 (Set Of 4) <i>(Brushed Aluminum Finish)</i> Available: Facelift Evolve Asynchronous Patient Chair (1852 Model) |
| ELECTRIC RECLINE / BATTERY BACKUP / HEAT / MASSAGE | | |
| <i>Overall: N/A</i> | | |
|  <p>ER-1 Electric Recline (Wallsaver Model)</p>  <p>ER-2/ER-3 Electric Recline (Layflat Model)</p>  <p>HM Heat & Massage (All Recliner Models)</p>  <p>H Heat (All Recliner Models)</p> | ER-1 | \$1054 Electric Recline <i>Replaces Manual Mechanism On Any Wallsaver Model - Surface Mounts On Inside Arm (Specify Left Or Right Facing)</i> *NOTE: ELECTRIC OPTION NOT AVAILABLE ON INFUSION RECLINERS IN COMBINATION WITH CASTERS. |
| | ER-2 | \$1087 Electric Recline <i>Replaces Manual Mechanism On Any Layflat Model - Surface Mounts On Inside Arm (Specify Left Or Right Facing)</i> |
| | ER-3 | \$1149 Electric Recline <i>Replaces Manual Mechanism On Any Trendelenburg Layflat Model - Surface Mounts On Inside Arm (Specify Left Or Right Facing)</i> |
| | BB | \$548 Battery Backup <i>Allows Any Wallsaver, Layflat, Or Standup Electric Recliner To Be Cordless - Surface Mounts On Inside Arm (Specify Left Or Right Facing)</i> |
| | HM | \$1498 Heat & Massage <i>Add Heat & Massage To Any Wallsaver, Layflat, Or Standup Electric Recliner - Surface Mounts On Inside Arm (Specify Left Or Right Facing)</i> |
| H | \$1142 Heat <i>Add Heat Only To Any Wallsaver, Layflat, Or Standup Electric Recliner - Surface Mounts On Inside Arm (Specify Left Or Right Facing)</i> Available: Facelift Evolve Recliners | |

| FOLD DOWN ARM / PUSH BAR / I.V. POLE / SIDE TRAY | OPTION #: | SPECIFICATIONS LIST PRICES AVAILABILITY: |
|---|--|--|
| <p>FOLD DOWN ARM</p>  | <p>FDA-1</p> | <p>Overall: 24"w 2.5"d 10"h</p> <hr/> <p>\$655 Per Arm Piano Hinged Fold Down Arm.</p> <p>Available: Facelift 3 Evolve Wallsaver Recliner (1855 - Right Facing Only), Layflat Medical Recliner (1857 - Right Facing Only) Four Position Recliner(1858 - Left and/or Right Facing) Note: If Two Fold Down Arms (Left & Right) Are Requested On A Recliner, The Electric Wand Must Be Specified.</p> |
| <p>PUSH BAR</p>  | <p>PB</p> | <p>Overall: 18.5"w 3.5"d 1"h</p> <hr/> <p>\$267 (Black Finish)</p> <p>Available: Facelift Evolve Medical Recliners</p> |
| <p>I.V. POLE</p>  | <p>IV</p> | <p>Overall: 10"w 2.5"d 39.5" / 69.75"h</p> <hr/> <p>\$489 Height Adjustable I.V. Pole (Chrome & Black Finish / Specify Left Or Right Facing Location)</p> <p>Available: Facelift Evolve Medical Recliners</p> |
| <p>SIDE TRAY</p>  | <p>ST-1 ST-2 WST</p> | <p>Overall: 12.75"w 10"d 4"h (Small Side Tray) / 17"w 10"d 4"h (Large Side Tray)</p> <hr/> <p>\$368 Drop-Down Side Tray (Small Side Tray) NOTE: Attaches Directly To Outside Of Arm</p> <p>\$415 Drop-Down Side Tray (Large Side Tray) NOTE: Attaches Directly To Outside Of Arm</p> <p>Available: Facelift Replay Medical Recliners Note: If A Medical Recliner With A Manual Mechanism Is Selected, The Standard Side Tray Location Will Be Front Right Facing</p> <p>\$598 Drop-Down Side Tray (Large Side Tray) NOTE: Attaches To Metal Tubing</p> <p>Available: Facelift Wallsaver Recliners With Casters Option (1855)</p> |

| BAG HOLDER / BUCKLE FOOTREST / OXYGEN TANK HOLDER / RING BASE | OPTION #: | SPECIFICATIONS LIST PRICES AVAILABILITY: |
|--|--|--|
| <p>BAG HOLDER / PERSONAL RESTRAINT BUCKLE</p>  | <p>Overall: 2.19"w .38"d 2.56"h</p> <hr/> <p>BH \$86 <i>Bag Holder (Brushed Finish / Specify Left Or Right Facing Location)</i></p> <p>RB \$133 (Set Of 2) <i>Personal Restraint Buckle (Brushed Finish)</i></p> <p>Available: <i>Facelift Evolve Medical Recliners</i> <i>Note: If A Medical Recliner With A Manual Mechanism Is Selected, The Standard Side Tray Location Will Be Front Right Facing</i></p> | |
| <p>FOOTREST</p>  | <p>Overall: 16"w 8"d .1875"h</p> <hr/> <p>FR \$408 <i>(Black Finish)</i></p> <p>Available: <i>Facelift Evolve Medical Recliners</i></p> | |
| <p>OXYGEN TANK HOLDER</p>  | <p>Overall: 4.75" Diameter 9.75"h</p> <hr/> <p>OH \$247 <i>Black Metal Oxygen Tank Holder Holds a 4.375" Diameter Oxygen Tank (Not Included) (Specify Left Or Right Facing Location)</i></p> <p>Available: <i>Facelift Evolve Medical Recliners</i></p> | |
| <p>LOUNGE GLIDER WOOD RING BASE</p>  | <p>Overall: 22"dia. 3"h</p> <hr/> <p>WR \$224 <i>Wood Ring Base replaces circular metal base (1854-G) or swivel glider w/ circular metal base (1854-SG).</i></p> <p><i>Specify Exposed Wood Finish. (See Page 6)</i></p> <p>Available: <i>Facelift Evolve Lounge Glider</i></p> | |

| COVERS / SPRINGS | OPTION #: | SPECIFICATIONS LIST PRICES AVAILABILITY: |
|---|--|--|
| <p>CONTRASTING COVERS</p>  | <p>Overall: N/A</p> <hr/> <p>CC \$129 <i>NOTE: If Two Or More Upholsteries Or Leathers Are Used On Any Piece Of Furniture, Then A Contrast Charge Will Apply Per Order. When Using Trinity Upholstery, The Higher Priced Upholstery Grade Will Be Used In Pricing, Unless It's Trinity Leather With Fabric Contrast Welt, Or COM With Trinity Contrast Welt, Then Contact Customer Service For Pricing.</i></p> <p>Available: <i>Facelift Evolve Healthcare Motion</i></p> | |

Facelift Evolve

HEALTHCARE MOTION
Weight-Activated Medical Recliners

Effective: March 1, 2025

T R I N I T Y

Date:

Page:

Modification:

Description:

DESCRIPTION:

- Upholstery Frames: Plywood, Hardwood & Steel
- Seat: High Density Polyurethane Foam Over Sheet Webbing
- Back: High Density Polyurethane Foam Over Sinuous Wire Springs
- Upholstered Covers: Attached w/ Velcro / Removable For Maintenance
- Antimicrobial Moisture Barrier Fully Encapsulates All Foam Areas
- Double Needle Stitching Standard (Wetling Optional - No Charge)
- Rotational & Directional Locking Casters (Rear)
- Leather Upholstery Not Available
- Lifetime Warranty

OPTIONS:

(See Weight Activated Medical Recliner Options Pages)

Feather Down & Polyester Pillows Available (See Page 5)

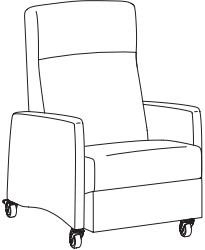
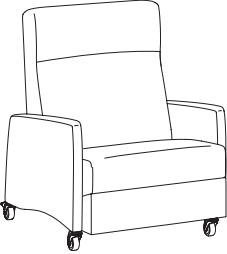
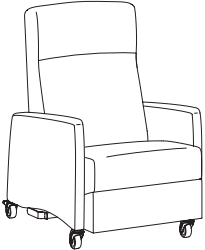
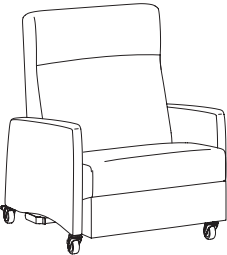
| FULLY UPHOLSTERED ARM | | ITEM #: | SPECIFICATIONS GRADES LIST PRICES: | | | | | | | | | | | | | |
|---|---|---|---|------------|---|----------|----------|----------|--|----------|----------|----------|----------|-----------|-----------|-----------|
|  | THREE POSITION RECLINER / UPHOLSTERED ARM | | Overall: 28.5"w 37"d 47"h Seat: 23.5"w 20"d 20"h | | Arm: 26"h Weight: 140 lbs. | | | | COM: 5.75 yds. COL: n/a | | | | | | | |
| | | | COM | COL | 1 | 2 | 3 | 4 | 5 | 6 | 7 | 8 | 9 | 10 | L1 | L2 |
| | 1858 | | 2826 | N/A | 3039 | 3223 | 3407 | 3590 | 3774 | 3958 | 4142 | 4325 | 4509 | 4693 | N/A | N/A |
| | | <i>Tight Seat & Back / Removable Upholstery / 350 lb. Weight Capacity</i> | | | | | | | | | | | | | | |
| | 1858-R | 360 | N/A | 688 | 862 | 1035 | 1209 | 1383 | 1557 | 1731 | 1905 | 2079 | 2253 | N/A | N/A | |
| | | <i>Replacement Upholstery Covers</i> | | | | | | | | | | | | | | |
|  | BARIATRIC THREE POSITION RECLINER / UPHOLSTERED ARM | | Overall: 33.5"w 37"d 47"h Seat: 28.5"w 20"d 20"h | | Arm: 26"h Weight: 155 lbs. | | | | COM: 5.75 yds. COL: n/a | | | | | | | |
| | | | COM | COL | 1 | 2 | 3 | 4 | 5 | 6 | 7 | 8 | 9 | 10 | L1 | L2 |
| | 1858-X | | 2939 | N/A | 3146 | 3330 | 3513 | 3697 | 3881 | 4065 | 4248 | 4432 | 4616 | 4800 | N/A | N/A |
| | | <i>Tight Seat & Back / Removable Upholstery / 500 lb. Weight Capacity</i> | | | | | | | | | | | | | | |
| | 1858-XR | 366 | N/A | 694 | 868 | 1042 | 1216 | 1389 | 1563 | 1737 | 1911 | 2085 | 2259 | N/A | N/A | |
| | | <i>Replacement Upholstery Covers</i> | | | | | | | | | | | | | | |
|  | TRENDELENBURG FOUR POSITION RECLINER / UPHOLSTERED ARM | | Overall: 28.5"w 37"d 47"h Seat: 23.5"w 20"d 20"h | | Arm: 26"h Weight: 140 lbs. | | | | COM: 5.75 yds. COL: n/a | | | | | | | |
| | | | COM | COL | 1 | 2 | 3 | 4 | 5 | 6 | 7 | 8 | 9 | 10 | L1 | L2 |
| | 1858-T | | 3066 | N/A | 3266 | 3450 | 3634 | 3817 | 4001 | 4185 | 4369 | 4552 | 4736 | 4920 | N/A | N/A |
| | | <i>Tight Seat & Back / Removable Upholstery / 350 lb. Weight Capacity</i> | | | | | | | | | | | | | | |
| | 1858-TR | 360 | N/A | 688 | 862 | 1035 | 1209 | 1383 | 1557 | 1731 | 1905 | 2079 | 2253 | N/A | N/A | |
| | | <i>Replacement Upholstery Covers</i> | | | | | | | | | | | | | | |
|  | BARIATRIC TRENDELENBURG FOUR POSITION RECLINER / UPHOLSTERED ARM | | Overall: 33.5"w 37"d 47"h Seat: 28.5"w 20"d 20"h | | Arm: 26"h Weight: 155 lbs. | | | | COM: 5.75 yds. COL: n/a | | | | | | | |
| | | | COM | COL | 1 | 2 | 3 | 4 | 5 | 6 | 7 | 8 | 9 | 10 | L1 | L2 |
| | 1858-XT | | 3179 | N/A | 3373 | 3557 | 3741 | 3924 | 4108 | 4292 | 4476 | 4659 | 4843 | 5027 | N/A | N/A |
| | | <i>Tight Seat & Back / Removable Upholstery / 500 lb. Weight Capacity</i> | | | | | | | | | | | | | | |
| | 1858-XTR | 366 | N/A | 694 | 868 | 1042 | 1216 | 1389 | 1563 | 1737 | 1911 | 2085 | 2259 | N/A | N/A | |
| | | <i>Replacement Upholstery Covers</i> | | | | | | | | | | | | | | |

DESCRIPTION:

- Upholstery Frames: Plywood, Hardwood & Steel
- Seat: High Density Polyurethane Foam Over Sheet Webbing
- Back: High Density Polyurethane Foam Over Sinuous Wire Springs
- Upholstered Covers: Attached w/ Velcro / Removable For Maintenance
- Antimicrobial Moisture Barrier Fully Encapsulates All Foam Areas
- Double Needle Stitching Standard (Wetling Optional - No Charge)
- Rotational & Directional Locking Casters (Rear)
- Leather Upholstery Not Available
- Lifetime Warranty

OPTIONS:

(See Weight Activated Medical Recliner Options Pages)

Feather Down & Polyester Pillows Available (See Page 5)

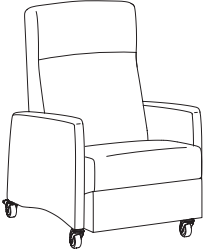
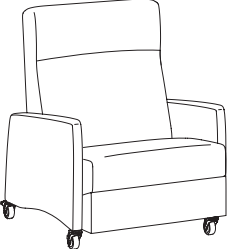
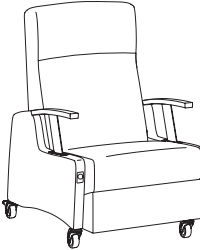
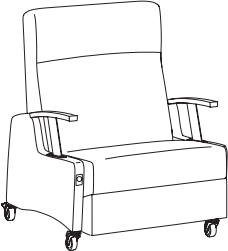
| DROP-DOWN ARM | | ITEM #: | SPECIFICATIONS GRADES LIST PRICES: | | | | | | | | | | | | |
|---|--|---------|--|------------|-------------------------|----------|-----------------------|----------|----------|----------|----------|----------|----------|-----------|-----------|
|  | ELECTRIC MULTI-POSITION RECLINER / UPHOLSTERED ARM | | <i>Overall: 28.5"w 37"d 47"h</i> | | <i>Arm: 26"h</i> | | <i>COM: 5.75 yds.</i> | | | | | | | | |
| | | | <i>Seat: 23.5"w 20"d 20"h</i> | | <i>Weight: 140 lbs.</i> | | <i>COL: n/a</i> | | | | | | | | |
| | | | COM | COL | 1 | 2 | 3 | 4 | 5 | 6 | 7 | 8 | 9 | 10 | L1 |
| | 1868-E | 3826 | N/A | 4039 | 4223 | 4407 | 4590 | 4774 | 4958 | 5142 | 5325 | 5509 | 5693 | N/A | N/A |
| <i>Tight Seat & Back / Removable Upholstery / 350 lb. Weight Capacity</i> | | | | | | | | | | | | | | | |
| | 1868-ER | 360 | N/A | 688 | 862 | 1035 | 1209 | 1383 | 1557 | 1731 | 1905 | 2079 | 2253 | N/A | N/A |
| <i>Replacement Upholstery Covers</i> | | | | | | | | | | | | | | | |
|  | BARIATRIC ELECTRIC MULTI-POSITION RECLINER / UPHOLSTERED ARM | | <i>Overall: 33.5"w 37"d 47"h</i> | | <i>Arm: 26"h</i> | | <i>COM: 5.75 yds.</i> | | | | | | | | |
| | | | <i>Seat: 28.5"w 20"d 20"h</i> | | <i>Weight: 155 lbs.</i> | | <i>COL: n/a</i> | | | | | | | | |
| | | | COM | COL | 1 | 2 | 3 | 4 | 5 | 6 | 7 | 8 | 9 | 10 | L1 |
| | 1868-XE | 3939 | N/A | 4146 | 4330 | 4513 | 4697 | 4881 | 5065 | 5248 | 5432 | 5616 | 5800 | N/A | N/A |
| <i>Tight Seat & Back / Removable Upholstery / 500 lb. Weight Capacity</i> | | | | | | | | | | | | | | | |
| | 1868-XER | 366 | N/A | 694 | 868 | 1042 | 1216 | 1389 | 1563 | 1737 | 1911 | 2085 | 2259 | N/A | N/A |
| <i>Replacement Upholstery Covers</i> | | | | | | | | | | | | | | | |
|  | THREE POSITION RECLINER / DROP-DOWN ARM / URETHANE TASK ARM CAP | | <i>Overall: 28.5"w 37"d 47"h</i> | | <i>Arm: 26"h</i> | | <i>COM: 5.5 yds.</i> | | | | | | | | |
| | | | <i>Seat: 23.5"w 20"d 20"h</i> | | <i>Weight: 125 lbs.</i> | | <i>COL: n/a</i> | | | | | | | | |
| | | | COM | COL | 1 | 2 | 3 | 4 | 5 | 6 | 7 | 8 | 9 | 10 | L1 |
| | 1860 | 4337 | N/A | 4434 | 4601 | 4768 | 4935 | 5102 | 5269 | 5436 | 5603 | 5770 | 5937 | N/A | N/A |
| <i>Tight Seat & Back / Removable Upholstery / 350 lb. Weight Capacity</i> | | | | | | | | | | | | | | | |
| | 1860-R | 348 | N/A | 677 | 850 | 1024 | 1198 | 1372 | 1546 | 1720 | 1894 | 2068 | 2241 | N/A | N/A |
| <i>Replacement Upholstery Covers</i> | | | | | | | | | | | | | | | |
|  | BARIATRIC THREE POSITION RECLINER / DROP-DOWN ARM / URETHANE TASK ARM CAP | | <i>Overall: 33.5"w 37"d 47"h</i> | | <i>Arm: 26"h</i> | | <i>COM: 5.75 yds.</i> | | | | | | | | |
| | | | <i>Seat: 28.5"w 20"d 20"h</i> | | <i>Weight: 140 lbs.</i> | | <i>COL: n/a</i> | | | | | | | | |
| | | | COM | COL | 1 | 2 | 3 | 4 | 5 | 6 | 7 | 8 | 9 | 10 | L1 |
| | 1860-X | 4457 | N/A | 4581 | 4765 | 4949 | 5132 | 5316 | 5500 | 5684 | 5867 | 6051 | 6235 | N/A | N/A |
| <i>Tight Seat & Back / Removable Upholstery / 500 lb. Weight Capacity</i> | | | | | | | | | | | | | | | |
| | 1860-XR | 355 | N/A | 683 | 857 | 1031 | 1205 | 1378 | 1552 | 1726 | 1900 | 2074 | 2248 | N/A | N/A |
| <i>Replacement Upholstery Covers</i> | | | | | | | | | | | | | | | |

WEIGHT-ACTIVATED MEDICAL RECLINER POSITIONS:

Fully Upholstered Arm Recliner Positions

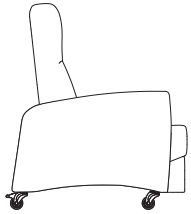

Upright Position
28.5°D

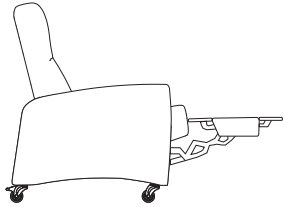

Extended Footrest Position
55.5°D

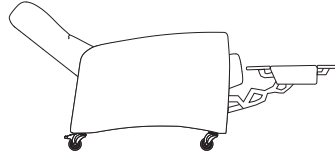

Layflat Position
67°D

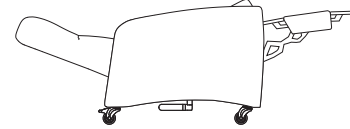

Trendelenburg Position
69°D

Drop-Down Arm Recliner Positions

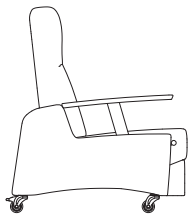

Upright Position
28.5°D

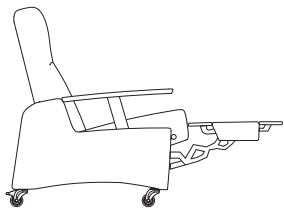

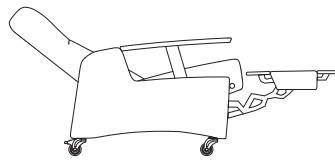

Extended Footrest Position
55.5°D



Layflat Position
67°D

| PUSH BAR / IV / SIDE TRAY / BAG HOLDER / RESTRAINT BUCKLE | OPTION #: | SPECIFICATIONS LIST PRICES AVAILABILITY: |
|---|---|--|
| <p>PUSH BAR</p>  | <p>PB</p> <p>\$267 <i>(Black Finish)</i></p> <p>Available: <i>Facelift Evolve Weight Activated Medical Recliners</i></p> | |
| <p>I.V. POLE</p>  | <p>IV</p> <p>\$489 <i>Height Adjustable I.V. Pole (Chrome / Black Finish)</i></p> <p>Available: <i>Facelift Evolve Weight Activated Medical Recliners</i></p> | |
| <p>SIDE TRAY</p>  | <p>ST-1 \$368 <i>Drop-Down Side Tray (Small Side Tray)</i></p> <p>ST-2 \$415 <i>Drop-Down Side Tray (Large Side Tray)</i></p> <p>Available: <i>Facelift Evolve Weight Activated Medical Recliners</i></p> | |
| <p>BAG HOLDER / PERSONAL RESTRAINT BUCKLE</p>  | <p>BH \$86 <i>Bag Holder (Brushed Finish / Specify Left Or Right Facing Location)</i></p> <p>RB \$133 (Set Of 2) <i>Personal Restraint Buckle (Brushed Finish)</i></p> <p>Available: <i>Facelift Evolve Weight Activated Medical Recliners</i></p> | |

| OXYGEN TANK HOLDER / ARM CAPS / CASTERS | OPTION #: | SPECIFICATIONS LIST PRICES AVAILABILITY: |
|--|---|---|
| <p>OXYGEN TANK HOLDER</p>  | <p>OH</p> | <p>Overall: 4.75" Diameter 9.75"h</p> <hr/> <p>\$247 Black Metal Oxygen Tank Holder Holds a 4.375" Diameter Oxygen Tank (Not Included)</p> <p>Available: Facelift Evolve Weight Activated Medical Recliners</p> |
| <p>SOLID WOOD / URETHANE ARM CAPS</p>   | <p>EWAC-1</p> <p>EUAC-1</p> | <p>Overall: 2.75"w 29"d 1.125"h</p> <hr/> <p>\$243 (Set Of 2) WOOD (Specify Finish)</p> <p>Available: 1858 Models Only</p> <hr/> <p>\$249 (Set Of 2) URETHANE (Black Urethane)</p> <p>Available: 1858 Models Only</p> |
| <p>POLYESTER ARM CAPS</p>   | <p>EPAC-1</p> <p>EPAC-2</p> | <p>Overall: 2.75"w 22.5"d 1.125"h (EPAC-1) / 2.75"w 29"d 1.125"h (EPAC-2)</p> <hr/> <p>\$374 (Set Of 2) POLYESTER (1860-U / 1860-XU / 1860-TU / 1860-XTU)</p> <p>Black Polyester Arm Cap (Additional Colors Available)</p> <hr/> <p>\$393 (Set Of 2) POLYESTER (1858 / 1858-X / 1858-T / 1858-XT) (1859-U / 1859-XU / 1859-TU / 1859-XTU) (1859N-U / 1859N-XU / 1859N-TU / 1859N-XTU)</p> <p>Black Polyester Arm Cap (Additional Colors Available)</p> |
| <p>MEDICAL LOCKING / NON-LOCKING CASTERS</p>   <p>Locking Casters</p> <p>Non-Locking Casters</p> | <p>MLC</p> <p>MNLC</p> | <p>Overall: 2.25"w 5"d 5.25"h (Locking) / 2"w 3.75"d 5.25"h (Non-Locking)</p> <hr/> <p>\$194 (Set Of Two) Locking Casters - Motion & Direction (Gray Finish / Specify Location)</p> <p>\$224 (Set Of Two) Non-Locking Casters - Single Direction (Gray Finish / Specify Location)</p> <p>Available: Facelift Evolve Weight Activated Medical Recliners</p> |

| COVERS | OPTION #: | SPECIFICATIONS LIST PRICES AVAILABILITY: |
|---|---|--|
| <p>CONTRASTING COVERS</p>  | <p>Overall: N/A</p> <hr/> <p>CC \$129 <i>NOTE: If Two Or More Upholsteries Or Leathers Are Used On Any Piece Of Furniture, Then A Contrast Charge Will Apply Per Order. When Using Trinity Upholstery, The Higher Priced Upholstery Grade Will Be Used In Pricing, Unless It's Trinity Leather With Fabric Contrast Welt, Or COM With Trinity Contrast Welt, Then Contact Customer Service For Pricing.</i></p> <p>Available: <i>Facelift Evolve Weight Activated Medical Recliners</i></p> | |

Facelift Evolve

LOUNGE / TANDEM

Effective: March 1, 2025

T R I N I T Y

Date:

Page:

Modification:

Description:

DESCRIPTION:

- Upholstery Frames: Steel, Plywood & Hardwood
- Seat: High Density Polyurethane Foam Over Strap Webbing
- Back: High Density Polyurethane Foam Over Sinuous Wire Springs
- Upholstered Covers: Attached w/ Velcro / Removable For Maintenance
- Exposed Wood Legs: Solid Hardwood / Removable For Maintenance
- Antimicrobial Moisture Barrier Fully Encapsulates All Foam Areas
- Leather Upholstery Not Available
- Lifetime Warranty

OPTIONS:

- EWAC Solid Wood Arm Caps (Set Of 2)\$243
 - EUAC Black Urethane Arm Caps (Set Of 2).....\$249
 - EPAC-2 Black Polyester Arm Caps (Set Of 2).....\$374
 - ARL Brushed Aluminum Round Legs (Set Of 4).....\$353
 - PM1 Power/Data Module (1-Power / 1-USB 2 Port Simplex Charger)\$859
- (Additional Power/Data Modules Available - See Evolve Options)
- Feather Down & Polyester Pillows Available (See Page 5)
 Specify Exposed Wood Finish (See Page 6)
 Tablet Arm / Cup Holder Options (See Facelift Evolve Lounge / Tandem Options Pages)
- NOTE: All Seating Configurations Are Viewed From Left To Right Facing. Please Attach A Layout Showing Seating Configuration w/ Your Order. Assembled Units Must Be Shipped In Configurations Of 3 Or Less.*

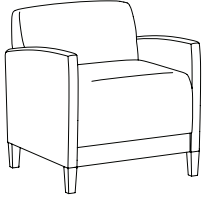
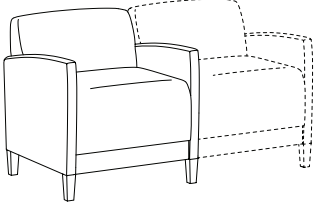
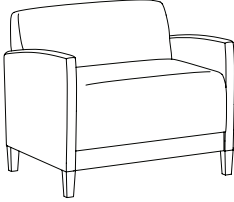
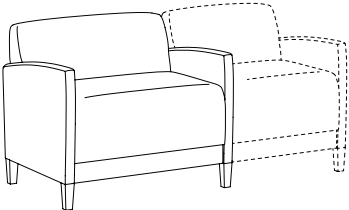
| LOUNGE / TANDEM | | ITEM #: | SPECIFICATIONS GRADES LIST PRICES: | | | | | | | | | | | | | |
|---|--|---------|--|-----|-------------------------|------|------|------|----------------------|------|------|------|------|------|-----|-----|
|  | | 1841 | Overall: 28"w 29"d 31.5"h | | Arm: 24.5"h | | | | COM: 4.5 yds. | | | | | | | |
| | | | Seat: 23.5"w 19"d 18.5"h | | Weight: 85 lbs. | | | | COL: n/a | | | | | | | |
| | | | COM | COL | 1 | 2 | 3 | 4 | 5 | 6 | 7 | 8 | 9 | 10 | L1 | L2 |
| | | | 1622 | N/A | 1779 | 1902 | 2024 | 2147 | 2270 | 2392 | 2515 | 2638 | 2760 | 2883 | N/A | N/A |
| | | | <i>Tight Seat & Back / Removable Upholstery / 500 lb. Weight Capacity</i> | | | | | | | | | | | | | |
| | | 1841-R | 251 | N/A | 491 | 617 | 744 | 870 | 996 | 1123 | 1249 | 1376 | 1502 | 1629 | N/A | N/A |
| | | | <i>Replacement Upholstery Covers</i> | | | | | | | | | | | | | |
|  | | 1841-C | Overall: 28"w 29"d 31.5"h | | Arm: 24.5"h | | | | COM: 4.5 yds. | | | | | | | |
| | | | Seat: 23.5"w 19"d 18.5"h | | Weight: 85 lbs. | | | | COL: n/a | | | | | | | |
| | | | COM | COL | 1 | 2 | 3 | 4 | 5 | 6 | 7 | 8 | 9 | 10 | L1 | L2 |
| | | | 1622 | N/A | 1779 | 1902 | 2024 | 2147 | 2270 | 2392 | 2515 | 2638 | 2760 | 2883 | N/A | N/A |
| | | | <i>Tight Seat & Back / Removable Upholstery / 500 lb. Weight Capacity</i> | | | | | | | | | | | | | |
| | | 1841-R | 251 | N/A | 491 | 617 | 744 | 870 | 996 | 1123 | 1249 | 1376 | 1502 | 1629 | N/A | N/A |
| | | | <i>Replacement Upholstery Covers</i> | | | | | | | | | | | | | |
|  | | 1841-X | Overall: 34"w 29"d 31.5"h | | Arm: 24.5"h | | | | COM: 5 yds. | | | | | | | |
| | | | Seat: 29.5"w 19"d 18.5"h | | Weight: 100 lbs. | | | | COL: n/a | | | | | | | |
| | | | COM | COL | 1 | 2 | 3 | 4 | 5 | 6 | 7 | 8 | 9 | 10 | L1 | L2 |
| | | | 1970 | N/A | 2137 | 2274 | 2411 | 2548 | 2685 | 2823 | 2960 | 3097 | 3234 | 3371 | N/A | N/A |
| | | | <i>Tight Seat & Back / Removable Upholstery / 1000 lb. Weight Capacity</i> | | | | | | | | | | | | | |
| | | 1841-XR | 258 | N/A | 529 | 671 | 813 | 955 | 1098 | 1240 | 1382 | 1524 | 1667 | 1809 | N/A | N/A |
| | | | <i>Replacement Upholstery Covers</i> | | | | | | | | | | | | | |
|  | | 1841-XC | Overall: 34"w 29"d 31.5"h | | Arm: 24.5"h | | | | COM: 5 yds. | | | | | | | |
| | | | Seat: 29.5"w 19"d 18.5"h | | Weight: 100 lbs. | | | | COL: n/a | | | | | | | |
| | | | COM | COL | 1 | 2 | 3 | 4 | 5 | 6 | 7 | 8 | 9 | 10 | L1 | L2 |
| | | | 1970 | N/A | 2137 | 2274 | 2411 | 2548 | 2685 | 2823 | 2960 | 3097 | 3234 | 3371 | N/A | N/A |
| | | | <i>Tight Seat & Back / Removable Upholstery / 1000 lb. Weight Capacity</i> | | | | | | | | | | | | | |
| | | 1841-XR | 258 | N/A | 529 | 671 | 813 | 955 | 1098 | 1240 | 1382 | 1524 | 1667 | 1809 | N/A | N/A |
| | | | <i>Replacement Upholstery Covers</i> | | | | | | | | | | | | | |

DESCRIPTION:

- Upholstery Frames: Steel, Plywood & Hardwood
- Seat: High Density Polyurethane Foam Over Strap Webbing
- Back: High Density Polyurethane Foam Over Sinuous Wire Springs
- Upholstered Covers: Attached w/ Velcro / Removable For Maintenance
- Exposed Wood Legs: Solid Hardwood / Removable For Maintenance
- Antimicrobial Moisture Barrier Fully Encapsulates All Foam Areas
- Leather Upholstery Not Available
- Lifetime Warranty

OPTIONS:

- EWAC Solid Wood Arm Caps (Set Of 2)\$243
 - EUAC Black Urethane Arm Caps (Set Of 2).....\$249
 - EPAC-2 Black Polyester Arm Caps (Set Of 2).....\$374
 - ARL Brushed Aluminum Round Legs (Set Of 4).....\$353
 - PM1 Power/Data Module (1-Power / 1-USB 2 Port Simplex Charger)\$859
- (Additional Power/Data Modules Available - See Evolve Options)

Feather Down & Polyester Pillows Available (See Page 5)
 Specify Exposed Wood Finish (See Page 6)
 Tablet Arm / Cup Holder Options (See Facelift Evolve Lounge / Tandem Options Pages)
NOTE: All Seating Configurations Are Viewed From Left To Right Facing. Please Attach A Layout Showing Seating Configuration w/ Your Order. Assembled Units Must Be Shipped In Configurations Of 3 Or Less.

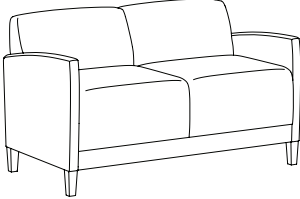
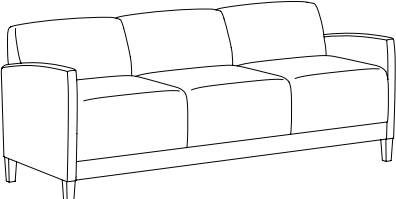
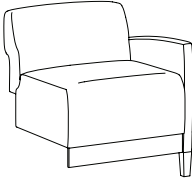
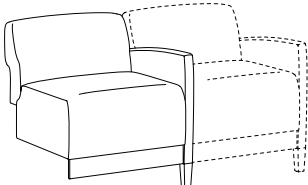
| LOUNGE / TANDEM | | ITEM #: | SPECIFICATIONS GRADES LIST PRICES: | | | | | | | | | | | | |
|---|--|--|--|------------|----------|----------|-------------------------|----------|----------|----------|-----------------------|----------|----------|-----------|-----------|
|  | TWO PLACE SOFA / FULLY UPHOLSTERED | | <i>Overall: 52"w 29"d 31.5"h</i> | | | | <i>Arm: 24.5"h</i> | | | | <i>COM: 6.75 yds.</i> | | | | |
| | | | <i>Seat: 47.5"w 19"d 18.5"h</i> | | | | <i>Weight: 135 lbs.</i> | | | | <i>COL: n/a</i> | | | | |
| | | | COM | COL | 1 | 2 | 3 | 4 | 5 | 6 | 7 | 8 | 9 | 10 | L1 |
| | 1842 | 2531 | N/A | 2768 | 2956 | 3144 | 3331 | 3519 | 3706 | 3894 | 4082 | 4269 | 4457 | N/A | N/A |
| | 1842-R | 373 | N/A | 764 | 969 | 1175 | 1380 | 1586 | 1791 | 1997 | 2202 | 2407 | 2613 | N/A | N/A |
| | | <i>Tight Seat & Back / Removable Upholstery / 1000 lb. Weight Capacity</i> | | | | | | | | | | | | | |
| | | <i>Replacement Upholstery Covers</i> | | | | | | | | | | | | | |
|  | THREE PLACE SOFA / FULLY UPHOLSTERED | | <i>Overall: 76"w 29"d 31.5"h</i> | | | | <i>Arm: 24.5"h</i> | | | | <i>COM: 8.5 yds.</i> | | | | |
| | | | <i>Seat: 71.5"w 19"d 18.5"h</i> | | | | <i>Weight: 180 lbs.</i> | | | | <i>COL: n/a</i> | | | | |
| | | | COM | COL | 1 | 2 | 3 | 4 | 5 | 6 | 7 | 8 | 9 | 10 | L1 |
| | 1843 | 3440 | N/A | 3728 | 3967 | 4205 | 4443 | 4681 | 4919 | 5157 | 5395 | 5633 | 5872 | N/A | N/A |
| | 1843-R | 481 | N/A | 992 | 1261 | 1530 | 1798 | 2067 | 2336 | 2604 | 2873 | 3142 | 3411 | N/A | N/A |
| | | <i>Tight Seat & Back / Removable Upholstery / 1000 lb. Weight Capacity</i> | | | | | | | | | | | | | |
| | | <i>Replacement Upholstery Covers</i> | | | | | | | | | | | | | |
|  | FULLY UPHOLSTERED / ADD-A-SEAT | | <i>Overall: 26"w 29"d 31.5"h</i> | | | | <i>Arm: 24.5"h</i> | | | | <i>COM: 4.25 yds.</i> | | | | |
| | | | <i>Seat: 23.5"w 19"d 18.5"h</i> | | | | <i>Weight: 65 lbs.</i> | | | | <i>COL: n/a</i> | | | | |
| | | | COM | COL | 1 | 2 | 3 | 4 | 5 | 6 | 7 | 8 | 9 | 10 | L1 |
| | 1844 | 1325 | N/A | 1469 | 1577 | 1686 | 1794 | 1902 | 2010 | 2119 | 2227 | 2335 | 2443 | N/A | N/A |
| | 1844-R | 207 | N/A | 401 | 504 | 606 | 709 | 812 | 915 | 1017 | 1120 | 1223 | 1326 | N/A | N/A |
| | | <i>Tight Seat & Back / Removable Upholstery / 500 lb. Weight Capacity</i> | | | | | | | | | | | | | |
| | | <i>Replacement Upholstery Covers</i> | | | | | | | | | | | | | |
|  | LOUNGE CHAIR / FULLY UPHOLSTERED / ADD-A-SEAT / ACCEPTS SEAT ON RIGHT | | <i>Overall: 26"w 29"d 31.5"h</i> | | | | <i>Arm: 24.5"h</i> | | | | <i>COM: 4.25 yds.</i> | | | | |
| | | | <i>Seat: 23.5"w 19"d 18.5"h</i> | | | | <i>Weight: 65 lbs.</i> | | | | <i>COL: n/a</i> | | | | |
| | | | COM | COL | 1 | 2 | 3 | 4 | 5 | 6 | 7 | 8 | 9 | 10 | L1 |
| | 1844-C | 1325 | N/A | 1469 | 1577 | 1686 | 1794 | 1902 | 2010 | 2119 | 2227 | 2335 | 2443 | N/A | N/A |
| | 1844-CR | 207 | N/A | 401 | 504 | 606 | 709 | 812 | 915 | 1017 | 1120 | 1223 | 1326 | N/A | N/A |
| | | <i>Tight Seat & Back / Removable Upholstery / 500 lb. Weight Capacity</i> | | | | | | | | | | | | | |
| | | <i>Replacement Upholstery Covers</i> | | | | | | | | | | | | | |

DESCRIPTION:

- Upholstery Frames: Steel, Plywood & Hardwood
- Seat: High Density Polyurethane Foam Over Strap Webbing
- Back: High Density Polyurethane Foam Over Sinuous Wire Springs
- Upholstered Covers: Attached w/ Velcro / Removable For Maintenance
- Exposed Wood Arms: Solid Hardwood / Removable For Maintenance
- Antimicrobial Moisture Barrier Fully Encapsulates All Foam Areas
- Leather Upholstery Not Available
- Lifetime Warranty

OPTIONS:

- EWAC Solid Wood Arm Caps (Set Of 2)\$243
 - EUAC Black Urethane Arm Caps (Set Of 2).....\$249
 - EPAC-2 Black Polyester Arm Caps (Set Of 2).....\$374
 - ARL Brushed Aluminum Round Legs (Set Of 4).....\$353
 - PM1 Power/Data Module (1-Power / 1-USB 2 Port Simplex Charger)\$859
- (Additional Power/Data Modules Available - See Evolve Options)

Feather Down & Polyester Pillows Available (See Page 5)
 Specify Exposed Wood Finish (See Page 6)
 Tablet Arm / Cup Holder Options (See Facelift Evolve Lounge / Tandem Options Pages)
NOTE: All Seating Configurations Are Viewed From Left To Right Facing. Please Attach A Layout Showing Seating Configuration w/ Your Order. Assembled Units Must Be Shipped In Configurations Of 3 Or Less.

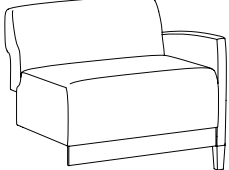
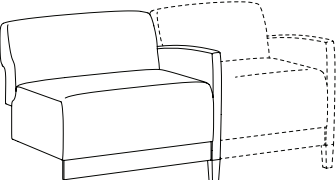
| LOUNGE / TANDEM | | ITEM #: | SPECIFICATIONS GRADES LIST PRICES: | | | | | | | | | | | | | |
|--|--|---|---|------------|----------|--|----------|----------|---|----------|----------|----------|----------|-----------|-----------|-----------|
|  | | BARIATRIC ADD-A-SEAT / FULLY UPHOLSTERED | Overall: 32"w 29"d 31.5"h Seat: 29.5"w 19"d 18.5"h | | | Arm: 24.5"h Weight: 80 lbs. | | | COM: 4.5 yds. COL: n/a | | | | | | | |
| | | | COM | COL | 1 | 2 | 3 | 4 | 5 | 6 | 7 | 8 | 9 | 10 | L1 | L2 |
| | | | 1844-X | 1652 | N/A | 1778 | 1886 | 1995 | 2103 | 2211 | 2319 | 2427 | 2536 | 2644 | 2752 | N/A |
| <i>Tight Seat & Back / Removable Upholstery / 1000 lb. Weight Capacity</i> | | | | | | | | | | | | | | | | |
| 1844-XR <i>Replacement Upholstery Covers</i> | | | | | | | | | | | | | | | | |
|  | | BARIATRIC ADD-A-SEAT / FULLY UPHOLSTERED / ACCEPTS SEAT ON RIGHT | Overall: 32"w 29"d 31.5"h Seat: 29.5"w 19"d 18.5"h | | | Arm: 24.5"h Weight: 80 lbs. | | | COM: 4.5 yds. COL: n/a | | | | | | | |
| | | | COM | COL | 1 | 2 | 3 | 4 | 5 | 6 | 7 | 8 | 9 | 10 | L1 | L2 |
| | | | 1844-XC | 1652 | N/A | 1778 | 1886 | 1995 | 2103 | 2211 | 2319 | 2427 | 2536 | 2644 | 2752 | N/A |
| <i>Tight Seat & Back / Removable Upholstery / 1000 lb. Weight Capacity</i> | | | | | | | | | | | | | | | | |
| 1844-XR <i>Replacement Upholstery Covers</i> | | | | | | | | | | | | | | | | |

DESCRIPTION:

- Upholstery Frames: Steel, Plywood & Hardwood
- Seat: High Density Polyurethane Foam Over Strap Webbing
- Back: High Density Polyurethane Foam Over Sinuous Wire Springs
- Upholstered Covers: Attached w/ Velcro / Removable For Maintenance
- Exposed Wood Arms: Solid Hardwood / Removable For Maintenance
- Antimicrobial Moisture Barrier Fully Encapsulates All Foam Areas
- Leather Upholstery Not Available
- Lifetime Warranty

OPTIONS:

- Closed Arm Panels (1861-PL / 1861-PR / 1861-PC)..... CALL FOR PRICING
- Feather Down & Polyester Pillows Available (See Page 5)
- Specify Exposed Wood Finish (See Page 6)

NOTE: All Seating Configurations Are Viewed From Left To Right Facing. Please Attach A Layout Showing Seating Configuration w/ Your Order. Assembled Units Must Be Shipped In Configurations Of 3 Or Less.

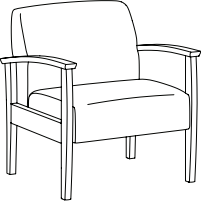
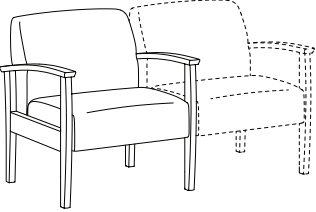
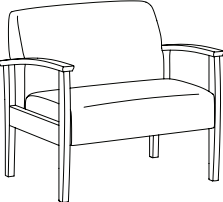
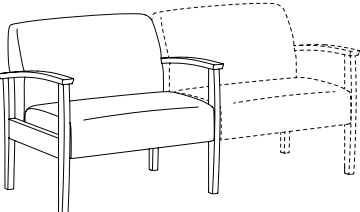
| OPEN ARM LOUNGE / TANDEM | | ITEM #: | SPECIFICATIONS GRADES LIST PRICES: | | | | | | | | | | | | | |
|---|---|---------|--|-----|---|--|---|---|---|---|---|---|---|----|----|----|
|  | LOUNGE CHAIR / OPEN WOOD ARMS | | Overall: 28.5"w 29.5"d 32"h Seat: 24"w 19.5"d 18.5"h | | | Arm: 24.5"h Weight: 65 lbs. | | | COM: 2.5 yds. COL: n/a | | | | | | | |
| | 1861 | | COM | COL | 1 | 2 | 3 | 4 | 5 | 6 | 7 | 8 | 9 | 10 | L1 | L2 |
| | 1861-R | | 1575 N/A 1619 1684 1749 1814 1879 1944 2009 2074 2139 2203 N/A N/A <i>Tight Seat & Back / Removable Upholstery / 500 lb. Weight Capacity</i> 190 N/A 322 393 464 535 606 677 748 820 891 962 N/A N/A <i>Replacement Upholstery Covers</i> | | | | | | | | | | | | | |
|  | LOUNGE CHAIR / OPEN WOOD ARMS / ACCEPTS SEAT ON RIGHT | | Overall: 28.5"w 29.5"d 32"h Seat: 24"w 19.5"d 18.5"h | | | Arm: 24.5"h Weight: 65 lbs. | | | COM: 2.5 yds. COL: n/a | | | | | | | |
| | 1861-C | | COM | COL | 1 | 2 | 3 | 4 | 5 | 6 | 7 | 8 | 9 | 10 | L1 | L2 |
| | 1861-R | | 1575 N/A 1619 1684 1749 1814 1879 1944 2009 2074 2139 2203 N/A N/A <i>Tight Seat & Back / Removable Upholstery / 500 lb. Weight Capacity</i> 190 N/A 322 393 464 535 606 677 748 820 891 962 N/A N/A <i>Replacement Upholstery Covers</i> | | | | | | | | | | | | | |
|  | BARIATRIC LOUNGE CHAIR / OPEN WOOD ARMS | | Overall: 34.5"w 29.5"d 32"h Seat: 30"w 19.5"d 18.5"h | | | Arm: 24.5"h Weight: 80 lbs. | | | COM: 3 yds. COL: n/a | | | | | | | |
| | 1861-X | | COM | COL | 1 | 2 | 3 | 4 | 5 | 6 | 7 | 8 | 9 | 10 | L1 | L2 |
| | 1861-XR | | 1899 N/A 1954 2033 2113 2192 2271 2351 2430 2509 2589 2668 N/A N/A <i>Tight Seat & Back / Removable Upholstery / 750 lb. Weight Capacity</i> 196 N/A 360 446 533 620 707 794 881 968 1055 1142 N/A N/A <i>Replacement Upholstery Covers</i> | | | | | | | | | | | | | |
|  | BARIATRIC LOUNGE CHAIR / OPEN WOOD ARMS / ACCEPTS SEAT ON RIGHT | | Overall: 34.5"w 29.5"d 32"h Seat: 30"w 19.5"d 18.5"h | | | Arm: 24.5"h Weight: 80 lbs. | | | COM: 3 yds. COL: n/a | | | | | | | |
| | 1861-XC | | COM | COL | 1 | 2 | 3 | 4 | 5 | 6 | 7 | 8 | 9 | 10 | L1 | L2 |
| | 1861-XR | | 1899 N/A 1954 2033 2113 2192 2271 2351 2430 2509 2589 2668 N/A N/A <i>Tight Seat & Back / Removable Upholstery / 750 lb. Weight Capacity</i> 196 N/A 360 446 533 620 707 794 881 968 1055 1142 N/A N/A <i>Replacement Upholstery Covers</i> | | | | | | | | | | | | | |

DESCRIPTION:

- Upholstery Frames: Steel, Plywood & Hardwood
- Seat: High Density Polyurethane Foam Over Strap Webbing
- Back: High Density Polyurethane Foam Over Sinuous Wire Springs
- Upholstered Covers: Attached w/ Velcro / Removable For Maintenance
- Exposed Wood Arms: Solid Hardwood / Removable For Maintenance
- Antimicrobial Moisture Barrier Fully Encapsulates All Foam Areas
- Leather Upholstery Not Available
- Lifetime Warranty

OPTIONS:

Closed Arm Panels (1861-PL / 1861-PR / 1861-PC)..... CALL FOR PRICING

Feather Down & Polyester Pillows Available (See Page 5)
Specify Exposed Wood Finish (See Page 6)

NOTE: All Seating Configurations Are Viewed From Left To Right Facing. Please Attach A Layout Showing Seating Configuration w/ Your Order. Assembled Units Must Be Shipped In Configurations Of 3 Or Less.

OPEN ARM LOUNGE / TANDEM

ITEM #:

SPECIFICATIONS | GRADES | LIST PRICES:

TWO PLACE SOFA / OPEN WOOD ARMS

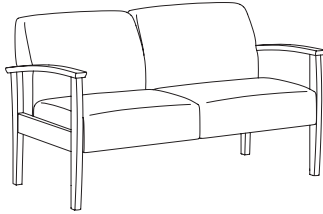

Overall: 52.5"w 29.5"d 32"h **Arm:** 24.5"h **COM:** 4.75 yds.
Seat: 48"w 19.5"d 18.5"h **Weight:** 140 lbs. **COL:** n/a

| COM | COL | 1 | 2 | 3 | 4 | 5 | 6 | 7 | 8 | 9 | 10 | L1 | L2 |
|---|-----|------|------|------|------|------|------|------|------|------|------|-----|-----|
| 1862 | N/A | 2583 | 2713 | 2843 | 2973 | 3102 | 3232 | 3362 | 3492 | 3622 | 3752 | N/A | N/A |
| <i>Tight Seat & Back / Removable Upholstery / 750 lb. Weight Capacity</i> | | | | | | | | | | | | | |
| 1862-R | N/A | 563 | 705 | 847 | 989 | 1132 | 1274 | 1416 | 1558 | 1701 | 1843 | N/A | N/A |
| <i>Replacement Upholstery Covers</i> | | | | | | | | | | | | | |

THREE PLACE SOFA / OPEN WOOD ARMS

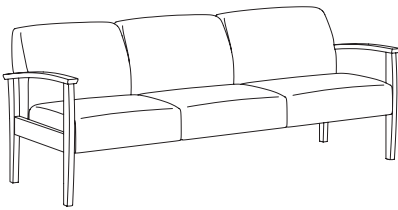

Overall: 76.5"w 29.5"d 32"h **Arm:** 24.5"h **COM:** 7 yds.
Seat: 72"w 19.5"d 18.5"h **Weight:** 180 lbs. **COL:** n/a

| COM | COL | 1 | 2 | 3 | 4 | 5 | 6 | 7 | 8 | 9 | 10 | L1 | L2 |
|---|-----|------|------|------|------|------|------|------|------|------|------|-----|-----|
| 1863 | N/A | 3278 | 3473 | 3668 | 3863 | 4058 | 4252 | 4447 | 4642 | 4837 | 5032 | N/A | N/A |
| <i>Tight Seat & Back / Removable Upholstery / 750 lb. Weight Capacity</i> | | | | | | | | | | | | | |
| 1863-R | N/A | 788 | 1001 | 1215 | 1428 | 1641 | 1855 | 2068 | 2281 | 2495 | 2708 | N/A | N/A |
| <i>Replacement Upholstery Covers</i> | | | | | | | | | | | | | |

ADD-A-SEAT / OPEN WOOD ARMS

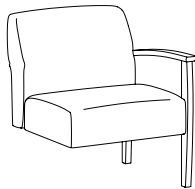

Overall: 26.5"w 29.5"d 32"h **Arm:** 24.5"h **COM:** 2.5 yds.
Seat: 24"w 19.5"d 18.5"h **Weight:** 60 lbs. **COL:** n/a

| COM | COL | 1 | 2 | 3 | 4 | 5 | 6 | 7 | 8 | 9 | 10 | L1 | L2 |
|---|-----|------|------|------|------|------|------|------|------|------|------|-----|-----|
| 1864 | N/A | 1322 | 1387 | 1452 | 1517 | 1582 | 1647 | 1712 | 1777 | 1842 | 1907 | N/A | N/A |
| <i>Tight Seat & Back / Removable Upholstery / 500 lb. Weight Capacity</i> | | | | | | | | | | | | | |
| 1864-R | N/A | 322 | 393 | 464 | 535 | 606 | 677 | 748 | 820 | 891 | 962 | N/A | N/A |
| <i>Replacement Upholstery Covers</i> | | | | | | | | | | | | | |

ADD-A-SEAT / OPEN WOOD ARMS / ACCEPTS SEAT ON RIGHT

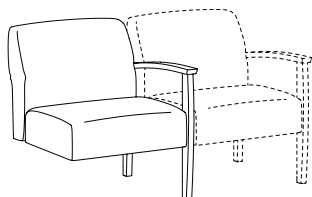

Overall: 26.5"w 29.5"d 32"h **Arm:** 24.5"h **COM:** 2.5 yds.
Seat: 24"w 19.5"d 18.5"h **Weight:** 60 lbs. **COL:** n/a

| COM | COL | 1 | 2 | 3 | 4 | 5 | 6 | 7 | 8 | 9 | 10 | L1 | L2 |
|---|-----|------|------|------|------|------|------|------|------|------|------|-----|-----|
| 1864-C | N/A | 1322 | 1387 | 1452 | 1517 | 1582 | 1647 | 1712 | 1777 | 1842 | 1907 | N/A | N/A |
| <i>Tight Seat & Back / Removable Upholstery / 500 lb. Weight Capacity</i> | | | | | | | | | | | | | |
| 1864-R | N/A | 322 | 393 | 464 | 535 | 606 | 677 | 748 | 820 | 891 | 962 | N/A | N/A |
| <i>Replacement Upholstery Covers</i> | | | | | | | | | | | | | |

DESCRIPTION:

- Upholstery Frames: Steel, Plywood & Hardwood
- Seat: High Density Polyurethane Foam Over Strap Webbing
- Back: High Density Polyurethane Foam Over Sinuous Wire Springs
- Upholstered Covers: Attached w/ Velcro / Removable For Maintenance
- Exposed Wood Arms: Solid Hardwood / Removable For Maintenance
- Antimicrobial Moisture Barrier Fully Encapsulates All Foam Areas
- Leather Upholstery Not Available
- Lifetime Warranty

OPTIONS:

- Closed Arm Panels (1861-PL / 1861-PR / 1861-PC)..... CALL FOR PRICING
- Feather Down & Polyester Pillows Available (See Page 5)
- Specify Exposed Wood Finish (See Page 6)

NOTE: All Seating Configurations Are Viewed From Left To Right Facing. Please Attach A Layout Showing Seating Configuration w/ Your Order. Assembled Units Must Be Shipped In Configurations Of 3 Or Less.

OPEN ARM LOUNGE / TANDEM

ITEM #:

SPECIFICATIONS | GRADES | LIST PRICES:

BARIATRIC ADD-A-SEAT / OPEN WOOD ARMS

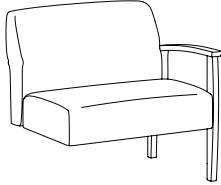

Overall: 32.5"w 29.5"d 32"h **Arm:** 24.5"h **COM:** 3 yds.
Seat: 30"w 19.5"d 18.5"h **Weight:** 75 lbs. **COL:** n/a

| COM | COL | 1 | 2 | 3 | 4 | 5 | 6 | 7 | 8 | 9 | 10 | L1 | L2 |
|-----|-----|---|---|---|---|---|---|---|---|---|----|----|----|
|-----|-----|---|---|---|---|---|---|---|---|---|----|----|----|

1864-X

| | | | | | | | | | | | | | |
|------|-----|------|------|------|------|------|------|------|------|------|------|-----|-----|
| 1597 | N/A | 1669 | 1748 | 1827 | 1907 | 1986 | 2065 | 2145 | 2224 | 2304 | 2383 | N/A | N/A |
|------|-----|------|------|------|------|------|------|------|------|------|------|-----|-----|

Tight Seat & Back / Removable Upholstery / 750 lb. Weight Capacity

1864-XR

| | | | | | | | | | | | | | |
|-----|-----|-----|-----|-----|-----|-----|-----|-----|-----|------|------|-----|-----|
| 196 | N/A | 360 | 446 | 533 | 620 | 707 | 794 | 881 | 968 | 1055 | 1142 | N/A | N/A |
|-----|-----|-----|-----|-----|-----|-----|-----|-----|-----|------|------|-----|-----|

Replacement Upholstery Covers

BARIATRIC ADD-A-SEAT / OPEN WOOD ARMS / ACCEPTS SEAT ON RIGHT

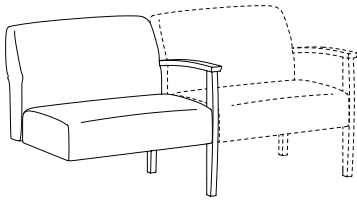

Overall: 32.5"w 29.5"d 32"h **Arm:** 24.5"h **COM:** 3 yds.
Seat: 30"w 19.5"d 18.5"h **Weight:** 75 lbs. **COL:** n/a

| COM | COL | 1 | 2 | 3 | 4 | 5 | 6 | 7 | 8 | 9 | 10 | L1 | L2 |
|-----|-----|---|---|---|---|---|---|---|---|---|----|----|----|
|-----|-----|---|---|---|---|---|---|---|---|---|----|----|----|

1864-XC

| | | | | | | | | | | | | | |
|------|-----|------|------|------|------|------|------|------|------|------|------|-----|-----|
| 1597 | N/A | 1669 | 1748 | 1827 | 1907 | 1986 | 2065 | 2145 | 2224 | 2304 | 2383 | N/A | N/A |
|------|-----|------|------|------|------|------|------|------|------|------|------|-----|-----|

Tight Seat & Back / Removable Upholstery / 750 lb. Weight Capacity

1864-XR

| | | | | | | | | | | | | | |
|-----|-----|-----|-----|-----|-----|-----|-----|-----|-----|------|------|-----|-----|
| 196 | N/A | 360 | 446 | 533 | 620 | 707 | 794 | 881 | 968 | 1055 | 1142 | N/A | N/A |
|-----|-----|-----|-----|-----|-----|-----|-----|-----|-----|------|------|-----|-----|

Replacement Upholstery Covers

DESCRIPTION:

- Upholstery Frames: Steel, Plywood & Hardwood
- Seat: High Density Polyurethane Foam Over Strap Webbing
- Back: High Density Polyurethane Foam Over Sinuous Wire Springs
- Upholstered Covers: Attached w/ Velcro / Removable For Maintenance
- Exposed Wood Arms: Solid Hardwood / Removable For Maintenance
- Antimicrobial Moisture Barrier Fully Encapsulates All Foam Areas
- Leather Upholstery Not Available
- Lifetime Warranty

OPTIONS:

- EPAC-2 Black Polyester Arm Caps (Set Of 2).....\$374
- Closed Arm Panels (1861-PL / 1861-PR / 1861-PC)..... CALL FOR PRICING
- Feather Down & Polyester Pillows Available (See Page 5)
- Specify Exposed Wood Finish (See Page 6)

NOTE: All Seating Configurations Are Viewed From Left To Right Facing. Please Attach A Layout Showing Seating Configuration w/ Your Order. Assembled Units Must Be Shipped In Configurations Of 3 Or Less.

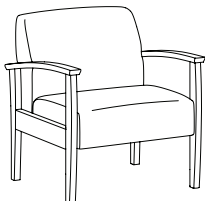
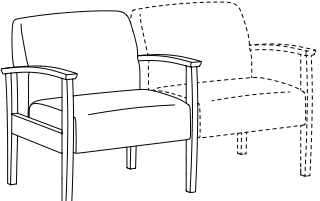
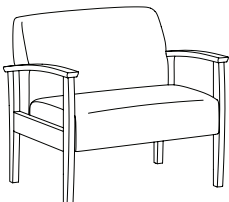
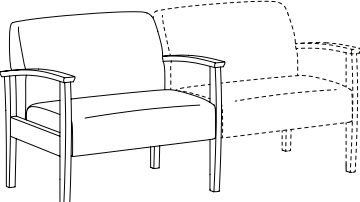
| OPEN ARM LOUNGE / TANDEM | | ITEM #: | SPECIFICATIONS GRADES LIST PRICES: | | | | | | | | | | | | |
|---|---|---------|---|------|------|--|------|------|---|------|------|------|------|-----|-----|
|  | LOUNGE CHAIR / OPEN URETHANE ARMS | | Overall: 28.5"w 29.5"d 32"h Seat: 24"w 19.5"d 18.5"h | | | Arm: 24.5"h Weight: 65 lbs. | | | COM: 2.5 yds. COL: n/a | | | | | | |
| | 1871 | COM | COL | 1 | 2 | 3 | 4 | 5 | 6 | 7 | 8 | 9 | 10 | L1 | L2 |
| | 1871-R | 1618 | N/A | 1659 | 1724 | 1789 | 1854 | 1919 | 1984 | 2049 | 2114 | 2179 | 2244 | N/A | N/A |
| <i>Tight Seat & Back / Removable Upholstery / 500 lb. Weight Capacity</i> | | | | | | | | | | | | | | | |
| <i>Replacement Upholstery Covers</i> | | | | | | | | | | | | | | | |
|  | LOUNGE CHAIR / OPEN URETHANE ARMS / ACCEPTS SEAT ON RIGHT | | Overall: 28.5"w 29.5"d 32"h Seat: 24"w 19.5"d 18.5"h | | | Arm: 24.5"h Weight: 65 lbs. | | | COM: 2.5 yds. COL: n/a | | | | | | |
| | 1871-C | COM | COL | 1 | 2 | 3 | 4 | 5 | 6 | 7 | 8 | 9 | 10 | L1 | L2 |
| | 1871-R | 1618 | N/A | 1659 | 1724 | 1789 | 1854 | 1919 | 1984 | 2049 | 2114 | 2179 | 2244 | N/A | N/A |
| <i>Tight Seat & Back / Removable Upholstery / 500 lb. Weight Capacity</i> | | | | | | | | | | | | | | | |
| <i>Replacement Upholstery Covers</i> | | | | | | | | | | | | | | | |
|  | BARIATRIC LOUNGE CHAIR / OPEN URETHANE ARMS | | Overall: 34.5"w 29.5"d 32"h Seat: 30"w 19.5"d 18.5"h | | | Arm: 24.5"h Weight: 80 lbs. | | | COM: 3 yds. COL: n/a | | | | | | |
| | 1871-X | COM | COL | 1 | 2 | 3 | 4 | 5 | 6 | 7 | 8 | 9 | 10 | L1 | L2 |
| | 1871-XR | 1947 | N/A | 2000 | 2079 | 2159 | 2238 | 2317 | 2397 | 2476 | 2556 | 2635 | 2714 | N/A | N/A |
| <i>Tight Seat & Back / Removable Upholstery / 750 lb. Weight Capacity</i> | | | | | | | | | | | | | | | |
| <i>Replacement Upholstery Covers</i> | | | | | | | | | | | | | | | |
|  | BARIATRIC LOUNGE CHAIR / OPEN URETHANE ARMS / ACCEPTS SEAT ON RIGHT | | Overall: 34.5"w 29.5"d 32"h Seat: 30"w 19.5"d 18.5"h | | | Arm: 24.5"h Weight: 80 lbs. | | | COM: 3 yds. COL: n/a | | | | | | |
| | 1871-XC | COM | COL | 1 | 2 | 3 | 4 | 5 | 6 | 7 | 8 | 9 | 10 | L1 | L2 |
| | 1871-XR | 1947 | N/A | 2000 | 2079 | 2159 | 2238 | 2317 | 2397 | 2476 | 2556 | 2635 | 2714 | N/A | N/A |
| <i>Tight Seat & Back / Removable Upholstery / 750 lb. Weight Capacity</i> | | | | | | | | | | | | | | | |
| <i>Replacement Upholstery Covers</i> | | | | | | | | | | | | | | | |

DESCRIPTION:

- Upholstery Frames: Steel, Plywood & Hardwood
- Seat: High Density Polyurethane Foam Over Strap Webbing
- Back: High Density Polyurethane Foam Over Sinuous Wire Springs
- Upholstered Covers: Attached w/ Velcro / Removable For Maintenance
- Exposed Wood Arms: Solid Hardwood / Removable For Maintenance
- Antimicrobial Moisture Barrier Fully Encapsulates All Foam Areas
- Leather Upholstery Not Available
- Lifetime Warranty

OPTIONS:

- EPAC-2 Black Polyester Arm Caps (Set Of 2).....\$374
- Closed Arm Panels (1861-PL / 1861-PR / 1861-PC)..... CALL FOR PRICING

Feather Down & Polyester Pillows Available (See Page 5)
Specify Exposed Wood Finish (See Page 6)

NOTE: All Seating Configurations Are Viewed From Left To Right Facing. Please Attach A Layout Showing Seating Configuration w/ Your Order. Assembled Units Must Be Shipped In Configurations Of 3 Or Less.

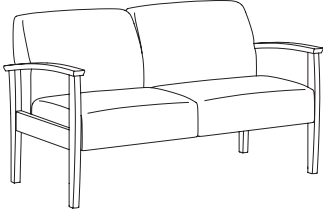
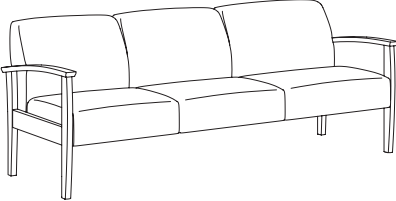
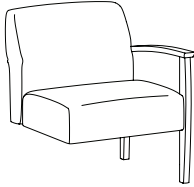
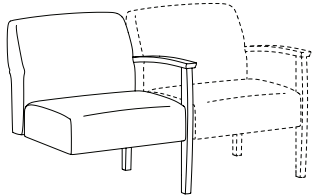
| OPEN ARM LOUNGE / TANDEM | | ITEM #: | SPECIFICATIONS GRADES LIST PRICES: | | | | | | | | | | | | | |
|---|---------------|---------|--|------------|----------|-------------------------|----------|----------|-----------------------|----------|----------|----------|----------|-----------|-----------|-----------|
| TWO PLACE SOFA / OPEN URETHANE ARMS | | | <i>Overall: 52.5"w 29.5"d 32"h</i> | | | <i>Arm: 24.5"h</i> | | | <i>COM: 4.75 yds.</i> | | | | | | | |
| | | | <i>Seat: 48"w 19.5"d 18.5"h</i> | | | <i>Weight: 140 lbs.</i> | | | <i>COL: n/a</i> | | | | | | | |
|  | | | COM | COL | 1 | 2 | 3 | 4 | 5 | 6 | 7 | 8 | 9 | 10 | L1 | L2 |
| | 1872 | | 2500 | N/A | 2623 | 2753 | 2883 | 3013 | 3143 | 3273 | 3403 | 3533 | 3662 | 3792 | N/A | N/A |
| <i>Tight Seat & Back / Removable Upholstery / 750 lb. Weight Capacity</i> | | | | | | | | | | | | | | | | |
| | 1872-R | | 294 | N/A | 563 | 705 | 847 | 989 | 1132 | 1274 | 1416 | 1558 | 1701 | 1843 | N/A | N/A |
| <i>Replacement Upholstery Covers</i> | | | | | | | | | | | | | | | | |
| THREE PLACE SOFA / OPEN URETHANE ARMS | | | <i>Overall: 76.5"w 29.5"d 32"h</i> | | | <i>Arm: 24.5"h</i> | | | <i>COM: 7 yds.</i> | | | | | | | |
| | | | <i>Seat: 72"w 19.5"d 18.5"h</i> | | | <i>Weight: 180 lbs.</i> | | | <i>COL: n/a</i> | | | | | | | |
|  | | | COM | COL | 1 | 2 | 3 | 4 | 5 | 6 | 7 | 8 | 9 | 10 | L1 | L2 |
| | 1873 | | 3104 | N/A | 3324 | 3519 | 3714 | 3909 | 4104 | 4299 | 4493 | 4688 | 4883 | 5078 | N/A | N/A |
| <i>Tight Seat & Back / Removable Upholstery / 750 lb. Weight Capacity</i> | | | | | | | | | | | | | | | | |
| | 1873-R | | 382 | N/A | 788 | 1001 | 1215 | 1428 | 1641 | 1855 | 2068 | 2281 | 2495 | 2708 | N/A | N/A |
| <i>Replacement Upholstery Covers</i> | | | | | | | | | | | | | | | | |
| ADD-A-SEAT / OPEN URETHANE ARMS | | | <i>Overall: 26.5"w 29.5"d 32"h</i> | | | <i>Arm: 24.5"h</i> | | | <i>COM: 2.5 yds.</i> | | | | | | | |
| | | | <i>Seat: 24"w 19.5"d 18.5"h</i> | | | <i>Weight: 60 lbs.</i> | | | <i>COL: n/a</i> | | | | | | | |
|  | | | COM | COL | 1 | 2 | 3 | 4 | 5 | 6 | 7 | 8 | 9 | 10 | L1 | L2 |
| | 1874 | | 1285 | N/A | 1345 | 1410 | 1475 | 1540 | 1605 | 1670 | 1735 | 1800 | 1865 | 1930 | N/A | N/A |
| <i>Tight Seat & Back / Removable Upholstery / 500 lb. Weight Capacity</i> | | | | | | | | | | | | | | | | |
| | 1874-R | | 190 | N/A | 322 | 393 | 464 | 535 | 606 | 677 | 748 | 820 | 891 | 962 | N/A | N/A |
| <i>Replacement Upholstery Covers</i> | | | | | | | | | | | | | | | | |
| ADD-A-SEAT / OPEN URETHANE ARMS / ACCEPTS SEAT ON RIGHT | | | <i>Overall: 26.5"w 29.5"d 32"h</i> | | | <i>Arm: 24.5"h</i> | | | <i>COM: 2.5 yds.</i> | | | | | | | |
| | | | <i>Seat: 24"w 19.5"d 18.5"h</i> | | | <i>Weight: 60 lbs.</i> | | | <i>COL: n/a</i> | | | | | | | |
|  | | | COM | COL | 1 | 2 | 3 | 4 | 5 | 6 | 7 | 8 | 9 | 10 | L1 | L2 |
| | 1874-C | | 1285 | N/A | 1345 | 1410 | 1475 | 1540 | 1605 | 1670 | 1735 | 1800 | 1865 | 1930 | N/A | N/A |
| <i>Tight Seat & Back / Removable Upholstery / 500 lb. Weight Capacity</i> | | | | | | | | | | | | | | | | |
| | 1874-R | | 190 | N/A | 322 | 393 | 464 | 535 | 606 | 677 | 748 | 820 | 891 | 962 | N/A | N/A |
| <i>Replacement Upholstery Covers</i> | | | | | | | | | | | | | | | | |

DESCRIPTION:

- Upholstery Frames: Steel, Plywood & Hardwood
- Seat: High Density Polyurethane Foam Over Strap Webbing
- Back: High Density Polyurethane Foam Over Sinuous Wire Springs
- Upholstered Covers: Attached w/ Velcro / Removable For Maintenance
- Exposed Wood Arms: Solid Hardwood / Removable For Maintenance
- Antimicrobial Moisture Barrier Fully Encapsulates All Foam Areas
- Leather Upholstery Not Available
- Lifetime Warranty

OPTIONS:

EPAC-2 Black Polyester Arm Caps (Set Of 2).....\$374
 Closed Arm Panels (1861-PL / 1861-PR / 1861-PC)..... CALL FOR PRICING

Feather Down & Polyester Pillows Available (See Page 5)
 Specify Exposed Wood Finish (See Page 6)

NOTE: All Seating Configurations Are Viewed From Left To Right Facing. Please Attach A Layout Showing Seating Configuration w/ Your Order. Assembled Units Must Be Shipped In Configurations Of 3 Or Less.

OPEN ARM LOUNGE / TANDEM

ITEM #:

SPECIFICATIONS | GRADES | LIST PRICES:

BARIATRIC ADD-A-SEAT / OPEN URETHANE ARMS

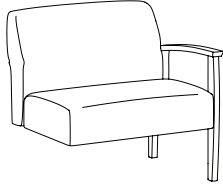



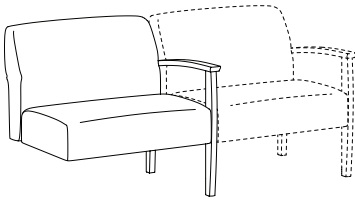

| | | | | | | | | | | | | | |
|---|------------|------------------------------------|----------|------------------------|----------|--------------------|----------|----------|----------|----------|-----------|-----------|-----------|
| | | Overall: 32.5"w 29.5"d 32"h | | Arm: 24.5"h | | COM: 3 yds. | | | | | | | |
| | | Seat: 30"w 19.5"d 18.5"h | | Weight: 75 lbs. | | COL: n/a | | | | | | | |
| COM | COL | 1 | 2 | 3 | 4 | 5 | 6 | 7 | 8 | 9 | 10 | L1 | L2 |
| 1874-X | N/A | 1686 | 1765 | 1845 | 1924 | 2003 | 2083 | 2162 | 2241 | 2321 | 2400 | N/A | N/A |
| <i>Tight Seat & Back / Removable Upholstery / 750 lb. Weight Capacity</i> | | | | | | | | | | | | | |
| 1874-XR | N/A | 360 | 446 | 533 | 620 | 707 | 794 | 881 | 968 | 1055 | 1142 | N/A | N/A |
| <i>Replacement Upholstery Covers</i> | | | | | | | | | | | | | |

BARIATRIC ADD-A-SEAT / OPEN URETHANE ARMS / ACCEPTS SEAT ON RIGHT



| | | | | | | | | | | | | | |
|---|------------|------------------------------------|----------|------------------------|----------|--------------------|----------|----------|----------|----------|-----------|-----------|-----------|
| | | Overall: 32.5"w 29.5"d 32"h | | Arm: 24.5"h | | COM: 3 yds. | | | | | | | |
| | | Seat: 30"w 19.5"d 18.5"h | | Weight: 75 lbs. | | COL: n/a | | | | | | | |
| COM | COL | 1 | 2 | 3 | 4 | 5 | 6 | 7 | 8 | 9 | 10 | L1 | L2 |
| 1874-XC | N/A | 1686 | 1765 | 1845 | 1924 | 2003 | 2083 | 2162 | 2241 | 2321 | 2400 | N/A | N/A |
| <i>Tight Seat & Back / Removable Upholstery / 750 lb. Weight Capacity</i> | | | | | | | | | | | | | |
| 1874-XR | N/A | 360 | 446 | 533 | 620 | 707 | 794 | 881 | 968 | 1055 | 1142 | N/A | N/A |
| <i>Replacement Upholstery Covers</i> | | | | | | | | | | | | | |

| ARM CAPS / TABLETS | OPTION #: | SPECIFICATIONS LIST PRICES AVAILABILITY: |
|---|--|---|
| <p>SOLID WOOD ARM CAPS</p>  | <p>EWAC</p> | <p>Overall: 2.75"w 29"d 1.125"h</p> <hr/> <p>\$243 (Set Of 2) SOLID WOOD <i>(Specify Finish)</i></p> <p>Available: <i>Facelift Evolve Fully Upholstered Lounge & Tandem</i></p> |
| <p>URETHANE / POLYESTER ARM CAPS</p>  | <p>EUAC</p> <p>EPAC-2</p> | <p>Overall: 2.75"w 29"d 1.125"h</p> <hr/> <p>\$249 (Set Of 2) URETHANE <i>(1841-1844 Black Urethane)</i></p> <p>\$374 (Set Of 2) POLYESTER <i>(1841-1844 / 1871-1874)</i></p> <p><i>Black Polyester Arm Cap (Additional Colors Available)</i></p> <p>Available: <i>Facelift Evolve Fully Upholstered Lounge & Tandem</i></p> |
| <p>TABLET ARMS / CUP HOLDER</p>  <p>Laminate Tablet Arm Shown w/ Cup Holder</p> <p>Veneer Tablet Arm Shown w/ Cup Holder</p> <p>Solid Surface Tablet Arm Shown w/ Cup Holder</p> | <p>TA-L</p> <p>TA-V</p> <p>TA-C</p> <p>CH-1</p> <p>CH-2</p> | <p>Overall: 14" Diameter .75"h</p> <hr/> <p>\$509 <i>Tablet Arm With 360° Rotation - High Pressure Laminate. (Specify Laminate / Specify Left Or Right Facing Arm Location)</i></p> <p>\$580 <i>Tablet Arm With 360° Rotation - Sunburst Cherry Veneer. (Specify Finish / Specify Left Or Right Facing Arm Location)</i></p> <p>\$698 <i>Tablet Arm With 360° Rotation - White Solid Surface. (Available In White Only / Specify Left Or Right Facing Arm Location)</i></p> <p>\$129 <i>Black Plastic Cup Holder (Only Available If Used With Tablet Arm)</i></p> <p>\$186 <i>Spun Aluminum Cup Holder (Only Available If Used With Tablet Arm)</i></p> <p>Available: <i>Facelift Evolve Lounge / Tandem Collection</i></p> |
| <p>FOLD DOWN TABLET ARM</p>  | <p>FDTA-L</p> <p>FDTA-V</p> <p>FDTA-C</p> | <p>Overall: 14" Diameter .75"h</p> <hr/> <p>\$1065 <i>Tablet Arm With 360° Rotation - High Pressure Laminate. (Specify Laminate / Specify Left Or Right Facing Arm Location)</i></p> <p>\$1136 <i>Tablet Arm With 360° Rotation - Sunburst Cherry Veneer. (Specify Finish / Specify Left Or Right Facing Arm Location)</i></p> <p>\$1278 <i>Tablet Arm With 360° Rotation - White Solid Surface. (Available In White Only / Specify Left Or Right Facing Arm Location)</i></p> <p>Available: <i>Facelift Evolve Lounge / Tandem Collection</i></p> |

| TABLETS / POWER / LEGS / COVERS | OPTION #: | SPECIFICATIONS LIST PRICES AVAILABILITY: |
|---|--|--|
| <p>DOUBLE ARTICULATING / SWIVEL TABLET ARM</p>  <p>ATA-L Double Articulating / Swivel Tablet Arm</p>  <p>ATA-L w/ CH-1 Black Plastic Cup Holder</p> | <p>Overall: 14" Diameter .75"h</p> <hr/> <p>ATA-L \$983 <i>Tablet Arm With 360° Rotation - High Pressure Laminate. (Specify Laminate / Specify Left Or Right Facing Arm Location)</i></p> <p>ATA-V \$1055 <i>Tablet Arm With 360° Rotation - Sunburst Cherry Veneer. (Specify Finish / Specify Left Or Right Facing Arm Location)</i></p> <p>ATA-C \$1173 <i>Tablet Arm With 360° Rotation - White Solid Surface. (Available In White Only / Specify Left Or Right Facing Arm Location)</i></p> <p>CH-1 \$129 <i>Black Plastic Cup Holder (Only Available If Used With Tablet Arm)</i></p> <p>CH-2 \$186 <i>Spun Aluminum Cup Holder (Only Available If Used With Tablet Arm)</i></p> <p>Available: <i>Facelift Evolve Lounge / Tandem Collection</i></p> | |
| <p>POWER / DATA MODULE</p>  <p>PM1 Power / Data Module</p>  <p>PM2 Power Module</p>  <p>USB-1 Dual Charging USB</p> | <p>PM1 Overall: 5.25"w 1.25"d 4.25"h PM2 Overall: 2"w 2"d .125"h USB-1 Overall: 2"w 2"d .125"h</p> <hr/> <p>PM1 \$859 Power/Data Module (1-Power / 1-USB 2 Port Simplex Charger Standard) <i>Vertical / Horizontal Mount Power Module. Price Varies By Socket. Contact Customer Service For Quote. (Additional Colors Available)</i></p> <p>PM2 \$238 Power Module (1-Power) <i>Spill-Proof Technology / Multiple Finish Options / Storm Color Standard (Specify Left or Right Facing)</i></p> <p>USB-1 \$238 Dual Charging USB (2 Port Simplex Charger Standard) <i>Spill-Proof Technology / 2 Amps Per Port / Multiple Finish Options / Storm Color Standard (Specify Left or Right Facing)</i></p> <p>Available: <i>Facelift Evolve Fully Upholstered Lounge</i></p> | |
| <p>BRUSHED ALUMINUM ROUND LEGS</p>  | <p>Overall: 2" Diameter 5"h</p> <hr/> <p>ARL \$353 (Set Of 4) <i>(Brushed Aluminum Finish)</i></p> <p>Available: <i>Facelift Evolve Lounge & Tandem</i></p> | |
| <p>CONTRASTING COVERS</p>  | <p>Overall: N/A</p> <hr/> <p>CC \$129 <i>NOTE: If Two Or More Upholsteries Or Leathers Are Used On Any Piece Of Furniture, Then A Contrast Charge Will Apply Per Order. When Using Trinity Upholstery, The Higher Priced Upholstery Grade Will Be Used In Pricing, Unless It's Trinity Leather With Fabric Contrast Welt, Or COM With Trinity Contrast Welt, Then Contact Customer Service For Pricing.</i></p> <p>Available: <i>Facelift Evolve Lounge & Tandem</i></p> | |

Facelift Evolve

FULLY UPHOLSTERED GUEST / TANDEM / TABLES

Effective: March 1, 2025

T R I N I T Y

Date:

Page:

Modification:

Description:

DESCRIPTION:

- Upholstery Frames: Steel, Plywood & Hardwood
- Seat: High Density Polyurethane Foam Over Strap Webbing
- Back: High Density Polyurethane Foam Over Plywood
- Upholstered Covers: Attached w/ Velcro / Removable For Maintenance
- Exposed Black Polyurethane Arm Caps Standard
- Exposed Black Polyester Legs Standard: Removable For Maintenance / Wallsaver Legs
- Antimicrobial Moisture Barrier Fully Encapsulates Seat & Back
- Leather Upholstery Not Available
- Adjustable Height Leveling Glides Standard
- Lifetime Warranty

OPTIONS:

- EPAC-1 Polyester Arm Cap (Specify Color)\$195 Each
- Specify Exposed Polyester Leg Finish (See Page 7)
- Table & Connecting Tables Available (See Facelift Evolve Guest/Tandem/Tables)

NOTE: All Seating Configurations Are Viewed From Left To Right Facing. Please Attach A Layout Showing Seating Configuration w/ Your Order. Assembled Units Must Be Shipped In Configurations Of 3 Or Less.

GUEST / TANDEM

ITEM #:

SPECIFICATIONS | GRADES | LIST PRICES:

FULLY UPHOLSTERED CHAIR

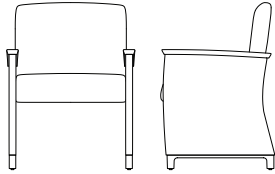

Overall: 23.5"w 24"d 34"h **Arm:** 25"h **COM:** 3.75 yds.
Seat: 20"w 19"d 18.5"h **Weight:** 55 lbs. **COL:** n/a

| COM | COL | 1 | 2 | 3 | 4 | 5 | 6 | 7 | 8 | 9 | 10 | L1 | L2 |
|---|-----|------|------|------|------|------|------|------|------|------|------|-----|-----|
| 1880 | N/A | 1529 | 1626 | 1722 | 1818 | 1914 | 2010 | 2107 | 2203 | 2299 | 2395 | N/A | N/A |
| <i>Closed Back / Tight Seat & Back / Removable Upholstery / 350 lb. Weight Capacity</i> | | | | | | | | | | | | | |
| 1880-R | N/A | 358 | 474 | 589 | 704 | 820 | 935 | 1057 | 1179 | 1302 | 1424 | N/A | N/A |
| <i>Replacement Upholstery Covers</i> | | | | | | | | | | | | | |

FULLY UPHOLSTERED CHAIR / ACCEPTS CHAIR ON RIGHT

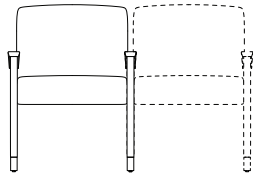

Overall: 23.5"w 24"d 34"h **Arm:** 25"h **COM:** 3.75 yds.
Seat: 20"w 19"d 18.5"h **Weight:** 55 lbs. **COL:** n/a

| COM | COL | 1 | 2 | 3 | 4 | 5 | 6 | 7 | 8 | 9 | 10 | L1 | L2 |
|---|-----|------|------|------|------|------|------|------|------|------|------|-----|-----|
| 1880-C | N/A | 1529 | 1626 | 1722 | 1818 | 1914 | 2010 | 2107 | 2203 | 2299 | 2395 | N/A | N/A |
| <i>Closed Back / Tight Seat & Back / Removable Upholstery / 350 lb. Weight Capacity</i> | | | | | | | | | | | | | |
| 1880-R | N/A | 358 | 474 | 589 | 704 | 820 | 935 | 1057 | 1179 | 1302 | 1424 | N/A | N/A |
| <i>Replacement Upholstery Covers</i> | | | | | | | | | | | | | |

FULLY UPHOLSTERED CHAIR / ACCEPTS TABLE ON RIGHT

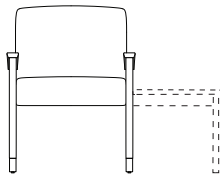

Overall: 23.5"w 24"d 34"h **Arm:** 25"h **COM:** 3.75 yds.
Seat: 20"w 19"d 18.5"h **Weight:** 55 lbs. **COL:** n/a

| COM | COL | 1 | 2 | 3 | 4 | 5 | 6 | 7 | 8 | 9 | 10 | L1 | L2 |
|---|-----|------|------|------|------|------|------|------|------|------|------|-----|-----|
| 1880-T | N/A | 1529 | 1626 | 1722 | 1818 | 1914 | 2010 | 2107 | 2203 | 2299 | 2395 | N/A | N/A |
| <i>Closed Back / Tight Seat & Back / Removable Upholstery / 350 lb. Weight Capacity</i> | | | | | | | | | | | | | |
| 1880-R | N/A | 358 | 474 | 589 | 704 | 820 | 935 | 1057 | 1179 | 1302 | 1424 | N/A | N/A |
| <i>Replacement Upholstery Covers</i> | | | | | | | | | | | | | |

DESCRIPTION:

- Upholstery Frames: Steel, Plywood & Hardwood
- Seat: High Density Polyurethane Foam Over Strap Webbing
- Back: High Density Polyurethane Foam Over Plywood
- Upholstered Covers: Attached w/ Velcro / Removable For Maintenance
- Exposed Black Polyurethane Arm Caps Standard
- Exposed Black Polyester Legs Standard: Removable For Maintenance / Wallsaver Legs
- Antimicrobial Moisture Barrier Fully Encapsulates Seat & Back
- Leather Upholstery Not Available
- Adjustable Height Leveling Glides Standard
- Lifetime Warranty

OPTIONS:

- EPAC-1 Polyester Arm Cap (Specify Color)\$195 Each
- Specify Exposed Polyester Leg Finish (See Page 7)
- Table & Connecting Tables Available (See Facelift Evolve Guest/Tandem/Tables)

NOTE: All Seating Configurations Are Viewed From Left To Right Facing. Please Attach A Layout Showing Seating Configuration w/ Your Order. Assembled Units Must Be Shipped In Configurations Of 3 Or Less.

TANDEM

ITEM #: SPECIFICATIONS | GRADES | LIST PRICES:

ADD-A-SEAT

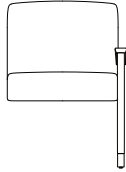

| | | | | | | | | | | | | | |
|---|------------|-----------------------------------|----------|------------------------|----------|-----------------------|----------|----------|----------|----------|-----------|-----------|-----------|
| | | Overall: 21.75"w 24"d 34"h | | Arm: 25"h | | COM: 2.75 yds. | | | | | | | |
| | | Seat: 20"w 19"d 18.5"h | | Weight: 50 lbs. | | COL: n/a | | | | | | | |
| COM | COL | 1 | 2 | 3 | 4 | 5 | 6 | 7 | 8 | 9 | 10 | L1 | L2 |
| 1881 | N/A | 1095 | 1164 | 1233 | 1302 | 1370 | 1439 | 1508 | 1576 | 1645 | 1714 | N/A | N/A |
| <i>Closed Back / Tight Seat & Back / Removable Upholstery / 350 lb. Weight Capacity</i> | | | | | | | | | | | | | |
| 1881-R | N/A | 268 | 351 | 433 | 516 | 598 | 681 | 770 | 859 | 948 | 1037 | N/A | N/A |
| <i>Replacement Upholstery Covers</i> | | | | | | | | | | | | | |

ADD-A-SEAT / ACCEPTS SEAT ON RIGHT

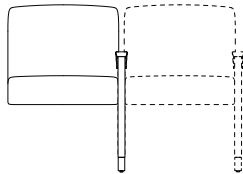

| | | | | | | | | | | | | | |
|---|------------|-----------------------------------|----------|------------------------|----------|-----------------------|----------|----------|----------|----------|-----------|-----------|-----------|
| | | Overall: 21.75"w 24"d 34"h | | Arm: 25"h | | COM: 2.75 yds. | | | | | | | |
| | | Seat: 20"w 19"d 18.5"h | | Weight: 50 lbs. | | COL: n/a | | | | | | | |
| COM | COL | 1 | 2 | 3 | 4 | 5 | 6 | 7 | 8 | 9 | 10 | L1 | L2 |
| 1881-C | N/A | 1095 | 1164 | 1233 | 1302 | 1370 | 1439 | 1508 | 1576 | 1645 | 1714 | N/A | N/A |
| <i>Closed Back / Tight Seat & Back / Removable Upholstery / 350 lb. Weight Capacity</i> | | | | | | | | | | | | | |
| 1881-R | N/A | 268 | 351 | 433 | 516 | 598 | 681 | 770 | 859 | 948 | 1037 | N/A | N/A |
| <i>Replacement Upholstery Covers</i> | | | | | | | | | | | | | |

ADD-A-SEAT / ACCEPTS TABLE ON RIGHT

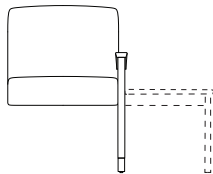

| | | | | | | | | | | | | | |
|---|------------|-----------------------------------|----------|------------------------|----------|-----------------------|----------|----------|----------|----------|-----------|-----------|-----------|
| | | Overall: 21.75"w 24"d 34"h | | Arm: 25"h | | COM: 2.75 yds. | | | | | | | |
| | | Seat: 20"w 19"d 18.5"h | | Weight: 50 lbs. | | COL: n/a | | | | | | | |
| COM | COL | 1 | 2 | 3 | 4 | 5 | 6 | 7 | 8 | 9 | 10 | L1 | L2 |
| 1881-T | N/A | 1095 | 1164 | 1233 | 1302 | 1370 | 1439 | 1508 | 1576 | 1645 | 1714 | N/A | N/A |
| <i>Closed Back / Tight Seat & Back / Removable Upholstery / 350 lb. Weight Capacity</i> | | | | | | | | | | | | | |
| 1881-R | N/A | 268 | 351 | 433 | 516 | 598 | 681 | 770 | 859 | 948 | 1037 | N/A | N/A |
| <i>Replacement Upholstery Covers</i> | | | | | | | | | | | | | |

DESCRIPTION:

- Upholstery Frames: Steel, Plywood & Hardwood
- Seat: High Density Polyurethane Foam Over Strap Webbing
- Back: High Density Polyurethane Foam Over Plywood
- Upholstered Covers: Attached w/ Velcro / Removable For Maintenance
- Exposed Black Polyurethane Arm Caps Standard
- Exposed Black Polyester Legs Standard: Removable For Maintenance / Wallsaver Legs
- Antimicrobial Moisture Barrier Fully Encapsulates Seat & Back
- Leather Upholstery Not Available
- Adjustable Height Leveling Glides Standard
- Lifetime Warranty

OPTIONS:

- EPAC-1 Polyester Arm Cap (Specify Color)\$195 Each
- Specify Exposed Polyester Leg Finish (See Page 7)
- Table & Connecting Tables Available (See Facelift Evolve Guest/Tandem/Tables)

NOTE: All Seating Configurations Are Viewed From Left To Right Facing. Please Attach A Layout Showing Seating Configuration w/ Your Order. Assembled Units Must Be Shipped In Configurations Of 3 Or Less.

BARIATRIC / TANDEM

ITEM #:

SPECIFICATIONS | GRADES | LIST PRICES:

FULLY UPHOLSTERED BARIATRIC CHAIR

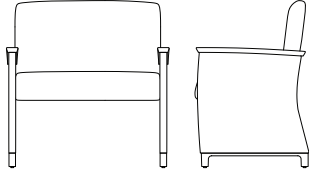

Overall: 33.5"w 24"d 34"h **Arm:** 25"h **COM:** 4.25 yds.
Seat: 30"w 19"d 18.5"h **Weight:** 65 lbs. **COL:** n/a

| COM | COL | 1 | 2 | 3 | 4 | 5 | 6 | 7 | 8 | 9 | 10 | L1 | L2 |
|---|-----|------|------|------|------|------|------|------|------|------|------|-----|-----|
| 1703 | N/A | 1830 | 1940 | 2050 | 2160 | 2270 | 2380 | 2490 | 2600 | 2710 | 2820 | N/A | N/A |
| <i>Closed Back / Tight Seat & Back / Removable Upholstery / 500 lb. Weight Capacity</i> | | | | | | | | | | | | | |
| 1882 | | | | | | | | | | | | | |
| 148 | N/A | 404 | 536 | 668 | 800 | 932 | 1064 | 1196 | 1328 | 1460 | 1592 | N/A | N/A |
| <i>Replacement Upholstery Covers</i> | | | | | | | | | | | | | |

FULLY UPHOLSTERED BARIATRIC CHAIR / ACCEPTS CHAIR ON RIGHT

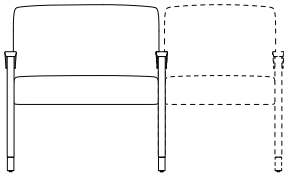

Overall: 33.5"w 24"d 34"h **Arm:** 25"h **COM:** 4.25 yds.
Seat: 30"w 19"d 18.5"h **Weight:** 65 lbs. **COL:** n/a

| COM | COL | 1 | 2 | 3 | 4 | 5 | 6 | 7 | 8 | 9 | 10 | L1 | L2 |
|---|-----|------|------|------|------|------|------|------|------|------|------|-----|-----|
| 1703 | N/A | 1830 | 1940 | 2050 | 2160 | 2270 | 2380 | 2490 | 2600 | 2710 | 2820 | N/A | N/A |
| <i>Closed Back / Tight Seat & Back / Removable Upholstery / 500 lb. Weight Capacity</i> | | | | | | | | | | | | | |
| 1882-C | | | | | | | | | | | | | |
| 148 | N/A | 404 | 536 | 668 | 800 | 932 | 1064 | 1196 | 1328 | 1460 | 1592 | N/A | N/A |
| <i>Replacement Upholstery Covers</i> | | | | | | | | | | | | | |

FULLY UPHOLSTERED BARIATRIC CHAIR / ACCEPTS TABLE ON RIGHT

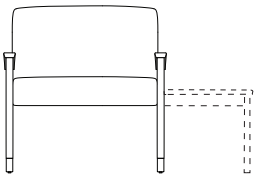

Overall: 33.5"w 24"d 34"h **Arm:** 25"h **COM:** 4.25 yds.
Seat: 30"w 19"d 18.5"h **Weight:** 65 lbs. **COL:** n/a

| COM | COL | 1 | 2 | 3 | 4 | 5 | 6 | 7 | 8 | 9 | 10 | L1 | L2 |
|---|-----|------|------|------|------|------|------|------|------|------|------|-----|-----|
| 1703 | N/A | 1830 | 1940 | 2050 | 2160 | 2270 | 2380 | 2490 | 2600 | 2710 | 2820 | N/A | N/A |
| <i>Closed Back / Tight Seat & Back / Removable Upholstery / 500 lb. Weight Capacity</i> | | | | | | | | | | | | | |
| 1882-T | | | | | | | | | | | | | |
| 148 | N/A | 404 | 536 | 668 | 800 | 932 | 1064 | 1196 | 1328 | 1460 | 1592 | N/A | N/A |
| <i>Replacement Upholstery Covers</i> | | | | | | | | | | | | | |

DESCRIPTION:

- Upholstery Frames: Steel, Plywood & Hardwood
- Seat: High Density Polyurethane Foam Over Strap Webbing
- Back: High Density Polyurethane Foam Over Plywood
- Upholstered Covers: Attached w/ Velcro / Removable For Maintenance
- Exposed Black Polyurethane Arm Caps Standard
- Exposed Black Polyester Legs Standard: Removable For Maintenance / Wallsaver Legs
- Antimicrobial Moisture Barrier Fully Encapsulates Seat & Back
- Leather Upholstery Not Available
- Adjustable Height Leveling Glides Standard
- Lifetime Warranty

OPTIONS:

- EPAC-1 Polyester Arm Cap (Specify Color)\$195 Each
- Specify Exposed Polyester Leg Finish (See Page 7)
- Table & Connecting Tables Available (See Facelift Evolve Guest/Tandem/Tables)

NOTE: All Seating Configurations Are Viewed From Left To Right Facing. Please Attach A Layout Showing Seating Configuration w/ Your Order. Assembled Units Must Be Shipped In Configurations Of 3 Or Less.

BARIATRIC / TANDEM

ITEM #:

SPECIFICATIONS | GRADES | LIST PRICES:

BARIATRIC ADD-A-SEAT

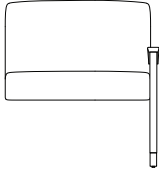

Overall: 31.75"w 24"d 34"h **Arm:** 25"h **COM:** 3.25 yds.
Seat: 30"w 19"d 18.5"h **Weight:** 62 lbs. **COL:** n/a

| COM | COL | 1 | 2 | 3 | 4 | 5 | 6 | 7 | 8 | 9 | 10 | L1 | L2 |
|---|-----|------|------|------|------|------|------|------|------|------|------|-----|-----|
| 1883 | N/A | 1392 | 1468 | 1543 | 1619 | 1695 | 1770 | 1846 | 1921 | 1997 | 2073 | N/A | N/A |
| <i>Closed Back / Tight Seat & Back / Removable Upholstery / 500 lb. Weight Capacity</i> | | | | | | | | | | | | | |
| 1883-R | N/A | 300 | 391 | 481 | 572 | 663 | 754 | 844 | 935 | 1026 | 1116 | N/A | N/A |
| <i>Replacement Upholstery Covers</i> | | | | | | | | | | | | | |

BARIATRIC ADD-A-SEAT / ACCEPTS SEAT ON RIGHT

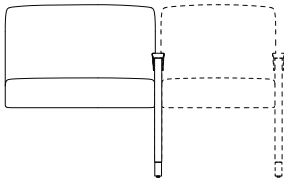

Overall: 31.75"w 24"d 34"h **Arm:** 25"h **COM:** 3.25 yds.
Seat: 30"w 19"d 18.5"h **Weight:** 62 lbs. **COL:** n/a

| COM | COL | 1 | 2 | 3 | 4 | 5 | 6 | 7 | 8 | 9 | 10 | L1 | L2 |
|---|-----|------|------|------|------|------|------|------|------|------|------|-----|-----|
| 1883-C | N/A | 1392 | 1468 | 1543 | 1619 | 1695 | 1770 | 1846 | 1921 | 1997 | 2073 | N/A | N/A |
| <i>Closed Back / Tight Seat & Back / Removable Upholstery / 500 lb. Weight Capacity</i> | | | | | | | | | | | | | |
| 1883-R | N/A | 300 | 391 | 481 | 572 | 663 | 754 | 844 | 935 | 1026 | 1116 | N/A | N/A |
| <i>Replacement Upholstery Covers</i> | | | | | | | | | | | | | |

BARIATRIC ADD-A-SEAT / ACCEPTS TABLE ON RIGHT

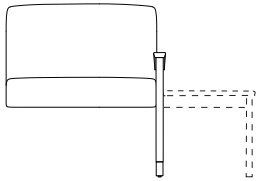

Overall: 31.75"w 24"d 34"h **Arm:** 25"h **COM:** 3.25 yds.
Seat: 30"w 19"d 18.5"h **Weight:** 62 lbs. **COL:** n/a

| COM | COL | 1 | 2 | 3 | 4 | 5 | 6 | 7 | 8 | 9 | 10 | L1 | L2 |
|---|-----|------|------|------|------|------|------|------|------|------|------|-----|-----|
| 1883-T | N/A | 1392 | 1468 | 1543 | 1619 | 1695 | 1770 | 1846 | 1921 | 1997 | 2073 | N/A | N/A |
| <i>Closed Back / Tight Seat & Back / Removable Upholstery / 500 lb. Weight Capacity</i> | | | | | | | | | | | | | |
| 1883-R | N/A | 300 | 391 | 481 | 572 | 663 | 754 | 844 | 935 | 1026 | 1116 | N/A | N/A |
| <i>Replacement Upholstery Covers</i> | | | | | | | | | | | | | |

DESCRIPTION:

- Upholstery Frames: Steel, Plywood & Hardwood
- Seat: High Density Polyurethane Foam Over Strap Webbing
- Back: High Density Polyurethane Foam Over Plywood
- Upholstered Covers: Attached w/ Velcro / Removable For Maintenance
- Exposed Black Polyurethane Arm Caps Standard
- Exposed Black Polyester Legs Standard: Removable For Maintenance / Wallsaver Legs
- Antimicrobial Moisture Barrier Fully Encapsulates Seat & Back
- Leather Upholstery Not Available
- Adjustable Height Leveling Glides Standard
- Lifetime Warranty

OPTIONS:

EPAC-1 Polyester Arm Cap (Specify Color)\$195 Each

Specify Exposed Polyester Leg Finish (See Page 7)
Table & Connecting Tables Available (See Facelift Evolve Guest/Tandem/Tables)

NOTE: All Seating Configurations Are Viewed From Left To Right Facing. Please Attach A Layout Showing Seating Configuration w/ Your Order. Assembled Units Must Be Shipped In Configurations Of 3 Or Less.

GUEST / TANDEM

ITEM #:

SPECIFICATIONS | GRADES | LIST PRICES:

FULLY UPHOLSTERED TWO PLACE SOFA

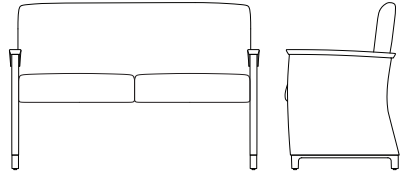

1884

1884-R

Overall: 51.5"w 24"d 34"h **Arm:** 25"h **COM:** 5.5 yds.
Seat: 48"w 19"d 18.5"h **Weight:** 75 lbs. **COL:** n/a

| COM | COL | 1 | 2 | 3 | 4 | 5 | 6 | 7 | 8 | 9 | 10 | L1 | L2 |
|---|-----|------|------|------|------|------|------|------|------|------|------|-----|-----|
| 2112 | N/A | 2285 | 2429 | 2574 | 2718 | 2862 | 3007 | 3151 | 3295 | 3440 | 3584 | N/A | N/A |
| <i>Closed Back / Tight Seat & Back / Removable Upholstery / 750 lb. Weight Capacity</i> | | | | | | | | | | | | | |
| 182 | N/A | 519 | 692 | 865 | 1038 | 1212 | 1385 | 1558 | 1731 | 1904 | 2077 | N/A | N/A |
| <i>Replacement Upholstery Covers</i> | | | | | | | | | | | | | |

FULLY UPHOLSTERED TWO PLACE SOFA / ACCEPTS CHAIR ON RIGHT

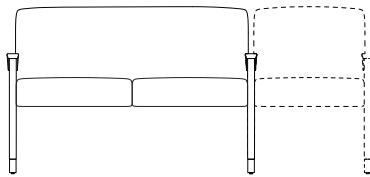

1884-C

1884-R

Overall: 51.5"w 24"d 34"h **Arm:** 25"h **COM:** 5.5 yds.
Seat: 48"w 19"d 18.5"h **Weight:** 75 lbs. **COL:** n/a

| COM | COL | 1 | 2 | 3 | 4 | 5 | 6 | 7 | 8 | 9 | 10 | L1 | L2 |
|---|-----|------|------|------|------|------|------|------|------|------|------|-----|-----|
| 2112 | N/A | 2285 | 2429 | 2574 | 2718 | 2862 | 3007 | 3151 | 3295 | 3440 | 3584 | N/A | N/A |
| <i>Closed Back / Tight Seat & Back / Removable Upholstery / 750 lb. Weight Capacity</i> | | | | | | | | | | | | | |
| 182 | N/A | 519 | 692 | 865 | 1038 | 1212 | 1385 | 1558 | 1731 | 1904 | 2077 | N/A | N/A |
| <i>Replacement Upholstery Covers</i> | | | | | | | | | | | | | |

FULLY UPHOLSTERED TWO PLACE SOFA / ACCEPTS TABLE ON RIGHT

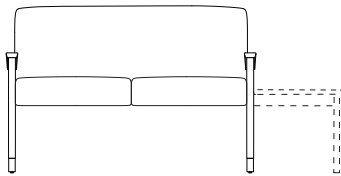

1884-T

1884-R

Overall: 51.5"w 24"d 34"h **Arm:** 25"h **COM:** 5.5 yds.
Seat: 48"w 19"d 18.5"h **Weight:** 75 lbs. **COL:** n/a

| COM | COL | 1 | 2 | 3 | 4 | 5 | 6 | 7 | 8 | 9 | 10 | L1 | L2 |
|---|-----|------|------|------|------|------|------|------|------|------|------|-----|-----|
| 2112 | N/A | 2285 | 2429 | 2574 | 2718 | 2862 | 3007 | 3151 | 3295 | 3440 | 3584 | N/A | N/A |
| <i>Closed Back / Tight Seat & Back / Removable Upholstery / 750 lb. Weight Capacity</i> | | | | | | | | | | | | | |
| 182 | N/A | 519 | 692 | 865 | 1038 | 1212 | 1385 | 1558 | 1731 | 1904 | 2077 | N/A | N/A |
| <i>Replacement Upholstery Covers</i> | | | | | | | | | | | | | |

DESCRIPTION:

- Upholstery Frames: Steel, Plywood & Hardwood
- Seat: High Density Polyurethane Foam Over Strap Webbing
- Back: High Density Polyurethane Foam Over Plywood
- Upholstered Covers: Attached w/ Velcro / Removable For Maintenance
- Exposed Black Polyurethane Arm Caps Standard
- Exposed Black Polyester Legs Standard: Removable For Maintenance / Wallsaver Legs
- Antimicrobial Moisture Barrier Fully Encapsulates Seat & Back
- Leather Upholstery Not Available
- Adjustable Height Leveling Glides Standard
- Lifetime Warranty

OPTIONS:

- EPAC-1 Polyester Arm Cap (Specify Color)\$195 Each
- Specify Exposed Polyester Leg Finish (See Page 7)
- Table & Connecting Tables Available (See Facelift Evolve Guest/Tandem/Tables)

NOTE: All Seating Configurations Are Viewed From Left To Right Facing. Please Attach A Layout Showing Seating Configuration w/ Your Order. Assembled Units Must Be Shipped In Configurations Of 3 Or Less.

GUEST / TANDEM

ITEM #:

SPECIFICATIONS | GRADES | LIST PRICES:

TWO PLACE ADD-A-SEAT

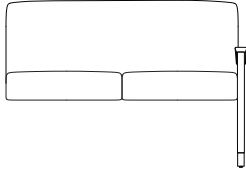

Overall: 49.75" w 24" d 34" h **Arm:** 25" h **COM:** 4.5 yds.
Seat: 48" w 19" d 18.5" h **Weight:** 72 lbs. **COL:** n/a

| COM | COL | 1 | 2 | 3 | 4 | 5 | 6 | 7 | 8 | 9 | 10 | L1 | L2 |
|---|-----|------|------|------|------|------|------|------|------|------|------|-----|-----|
| 1885 | N/A | 1166 | 1283 | 1400 | 1517 | 1634 | 1750 | 1867 | 1984 | 2101 | 2218 | N/A | N/A |
| <i>Closed Back / Tight Seat & Back / Removable Upholstery / 750 lb. Weight Capacity</i> | | | | | | | | | | | | | |
| 1885-R | N/A | 425 | 566 | 706 | 846 | 986 | 1126 | 1267 | 1407 | 1547 | 1687 | N/A | N/A |
| <i>Replacement Upholstery Covers</i> | | | | | | | | | | | | | |

TWO PLACE ADD-A-SEAT / ACCEPTS SEAT ON RIGHT

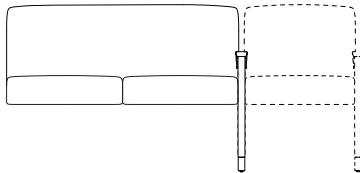

Overall: 49.75" w 24" d 34" h **Arm:** 25" h **COM:** 4.5 yds.
Seat: 48" w 19" d 18.5" h **Weight:** 72 lbs. **COL:** n/a

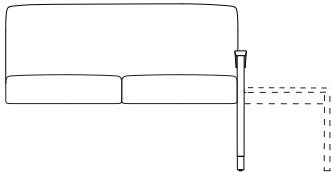

| COM | COL | 1 | 2 | 3 | 4 | 5 | 6 | 7 | 8 | 9 | 10 | L1 | L2 |
|---|-----|------|------|------|------|------|------|------|------|------|------|-----|-----|
| 1885-C | N/A | 1166 | 1283 | 1400 | 1517 | 1634 | 1750 | 1867 | 1984 | 2101 | 2218 | N/A | N/A |
| <i>Closed Back / Tight Seat & Back / Removable Upholstery / 750 lb. Weight Capacity</i> | | | | | | | | | | | | | |
| 1885-R | N/A | 425 | 566 | 706 | 846 | 986 | 1126 | 1267 | 1407 | 1547 | 1687 | N/A | N/A |
| <i>Replacement Upholstery Covers</i> | | | | | | | | | | | | | |

TWO PLACE ADD-A-SEAT / ACCEPTS TABLE ON RIGHT



Overall: 49.75" w 24" d 34" h **Arm:** 25" h **COM:** 4.5 yds.
Seat: 48" w 19" d 18.5" h **Weight:** 72 lbs. **COL:** n/a

| COM | COL | 1 | 2 | 3 | 4 | 5 | 6 | 7 | 8 | 9 | 10 | L1 | L2 |
|---|-----|------|------|------|------|------|------|------|------|------|------|-----|-----|
| 1885-T | N/A | 1166 | 1283 | 1400 | 1517 | 1634 | 1750 | 1867 | 1984 | 2101 | 2218 | N/A | N/A |
| <i>Closed Back / Tight Seat & Back / Removable Upholstery / 750 lb. Weight Capacity</i> | | | | | | | | | | | | | |
| 1885-R | N/A | 425 | 566 | 706 | 846 | 986 | 1126 | 1267 | 1407 | 1547 | 1687 | N/A | N/A |
| <i>Replacement Upholstery Covers</i> | | | | | | | | | | | | | |

| ARM CAPS / COVERS | OPTION #: | SPECIFICATIONS LIST PRICES AVAILABILITY: |
|--|--|--|
| <p data-bbox="87 178 292 210">POLYESTER ARM CAPS</p>  | <p data-bbox="570 178 828 210"><i>Overall: 2.75"w 22.5"d 1.125"h</i></p> <hr/> <p data-bbox="570 262 844 325">EPAC-1 \$195 Each - POLYESTER <i>Polyester Arm Cap (Specify Exposed)</i></p> <p data-bbox="570 367 974 399"><i>Available: Facelift Evolve Fully Upholstered Collection</i></p> | |
| <p data-bbox="87 640 292 672">CONTRASTING COVERS</p>  | <p data-bbox="570 640 682 672"><i>Overall: N/A</i></p> <hr/> <p data-bbox="570 724 1477 829">CC \$129 <i>NOTE: If Two Or More Upholsteries Or Leathers Are Used On Any Piece Of Furniture, Then A Contrast Charge Will Apply Per Order. When Using Trinity Upholstery, The Higher Priced Upholstery Grade Will Be Used In Pricing, Unless It's Trinity Leather With Fabric Contrast Welt, Or COM With Trinity Contrast Welt, Then Contact Customer Service For Pricing.</i></p> <p data-bbox="570 871 974 903"><i>Available: Facelift Evolve Fully Upholstered Collection</i></p> | |

T R I N I T Y

Established 1984



T R I N I T Y

P.O. Box 150
Trinity, NC 27370
T 336.472.6660 F 336.475.0037 TF 855.311.6660
sales@trinityfurniture.com www.trinityfurniture.com